

MOUNTING AND OPERATING INSTRUCTIONS



EB 8332-2 EN

Translation of original instructions



Type 3375 Electric Actuator Version with positioner

Firmware version 3.12



Edition August 2016

Note on these mounting and operating instructions

These mounting and operating instructions assist you in mounting and operating the device safely. The instructions are binding for handling SAMSON devices. The images shown in these instructions are for illustration purposes only. The actual product may vary.

- For the safe and proper use of these instructions, read them carefully and keep them for later reference.
- If you have any questions about these instructions, contact SAMSON's After-sales Service (aftersaleservice@samsongroup.com).



The mounting and operating instructions for the devices are included in the scope of delivery. The latest documentation is available on our website at www.samsongroup.com > **Service & Support** > **Downloads** > **Documentation**.

Definition of signal words

DANGER

Hazardous situations which, if not avoided, will result in death or serious injury

WARNING

Hazardous situations which, if not avoided, could result in death or serious injury

NOTICE

Property damage message or malfunction

Note

Additional information

Tip

Recommended action

1	Safety instructions and measures	1-1
1.1	Notes on possible severe personal injury	1-4
1.2	Notes on possible personal injury	1-4
1.3	Notes on possible property damage	1-5
2	Markings on the device	2-1
2.1	Nameplate	2-1
2.2	Firmware versions	2-2
3	Design and principle of operation	3-1
3.1	Fail-safe action	3-1
3.2	Communication	3-1
3.3	Versions	3-2
3.3.1	Standard version	3-2
3.3.2	Version with three-key operation	3-2
3.4	Additional equipment	3-2
3.5	Technical data	3-5
3.6	Dimensions in mm	3-8
4	Shipment and on-site transport	4-1
4.1	Accepting the delivered goods	4-1
4.2	Removing the packaging from the actuator	4-1
4.3	Transporting the actuator	4-1
4.4	Lifting the actuator	4-1
4.5	Storing the actuator	4-2
5	Installation	5-1
5.1	Installation conditions	5-1
5.2	Preparation for installation	5-2
5.3	Mounting the actuator	5-2
5.4	Retrofitting limit contacts	5-3
5.5	Retrofitting electronic limit contacts	5-7
5.6	Retrofitting RS-485 module	5-7
5.7	Electrical connection	5-8
5.7.1	Connection (standard version)	5-8
5.7.2	Connection of version with three-key operation	5-14
6	Operation	6-1
6.1	Device overview and operating controls	6-1
6.1.1	Display	6-2
6.1.2	Rotary pushbutton	6-4
6.1.3	Keys on version with three-key operation	6-4

Contents

7	Start-up and configuration	7-1
7.1	Initializing the actuator.....	7-1
7.2	Configuring the actuator.....	7-2
7.2.1	Fast configuration level.....	7-3
7.3	Selecting the application.....	7-6
7.4	Adjusting the limit contacts.....	7-8
7.5	Setting up communication.....	7-10
7.5.1	Serial interface.....	7-10
7.5.2	Modbus RTU module.....	7-11
8	Setup	8-1
8.1	Automatic mode.....	8-1
8.1.1	Information level.....	8-1
8.1.2	Operating level.....	8-2
8.1.2.1	Selecting the operating mode.....	8-2
8.1.2.2	Determining the reading direction.....	8-2
8.1.2.3	Switching on the backlight.....	8-3
8.2	Manual mode.....	8-4
8.2.1	Mechanical override.....	8-4
8.2.2	MAN mode.....	8-6
8.3	Operation using memory pen.....	8-7
8.3.1	Memory and data logging function.....	8-7
8.3.2	Command function.....	8-8
8.4	Service mode.....	8-9
8.4.1	Zero calibration.....	8-10
8.4.2	Initializing the actuator.....	8-11
8.4.3	Restarting the actuator (reset).....	8-11
8.4.4	Loading the default settings.....	8-12
8.4.5	Testing the display.....	8-12
8.4.6	Measuring the transit time.....	8-13
9	Malfunctions	9-1
9.1	Troubleshooting.....	9-1
9.1.1	Error messages.....	9-1
9.1.2	Other malfunctions or errors.....	9-5
9.2	Emergency action.....	9-5
10	Servicing	10-1
11	Decommissioning	11-1
12	Removal	12-1
13	Repairs	13-1

13.1	Returning the actuator to SAMSON.....	13-1
14	Disposal.....	14-1
15	Certificates.....	15-1
16	Annex A (configuration instructions).....	16-1
16.1	Key number.....	16-1
16.2	Input signal.....	16-2
16.3	Direction of action.....	16-4
16.4	End position guiding.....	16-5
16.5	Position feedback signal.....	16-6
16.6	Binary input.....	16-6
16.7	Binary output.....	16-7
16.8	Electronic limit contacts.....	16-8
16.9	Restart.....	16-9
16.10	Blockage.....	16-10
16.11	Travel.....	16-11
16.12	Characteristic.....	16-12
16.13	Applications.....	16-14
16.14	Levels and parameters.....	16-15
16.14.1	Information level.....	16-15
16.14.2	Operating level.....	16-17
16.14.3	Service level.....	16-18
16.14.4	Communication level.....	16-20
16.14.5	Configuration level.....	16-21
16.15	Further codes on the display.....	16-27
16.16	Excerpt from Modbus data point list.....	16-27
17	Annex B.....	17-1
17.1	Parts for retrofitting and accessories.....	17-1
17.2	After-sales service.....	17-2

Contents

1 Safety instructions and measures

Intended use

The Type 3375 Electric Actuator is designed to operate a mounted globe valve used in industrial applications as well as in heating, ventilation and air-conditioning systems. The digital positioner ensures a predetermined assignment of the valve position to the input signal. The actuator is designed to operate under exactly defined conditions (e.g. thrust, travel). Therefore, operators must ensure that the actuator is only used in operating conditions that meet the specifications used for sizing the actuator at the ordering stage. In case operators intend to use the actuator in other applications or conditions than specified, contact SAMSON.

SAMSON does not assume any liability for damage resulting from the failure to use the device for its intended purpose or for damage caused by external forces or any other external factors.

➔ Refer to the technical data for limits and fields of application as well as possible uses (see 'Technical data').

Reasonably foreseeable misuse

The actuator is not suitable for the following applications:

- Use outside the limits defined during sizing and by the technical data

Furthermore, the following activities do not comply with the intended use:

- Use of non-original spare parts
- Performing service and repair work not described

Qualifications of operating personnel

The actuator must be mounted, started up, serviced and repaired by fully trained and qualified personnel only; the accepted industry codes and practices must be observed. According to these mounting and operating instructions, trained personnel refers to individuals who are able to judge the work they are assigned to and recognize possible hazards due to their specialized training, their knowledge and experience as well as their knowledge of the applicable standards.

Safety instructions and measures

Personal protective equipment

No personal protective equipment is required for the direct handling of the electric actuator. Work on the control valve may be necessary when mounting or removing the device.

- Observe the requirements for personal protective equipment specified in the valve documentation.
- Check with the plant operator for details on further protective equipment.

Revisions and other modifications

Revisions, conversions or other modifications of the product are not authorized by SAMSON. They are performed at the user's own risk and may lead to safety hazards, for example. Furthermore, the product may no longer meet the requirements for its intended use.

Safety features

The actuator has a thermal fuse which protects the asynchronous motor. The limit switches automatically switch off the motor in the end positions. In actuators with fail-safe action, the actuator stem moves to a defined end position upon supply voltage failure. The fail-safe action of SAMSON actuators is specified on the actuator nameplate.

Warning against residual hazards

To avoid personal injury or property damage, plant operators and operating personnel must prevent hazards that could be caused in the control valve by the process medium, the operating pressure, the signal pressure or by moving parts by taking appropriate precautions. Plant operators and operating personnel must observe all hazard statements, warning and caution notes in these mounting and operating instructions, especially for installation, start-up and service work.

Responsibilities of the operator

Operators are responsible for proper use and compliance with the safety regulations. Operators are obliged to provide these mounting and operating instructions to the operating personnel and to instruct them in proper operation. Furthermore, operators must ensure that operating personnel or third parties are not exposed to any danger.

Responsibilities of operating personnel

Operating personnel must read and understand these mounting and operating instructions as well as the specified hazard statements, warning and caution notes. Furthermore, the operating personnel must be familiar with the applicable health, safety and accident prevention regulations and comply with them.

Referenced standards, directives and regulations

The Type 3375 Electric Actuator fulfills the requirements of the Directives 2014/30/EU and 2014/35/EU. The declaration of conformity includes information about the applied conformity assessment procedure. This declaration of conformity is included in the annex of these instructions.

The Type 3375 Electric Actuator is designed for use in low voltage installations.

→ For wiring, maintenance and repair, observe the relevant safety regulations.

Referenced documentation

The following documents apply in addition to these mounting and operating instructions:

- Mounting and operating instructions of the valve on which the electric actuator is mounted, e.g. for SAMSON valves:
 - ▶ EB 5861 for Type 3260 Three-way Valve
 - ▶ EB 5868-1 for Type 3214 Globe Valve balanced by a diaphragm
 - ▶ EB 8012 for Type 3241 Globe Valve, ANSI and JIS version
 - ▶ EB 8015 for Type 3241 Globe Valve, DIN version
 - ▶ EB 8026 for Type 3244 Three-way Valve
 - ▶ EB 8051 for Type 3251 Globe Valve, DIN version
 - ▶ EB 8052 for Type 3251 Globe Valve, ANSI version

1.1 Notes on possible severe personal injury

DANGER

Risk of fatal injury due to electric shock.

- Before connecting wiring, performing any work on the device or opening the device, disconnect the supply voltage and protect it against unintentional reconnection.
- Only use power interruption devices that can be protected against unintentional reconnection of the power supply.
- Do not remove any covers to perform adjustment work on live parts.

Risk of bursting in pressure equipment.

Valves and pipelines are pressure equipment. Improper opening can lead to valve components bursting.

- Before starting any work on the control valve, depressurize all plant sections affected as well as the valve.
- Drain the process medium from all the plant sections affected and from the valve.
- Wear recommended personal protective equipment (see associated valve documentation).

1.2 Notes on possible personal injury

WARNING

Crush hazard arising from moving parts.

The electric actuator contains moving parts (actuator and plug stems), which can injure hands or fingers if inserted into the actuator.

- Do not insert hands or finger into the yoke while the valve is in operation.
- Disconnect the supply voltage and protect it against unintentional reconnection before performing any work on the control valve.
- Do not impede the movement of the actuator or plug stem by inserting objects into their path.

⚠ WARNING

Risk of personal injury through incorrect operation, use or installation as a result of information on the actuator being illegible.

Over time, markings, labels and nameplates on the actuator may become covered with dirt or become illegible in some other way. As a result, hazards may go unnoticed and the necessary instructions not followed. There is a risk of personal injury.

- Keep all relevant markings and inscriptions on the device in a constantly legible state.
- Immediately renew damaged, missing or incorrect nameplates or labels.

1.3 Notes on possible property damage

ⓘ NOTICE

Risk of damage to the electric actuator due to the supply voltage exceeding the permissible tolerances.

The Type 3375 Electric Actuator is designed for use according to regulations for low-voltage installations.

- Observe the permissible tolerances of the supply voltage.

Risk of actuator damage due to excessively high tightening torques.

Observe the specified torques when tightening the mounting parts of Type 3375 Electric Actuators. Excessive tightening torques lead to parts wearing out more quickly.

- Observe the specified tightening torques.

Risk of damage to the electric actuator due to incorrect operation of the manual override.

The actuator stem of the electric actuator without fail-safe action can be adjusted manually.

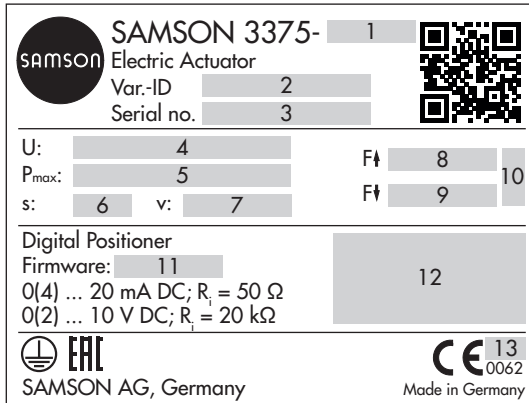
- Do not operate the manual override while the actuator is in operation or while the voltage supply is still connected.

Risk of actuator damage due to incorrect wiring of the binary inputs.

- Always wire the binary inputs as floating contacts.

2 Markings on the device

2.1 Nameplate



- 1 Type
- 2 Configuration ID
- 3 Serial number
- 4 Supply voltage; power line frequency
- 5 Power consumption
- 6 Rated travel
- 7 Stroking speed
- 8 Thrust (actuator stem retracts)
- 9 Thrust (stem extends)

- 12 Limit contacts



Mechanical limit contacts



Electronic limit contacts

- 13 Year

- 10 Fail-safe action



Extends



Retracts

- 11 Firmware version

2.2 Firmware versions

Firmware revisions	
Old	New
3.10	3.11
	(internal revisions)
3.11	3.12
	Baud rate 38400 is no longer available for Modbus.
	Communication parameters can only be changed after the key number has been entered.
	Special version with three-key operation is available.
	The actuator version with three-key operation allows the set point to be changed and displayed on the start screen in "PID controller" and "Temperature closed-loop control upon input signal failure" applications. The key number does not need to be entered beforehand in this case.
Extended temperature measurement: In the "PID controller" application, temperatures can be additionally measured using a Pt 1000 sensor at input 1 and input 2. The Code c85 (unit) must be set to "°C" and Code c01 (source) to "Pt 1000 input". The measuring range has a fixed range (-50 °C to +150 °C). The measured values can only be read over two Modbus holding registers and not processed any further in the actuator.	

3 Design and principle of operation

The Type 3375 Electric Actuator is used in industrial plants as well as in heating, ventilation and air-conditioning systems.

This linear actuator is particularly suitable, depending on whether the version is **with or without fail-safe action**, for attachment to SAMSON Series 240 and 250 Valves as well as to Type 3260 Valve (DN 200, 250 and 300) and Type 3214 Valve (DN 300 and 400).

The actuator can be used for various types of control (see the 'Start-up and configuration' section).

Principle of operation

The electric actuator consists of a reversible asynchronous motor and a maintenance-free planetary gear with ball screw drive. The actuator is switched off by torque-dependent limit contacts. Additionally, the asynchronous motor is protected by a thermal fuse.

3.1 Fail-safe action

The actuator versions with fail-safe action contain a spring mechanism and an electromagnet. The actuator is moved by the force of the spring to the fail-safe position when the electromagnet (terminals L and N) is de-energized. The direction of action depends on the actuator version and cannot be reversed.

3.2 Communication

Serial interface

The actuator is fitted with an RS-232 serial interface as standard. This allows communication with TROVIS-VIEW using SSP protocol.

i Note

The actuator can also be fitted with an optional RS-485 module (see the 'Installation' section).

Configuration

The actuator can be configured with the TROVIS-VIEW software. In this case, the serial interface on the actuator is used to connect the actuator to the computer.

The TROVIS-VIEW software enables the user to easily configure the positioner as well as view process parameters online.

i Note

TROVIS-VIEW can be downloaded free of charge from our website at

▶ www.samsongroup.com > Service & Support > Downloads > TROVIS-VIEW. Further information on TROVIS-VIEW (e.g. system requirements) is available on our website and in the Data Sheet ▶ T 6661 as well as the Operating Instructions ▶ EB 6661.

➔ See the 'Start-up and configuration' section.

3.3 Versions

3.3.1 Standard version

The operating controls are located underneath the housing cover (see Fig. 3-2).

3.3.2 Version with three-key operation

In the special version of the actuator with three-key operation, the actuator is not operated using the rotary pushbutton. Instead, three keys on the cover are used for operation (see Fig. 3-1).

This actuator version can be operated without having to remove the housing cover.

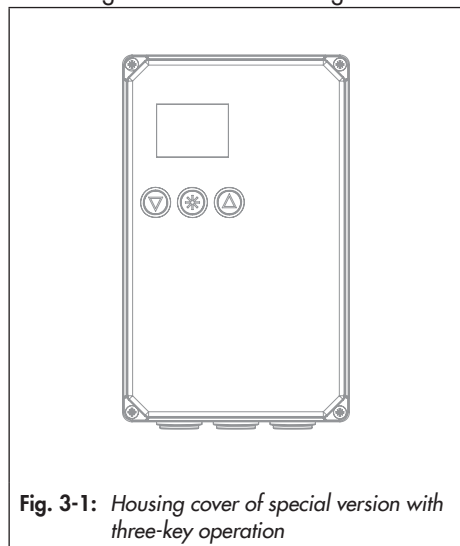


Fig. 3-1: *Housing cover of special version with three-key operation*

3.4 Additional equipment

Mechanical limit contacts

The two mechanical limit contacts consist of two changeover switches. Their switching positions are changed independently from one another by continuously adjustable cam disks. The floating contacts can be used as either make or break contacts to influence the tasks of control equipment.

The installation and adjustment of the mechanical limit contacts is described in the 'Installation' section.

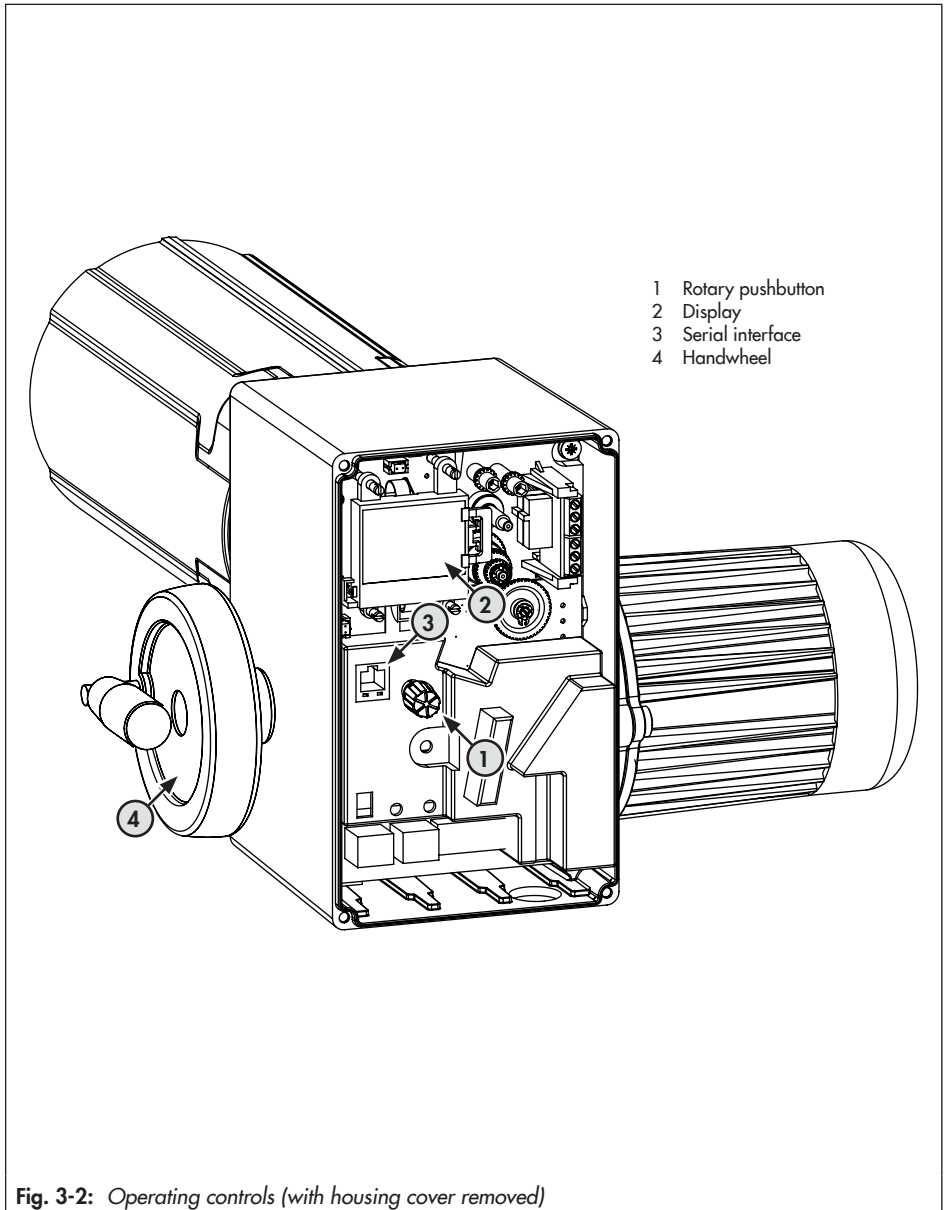


Fig. 3-2: Operating controls (with housing cover removed)

Design and principle of operation

Electronic limit contacts

The two electronic limit contacts consist of relays with changeover contacts. The floating contacts can be used as either make or break contacts to influence the tasks of control equipment.

In contrast to the mechanical limit contacts, the electronic limit contacts no longer function after a supply voltage failure. The relays are de-energized and the contacts change to the idle state.

The installation of the electronic limit contacts is described in the 'Installation' section. Their adjustment is described in the 'Start-up and configuration' section.

The electronic limit contact can be triggered by the actuator stem position exceeding or falling below an adjustable switching point.

- **Triggered when the position exceeds the switching point:** The limit contact is activated when the actuator stem position moves beyond the switching point. The limit contact is deactivated when the actuator stem moves below the switching point plus 'Hysteresis'.
- **Triggered when the position moves below the switching point:** The limit contact is activated when the actuator stem position moves below the 'Switching point'. The limit contact is deactivated when the actuator stem position moves beyond the switching point plus 'Hysteresis'.

i Note

An activated limit contact remains permanently active if the switching point is smaller or larger than the hysteresis. This limit contact can only be deactivated by a restart (see the 'Operation' section) or by resetting to 'NONE' (c24, c27).

RS-485 module

The RS-485 module allows the actuator to be connected to a control station. Various communications protocol (SSP or Modbus RTU slave) are used for various functions. The RS-485 module is required for Modbus RTU communication.


➔ Excerpt from Modbus list: see Annex A.

3.5 Technical data

Table 3-1: *Technical data · Actuator*

Type 3375	-10	-11	-20	-21	-22	-30	-31
Fail-safe action	Without		Actuator stem extends			Actuator stem retracts	
Attachment (form-fit)	M30x1.5	M60x1.5	M30x1.5	M60x1.5	M30x1.5	M30x1.5	M60x1.5
Rated travel mm	30	60	30	60	30	30	60
Limited travel range	Between 10 and 100 % of the rated travel						
Handwheel	Handwheel	•	•	-	-	-	-
	Electric	•	•	•	•	•	•
Electrical connection							
Supply voltage	230 V, 50 to 60 Hz						
Duty type	S3 - 50 % ED (1200 c/h) according to IEC 60034-1						
Power consumption VA	180	180	185	185	185	185	185
Transit time in s for rated travel							
50 Hz	50	100	50	100	50	50	100
60 Hz	42	84	42	84	42	42	84
In the event of fail-safe action (approx.)	-	-	35	80	40	40	90
Stroking speed in mm/s							
50 Hz	0.6	0.6	0.6	0.6	0.6	0.6	0.6
60 Hz	0.7	0.7	0.7	0.7	0.7	0.7	0.7
In the event of fail-safe action (approx.)	-	-	0.86	0.75	0.75	0.75	0.67
Thrust in kN							
Extends	12.5	12.5	7.5	5	4	4	4
Retracts	12.5	12.5	1	1	4	4	2.5
Weight [kg]							
Approx.	11.7	14.5	19.5	22.5	18	18	21

Design and principle of operation

Type 3375		-10	-11	-20	-21	-22	-30	-31
Device safety								
Degree of protection		IP 65 according to EN 60529, suspended mounting not permitted according to EN 60664						
Class of protection		I according to EN 61140						
Device safety		According to EN 61010-1						
Noise immunity		According to EN 61000-6-2 and EN 61326-1						
Noise emission		According to EN 61000-6-3 and EN 61326-1						
Conformity								
Additional electrical equipment								
Limit contacts	Mechanical	Two adjustable limit contacts with changeover switches; 230 V AC/1 A · Without contact protection						
	Electronic	Two adjustable limit contacts with relay and changeover switches; 230 V AC/1 A · Without contact protection						
RS-485 module		Module for Modbus RTU communication						
Materials								
Housing	Bottom section	Spheroidal graphite iron						
	Middle section	Cast aluminum alloy						
	Motor housing	Cast aluminum alloy						
	Fan guard	Plastic						
Cover		Glass-fiber-reinforced plastic						
Actuator stem		Stainless steel						
Other information								
Motor switch-off		By torque-dependent limit switches						
Permissible temperature ranges ²⁾	Ambient	5 to 60 °C						
	Storage	-20 to +70 °C						
Humidity		5 to 95 % relative air humidity, no dew formation						

¹⁾ Manual override is not possible in actuators with fail-safe action upon fail-safe action.

²⁾ The permissible medium temperature depends on the valve on which the electric actuator is mounted. The limits in the valve documentation apply.

Table 3-2: Technical data · Digital positioner

Digital positioner			
Input signal	Current input	0/4 to 20 mA, adjustable · $R_i = 50 \Omega$	
	Voltage input	0/2 to 10 V, adjustable · $R_i = 20 \text{ k}\Omega$	
	Pt 1000 input ¹⁾	Measuring range: -50 to +150 °C, 300 μA	
	Binary input ²⁾	By jumpering the terminals, not galvanically isolated	
Position feedback	Current	0/4 to 20 mA, adjustable · Error message 24 mA	
		Resolution	1000 steps or 0.02 mA
	Voltage	Load	Max. 200 Ω
			0/2 to 10 V, adjustable · Error message 12 V
		Resolution	1000 steps or 0.01 V
		Load	Minimum 5 $\text{k}\Omega$
Binary input		Open-circuit voltage: 10 V; short-circuit current: 5 mA By jumpering the terminals, not galvanically isolated	
Binary output		Floating, max. 230 V AC/1 A	
Applications	Positioner	The travel follows the input signal	
	PID controller	Fixed set point control	
	Two-step mode	Two-step behavior, control over binary input	
	Three-step mode	Three-step behavior, control over binary input	
	Temperature closed-loop control upon input signal failure	The integrated PID controller uses a fixed set point for closed-loop control when the input signal is missing.	
Display		Icons for functions, codes and text field with backlight	
Rotary pushbutton		Operating control for on-site operation to select and confirm codes and values	
Interface	Standard	RS-232 · For point-to-point connection to communication participants or for memory pen · Permanently installed · Connection: RJ-12 connector socket	

¹⁾ For PID Controller (PID) and Temperature closed-loop control upon input signal failure (POSF) applications only

²⁾ For two-step mode (2STP) and three-step mode (3STP) applications

3.6 Dimensions in mm

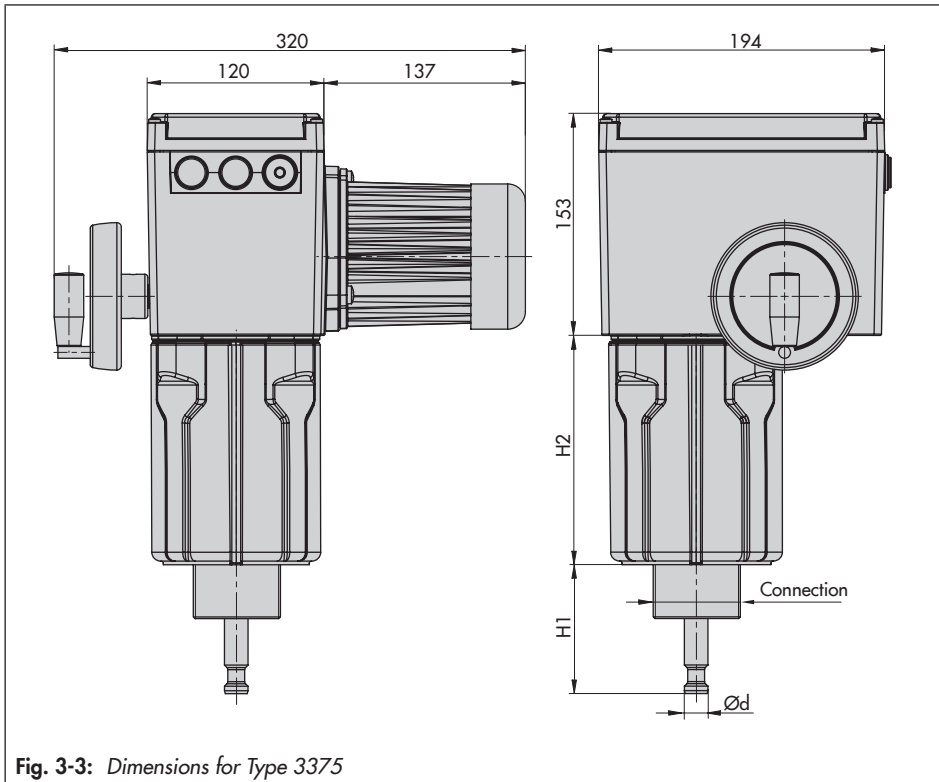


Table 3-3: Dimensions for Type 3375 Actuator

Type 3375		-10	-11	-20	-21	-22	-30	-31
Connection		M30x1.5	M60x1.5	M30x1.5	M60x1.5	M30x1.5	M30x1.5	M60x1.5
Rated travel	(mm)	30	60	30	60	30	30	60
Actuator stem	Ø d in mm	16	22	16	22	16	16	22
H1 stem retracted	(mm)	60	105	60	105	60	60	105
H1 stem extended	(mm)	90	165	90	165	90	90	165
H2	(mm)	124	174	229	279	229	229	279

4 Shipment and on-site transport

The work described in this section is only to be performed by personnel appropriately qualified to carry out such tasks.

4.1 Accepting the delivered goods

After receiving the shipment, proceed as follows:

1. Compare the shipment received with the delivery note.
2. Check the shipment for transportation damage. Report any damage to SAMSON and the forwarding agent (refer to delivery note).

4.2 Removing the packaging from the actuator

i Note

Do not remove the packaging until immediately before mounting and start-up.

1. Remove the packaging from the electric actuator.
2. Check scope of delivery (see Fig. 4-1).
3. Dispose of the packaging in accordance with the valid regulations.

1x	Type 3375-xx Electric Actuator
1x	Document IP 8332-2 (Important Product Information)
for Types 3375-10, -20, -22, -30:	
1x	Accessory 0900-2679, consisting of
2x	Stem connector for Ø 16 mm stem
2x	M6 screw
1x	M30x1.5 ring nut
for Types 3375-11, -21, -31:	
1x	Accessory 1400-9565, consisting of
2x	Stem connector for Ø 22 mm stem
2x	M12 screw
1x	M60x1.5 ring nut

Fig. 4-1: Scope of delivery

4.3 Transporting the actuator

- Protect the actuator against external influences (e.g. impact).
- Protect the actuator against moisture and dirt.
- Observe the permissible transportation temperature of -20 to $+70$ °C.

4.4 Lifting the actuator

- Use suitable equipment to lift the actuator.

4.5 Storing the actuator

NOTICE

Risk of electric actuator damage due to improper storage.

- *Observe the storage instructions.*
 - *Avoid long storage times.*
 - *Contact SAMSON in case of different storage conditions or longer storage times.*
-

Note

We recommend regularly checking the electric actuator and the prevailing storage conditions during long storage periods.

Storage instructions

- Protect the electric actuator against external influences (e.g. impact).
- Protect the electric actuator against moisture and dirt.
- Make sure that the ambient air is free of acids or other corrosive media.
- Observe the permissible storage temperature from -20 to $+70$ °C.
- Do not place any objects on the electric actuator.

5 Installation

The work described in this section is only to be performed by personnel appropriately qualified to carry out such tasks.

5.1 Installation conditions

Work position

If not described otherwise in the valve documentation, the work position for the control valve is the front view looking onto the operating controls.

Mounting orientation

The control valve can be installed in the pipeline in any desired position. However, a suspended mounting position of the actuator is not permissible (see Fig. 5-1).

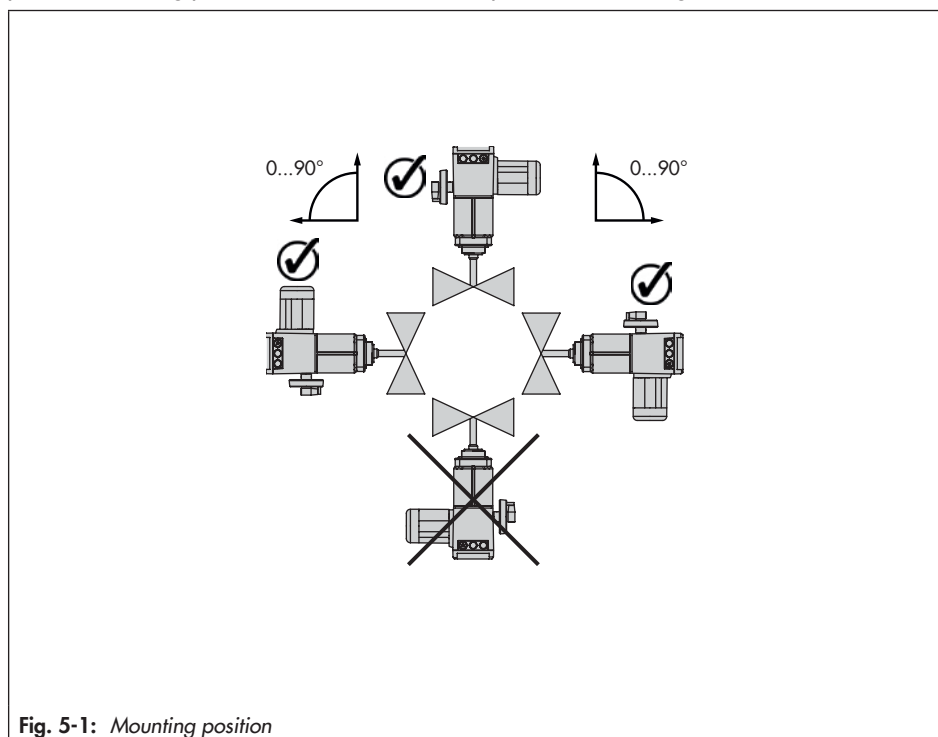


Fig. 5-1: Mounting position

5.2 Preparation for installation

Before installation, make sure the following conditions are met:

- The actuator is not damaged.

Proceed as follows:

Lay out the necessary material and tools to have them ready during mounting.

5.3 Mounting the actuator

1. Push the plug stem down.
2. Turn the stem connector nut (7) until the dimension x from the top of the yoke to the middle of the stem connector nut (7) is achieved:
With M30: $x = 90$ mm
With M60: $x = 165$ mm
Lock this position with the lock nut (8).
3. **Actuator without fail-safe action:**
Retract the actuator stem using the manual override (see the 'Operation' section).
Actuator with fail-safe action:
Retract the actuator stem electrically in the MAN mode (see the 'Operation' section).
4. Place actuator onto the valve bonnet (2) and secure using the ring nut (6).

Tightening torque (M30)	150 Nm
Tightening torque (M60)	250 Nm

5. When the stem connector nut (7) rests on the actuator stem, attach both stem connector clamps (4) and fasten with screws.

6. Move actuator stem (3) to the end position (valve closed) using the manual override or electrically.
7. Align travel indicator scale (9) with the middle of the stem connector (4) and screw tight.

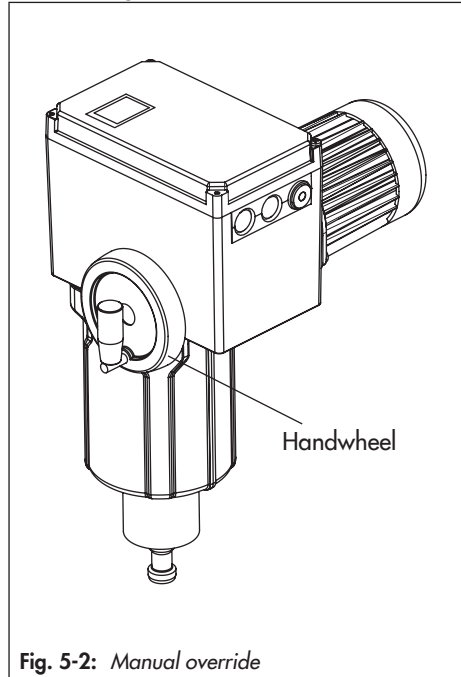
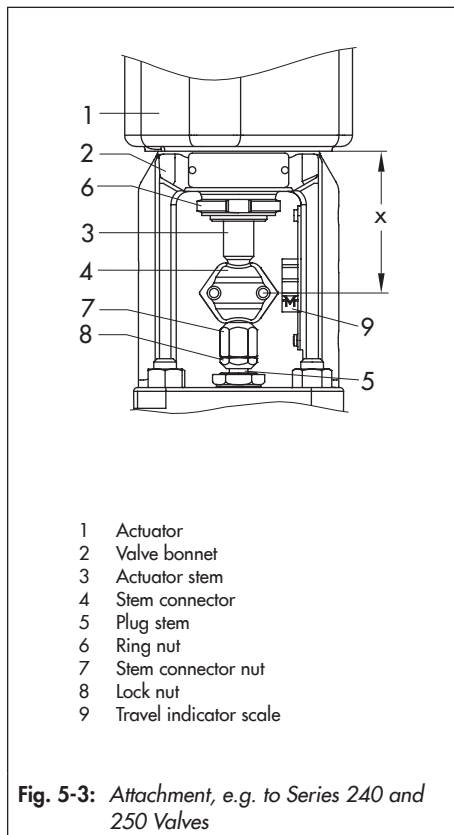


Fig. 5-2: Manual override

i Note

For actuators with "actuator stem extends" fail-safe action (see nameplate), the supply voltage must be applied to allow the actuator stem be retracted. To apply the supply voltage, proceed as described in section 5.7.



To install the mechanical limit contacts, the following retrofit kit is required:

- Mechanical limit contacts:
Order no. **1402-0898** (see Annex B)

Tip

We recommend applying a small amount of lubricant (e.g. Vaseline) to the spindles on the gear faces and to the sides of the cogs.

Note

- The listed retrofit kits also contain parts needed to retrofit other SAMSON actuators. Not all the parts in the kits are required for the Type 3375 Actuator.
- To undo the screws on the housing cover, use a POZIDRIV® PZ2 screwdriver to get enough hold on the screw heads.

5.4 Retrofitting limit contacts

DANGER

Risk of fatal injury due to electric shock.

- Before installing electrical accessories, switch off the supply voltage and disconnect the signal line.

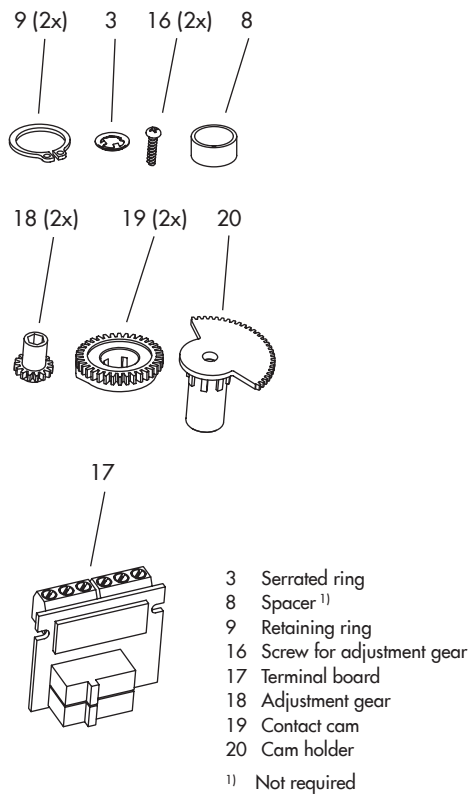


Fig. 5-4: Limit contacts (accessories), order no. 1402-0898

i Note

The contact cams (19) are ready-mounted to the cam holder (20) and the retaining rings (9) to form the contact cam unit (21, see Fig. 5-5).

1. Unscrew screws on housing cover and take the cover off the actuator.

NOTICE

Risk of damage to the connecting cable due to incorrect handling.

Actuator version with three-key operation: make sure that the connecting cable between the housing cover and actuator board is not damaged when removing the housing cover.

➔ *Fasten the housing cover to the housing before performing work on the actuator (see section 5.7).*

2. Move the actuator stem to the end position depending on the fail-safe action "actuator stem extends" or "actuator stem retracts" (see the 'Design and principle of operation' section).
3. Slide adjustment gears (18) onto their spindles and fasten with one screw each. Check whether the adjustment gears can be turned easily. If not, slightly loosen its screw again.
4. Align the contact cam unit (21): To do this, turn both contact cams (19) on the cam holder (20) as illustrated in Fig. 5-6 corresponding with the position of the actuator stem.
5. Slide the contact cam unit (21) onto the spindle corresponding with the position of the actuator stem as illustrated in Fig. 5-7. Make sure that the outermost cog of the contact cam unit engages in the gearwheel of the intermediate gear (1). In addition, the adjustment gears (18) must engage properly in the corresponding gears of the contact cam unit (21).
6. Secure the contact cam unit (21) and intermediate gear (1) with the serrated ring (3); push down the serrated ring as far as it will go.
7. Position the terminal board (17) at the base of the support at a 45° angle (approx.) with the switches pointing towards the gears. Swivel the upper end of the terminal board towards the gears until the board is in a vertical position and properly engaged in the support.
8. Adjust limit contacts as described in the 'Start-up and configuration' section.
9. Replace cover. Briefly turn the fastening screws counterclockwise with a screwdriver to center them. Then fasten down the cover by tightening the screws.

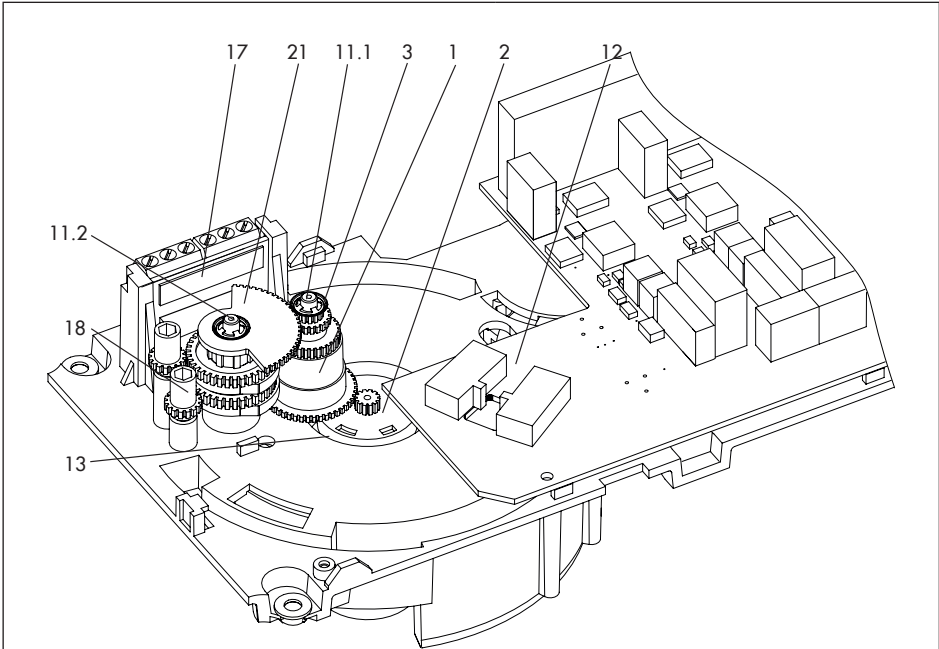


Fig. 5-5: Retrofitting of limit contacts without resistance transmitters

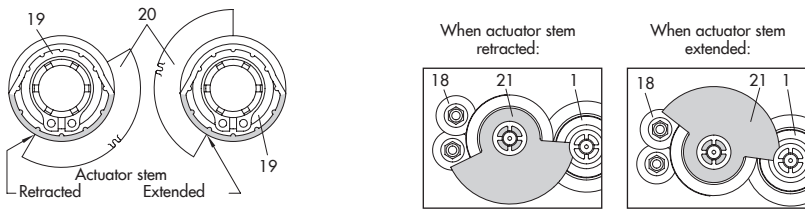


Fig. 5-6: Alignment of contact cam to the cam holder Fig. 5-7: Alignment of the contact cam unit

1	Intermediate gear	13	Bearing sleeve
2	Spindle gear	17	Terminal board
3	Serrated ring	18	Adjustment gear
11.1	Spindle 1	19	Contact cam
11.2	Spindle 2	20	Cam holder
12	Actuator board	21	Contact cam unit

5.5 Retrofitting electronic limit contacts

⚠ DANGER

Risk of fatal injury due to electric shock.

→ Before installing electrical accessories, switch off the supply voltage and disconnect the signal line.

To install the electronic limit contacts, the following retrofit kit is required:

- Mechanical limit contacts:
Order no. **1402-0591** (see Annex B)

i Note

To undo the screws on the housing cover, use a POZIDRIV® PZ2 screwdriver to get enough hold on the screw heads.

1. Undo screws on housing cover and take the cover off the actuator.

ⓘ NOTICE

Risk of damage to the connecting cable due to incorrect handling.

Actuator version with three-key operation: make sure that the connecting cable between the housing cover and actuator board is not damaged when removing the housing cover.

→ Fasten the housing cover to the housing before performing work on the actuator (see Fig. 5-15).

2. Connect the connector on the connecting cable to the plug-in location intended for it on the board.

3. Position the terminal board (17, see Fig. 5-5) at the base of the support at a 45° angle (approx.) with the relay pointing towards the edge of the intermediate board. Swivel the upper end of the terminal board until the board is properly engaged.
4. Adjust limit contacts as described in the 'Start-up and configuration' section.
5. Replace cover. Briefly turn the fastening screws counterclockwise with a screwdriver to center them. Then fasten down the cover by tightening the screws.

5.6 Retrofitting RS-485 module

To install the RS-485 module for Modbus RTU communication, the following retrofit kit is required:

- RS-485 module:
Order no. **1402-1522** (see Annex B)

⚠ DANGER

Risk of fatal injury due to electric shock.

→ Before installing electrical accessories, switch off the supply voltage and disconnect the signal line.

1. Undo screws on housing cover and take the cover off the actuator.
2. Switch off the supply voltage.
3. Insert the four spacers into the holes intended for them in the actuator board.
4. Place the RS-485 module with the connector side facing downward onto the spacers.

- The pins must be guided from the top into the socket on the board.
- 5. Perform the wiring as described in section 5.7.
- 6. Set up Modbus communication (see the 'Start-up and configuration' section).

5.7 Electrical connection

⚠ DANGER

Risk of fatal injury due to electric shock.

- Upon installation of the electric cables, you are required to observe the regulations concerning low-voltage installations according to DIN VDE 0100 as well as the regulations of your local power supplier.
- Use a suitable voltage supply which guarantees that no dangerous voltages reach the device in normal operation or in the event of a fault in the system or any other system parts.
- Only perform the electrical connection after switching off the supply voltage. Make sure the supply voltage cannot be switched on unintentionally.

ⓘ NOTICE

Risk of actuator damage due to incorrect wiring of the binary inputs.

- Always wire the binary inputs as floating contacts.

5.7.1 Connection (standard version)

- Connect the wiring as shown in Fig. 5-8 and depending on the application being used (see Fig. 5-9 to Fig. 5-14).
- Guide the cables to the spring-cage terminals from the top (observe Table 5-1).
- Connect binary signals over floating contacts.

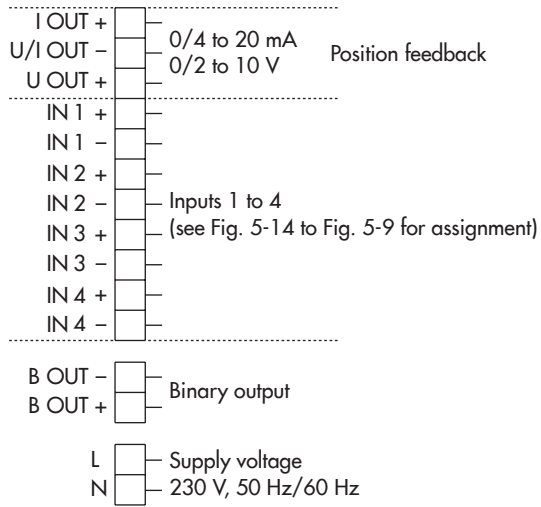
ⓘ Note

After connecting the supply voltage on starting up the actuator for the first time, the start screen and the error reading **E00 RUNT** (no initialization performed) appear in alternating sequence (see the 'Start-up and configuration' section).

Permissible cross-sections**Table 5-1:** *Cables and stranded wires that can be used*

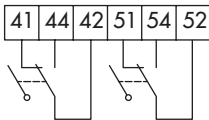
Cable	Cross section
Single-wire H05(07) V-U ¹⁾	0.2 to 1.5 mm ²
Fine-wire H05(07) V-K ¹⁾	0.2 to 1.5 mm ²
With wire ferrule acc. to DIN 46228-1	0.25 to 1.5 mm ²
With wire ferrule and sleeve acc. to DIN 46228-4	0.25 to 0.75 mm ²

¹⁾ Length of insulation to be stripped off wire ends = 8 mm

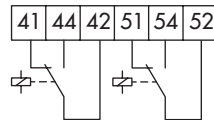


Options:

Mechanical limit contacts



Electronic limit contacts



RS-485 interface



RS-485 interface with external bus termination

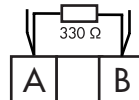


Fig. 5-8: Electrical connection

NOTICE

Risk of actuator damage due to incorrect wiring of the binary inputs.

→ Always wire the binary inputs as floating contacts.

Note

The function of the inputs depend on how the actuator is configured. Inputs that have not been configured do not have any effect.

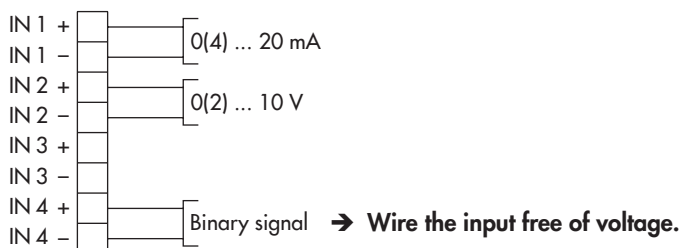
Application: Positioner (POSI)

Fig. 5-9: Terminal assignment for 'Positioner' application

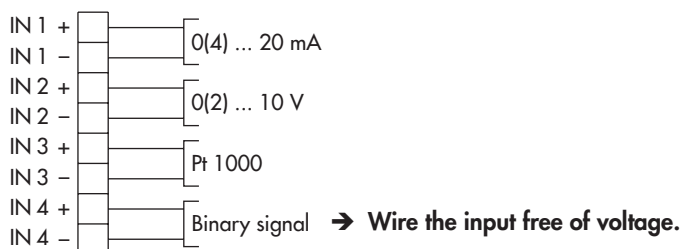
Application: PID controller (PID)

Fig. 5-10: Terminal assignment for 'PID controller' application

Application: PID controller (PID), temperature control

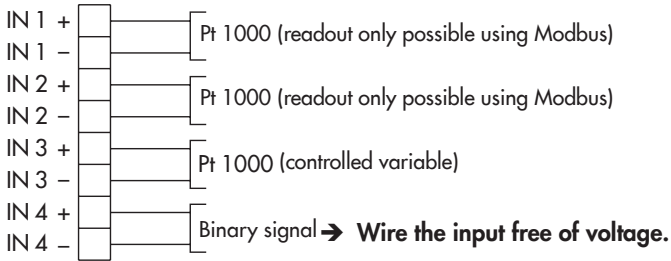


Fig. 5-11: Terminal assignment for 'PID controller' application · Temperature control

Application: Two-step mode (2STP)

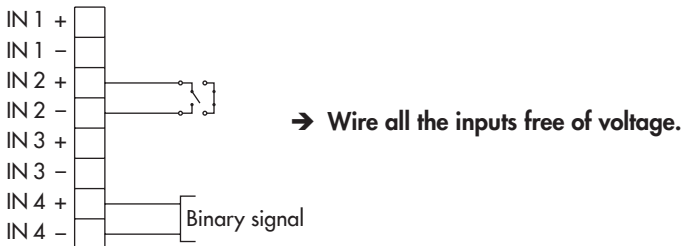
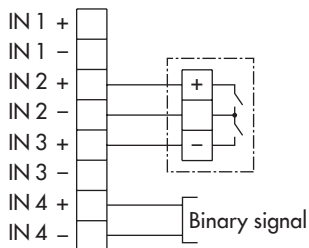


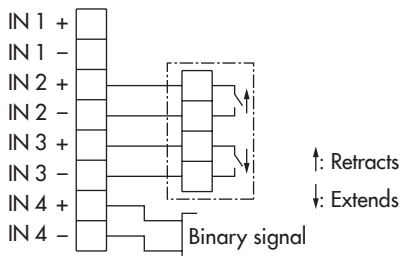
Fig. 5-12: Terminal assignment for 'Two-step mode' application

Application: Three-step mode (3STP)

Three-wire connection:



Four-wire connection:



→ Wire all the inputs free of voltage.

Fig. 5-13: Terminal assignment for 'Three-step mode' application

Application: Temperature closed-loop control upon input signal failure (POSF)

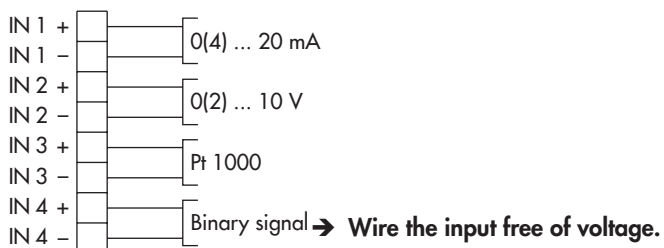
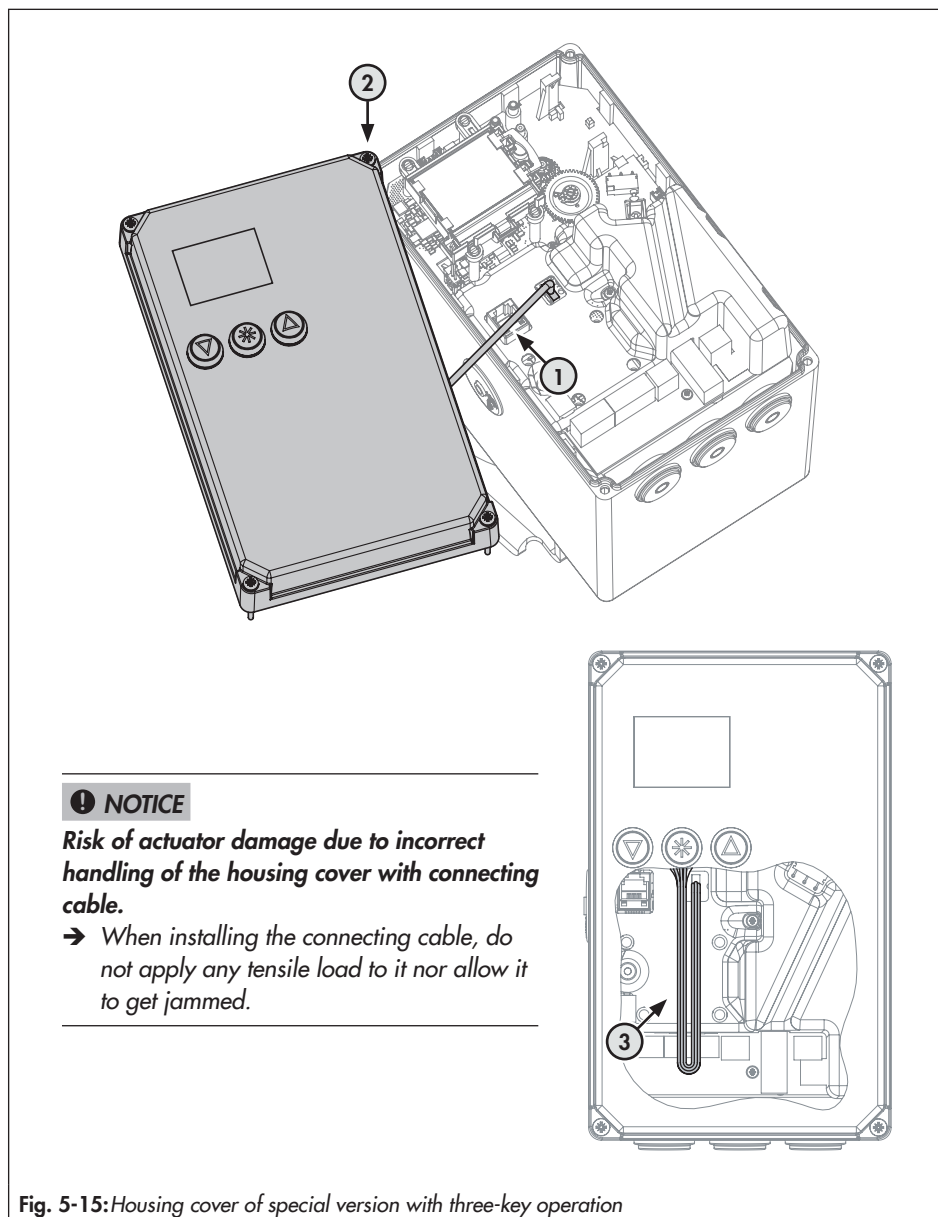


Fig. 5-14: Terminal assignment for 'Temperature closed-loop control upon input signal failure' application

5.7.2 Connection of version with three-key operation

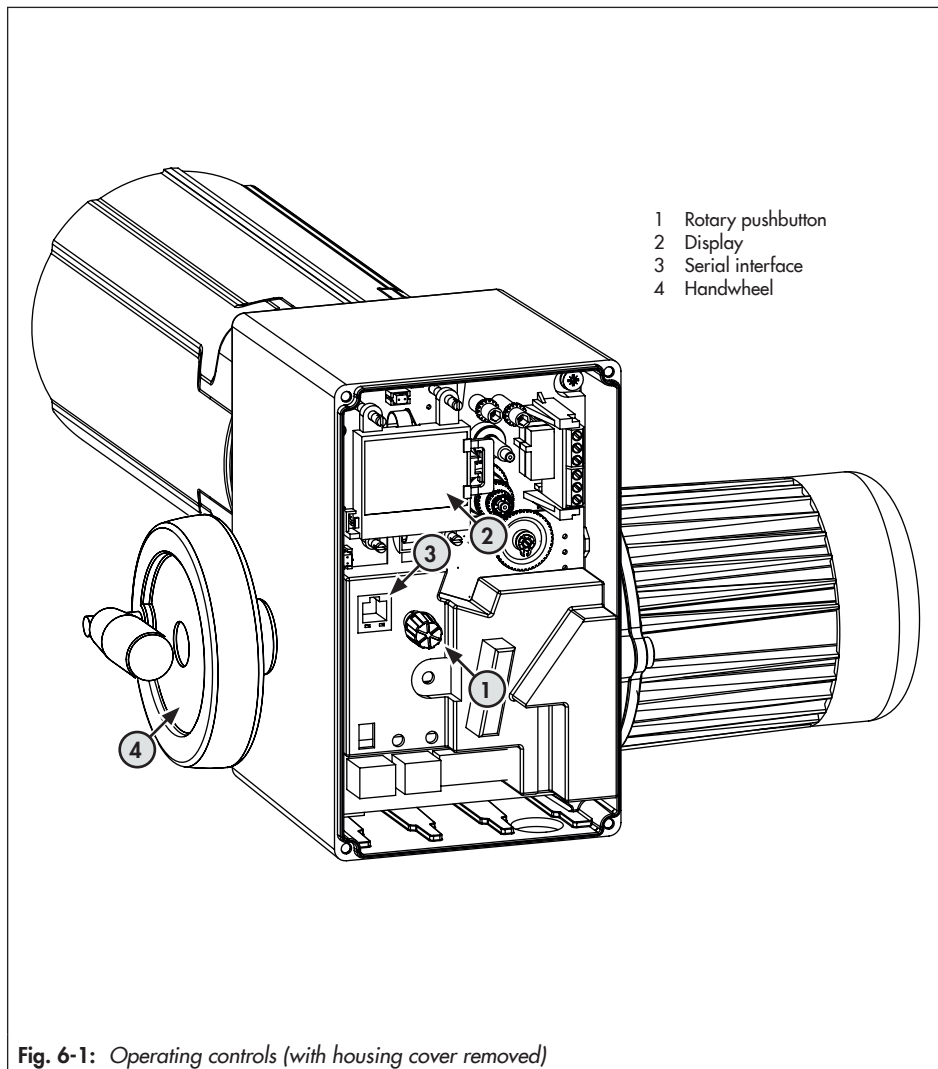
Perform electrical connection for the special version of Type 3375 with three-key operation as follows:

- ➔ See Fig. 5-15.
- 1. Unthread the four fastening screws of the housing cover. Lift off the housing cover.
- ➔ Make sure the connecting cable (1) of the housing cover is not damaged by tensile load.
- 2. Move the housing cover to the position as shown in Fig. 5-15:
- 3. Place on cover. Briefly turn the screw (2, see Fig. 5-15) counterclockwise to center it. Tighten it slightly.
- ➔ Make sure that the screw is not screwed all the way into the thread. Otherwise, the cover seal may become damaged.
- 4. Connect the wiring as shown in Fig. 5-8.
- 5. Loosen the screw (2, see Fig. 5-15), while holding the housing cover to ensure the connecting cable (1, see Fig. 5-15) of the housing cover does not get damaged by tensile load.
- 6. Place the housing cover on the housing and route the connecting cable in the housing as shown in Fig. 5-15.
- ➔ Make sure the connecting cable of the housing cover do not get jammed.
- 7. Briefly turn the fastening screws counterclockwise to center them. Then fasten down the cover by tightening the screws.



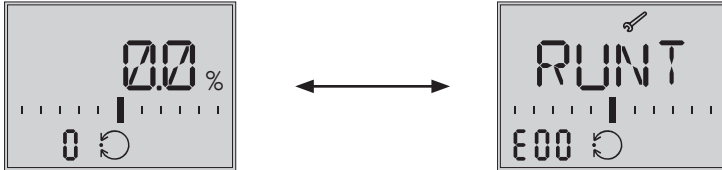
6 Operation

6.1 Device overview and operating controls



6.1.1 Display

After switching on the supply voltage, the current firmware is displayed for two seconds. Afterwards, the start screen appears.

















On starting up the actuator for the first time, the start screen and the error reading **E00** (no initialization performed) appear in alternating sequence.

Fig. 6-2: Start screen after starting up the actuator for the first time

Start screen

The start screen depends on the selected application (see the 'Start-up and configuration' section). On starting up the actuator for the first time and after loading default settings, the positioner application (POSI, see Fig. 6-2) is automatically selected.

Table 6-1: *Display icons*

<p>Operating modes</p>	 Automatic mode  Manual mode
<p>Bar graph The bars indicate the set point deviation that depends on the sign (+/-) and the value.</p>	 One bar element appears per 1 % set point deviation. <p>Example:</p>  <p>Bar graph indicates a +3 % set point deviation. A maximum of five bar elements can appear on each side. Five bar elements indicate a set point deviation $\geq 5\%$.</p>
<p>Status messages These icons indicate that an error has occurred.</p>	 Failure  Maintenance demanded
<p>Binary input/output active Code in bottom left-hand corner of the display</p>	 Code 0 on the display, binary input active  Code 0 on the display, binary output active  Code 0 on the display, binary input/output active
<p>Enable configuration</p>	 Indicates that the parameters in the configuration and service levels have been enabled for configuration.
<p>Limit contacts</p>	 Display reading 1  Display reading 2 <p>Indicates that the actuator stem position has fallen below or exceeded the switching point of the electronic limit contact.</p>
<p>Default setting</p>	 When the scale of the bar graph is not visible and only one bar element either side of the center is visible, this means the indicated parameter is the same as the default setting.
<p>mA unit</p>	 The icon indicates the mA unit in conjunction with a reading.


Operation

6.1.2 Rotary pushbutton

The operating controls are located underneath the housing cover (see Fig. 6-1).

The settings are changed using the rotary pushbutton.

Turn : select/change codes and values

Press : confirm setting/change

NOTICE


Changed parameters are immediately effective!


The process is directly affected by these changes.


➔ *First check any changes made to parameters before confirming them by pressing the rotary pushbutton.*

6.1.3 Keys on version with three-key operation

In the special version with three-key operation, the actuator is operated using three keys on the cover:




 Select/change codes and values (increase value)

 Confirm setting/change

 Select/change codes and values (reduce value)

Note

The operation and setting of the Type 3375 Actuator is described in these Mounting and Operating Instructions based on the version with rotary pushbutton.

Pressing keys  and  corresponds to turning the rotary pushbutton and the key  corresponds to pressing the rotary pushbutton of the standard actuator version.

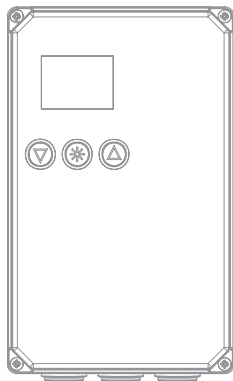


Fig. 6-3: *Housing cover of special version with three-key operation*

7 Start-up and configuration

The work described in this section is only to be performed by personnel appropriately qualified to carry out such tasks.

7.1 Initializing the actuator

⚠ WARNING

Risk of injury due to the actuator stem extending or retracting.

→ Do not touch or block the actuator stem.

ⓘ NOTICE

The process is disturbed by the movement of the actuator stem.

→ Do not perform the initialization while the process is running. First isolate the plant by closing the shut-off valves.

The initialization is performed in Code 5. During initialization, the actuator stem moves from its current position to the 100 % end position. Starting from the 100 % end position, the actuator stem moves to the 0 % end position.

i Note

Initialization is not possible in manual mode.

i Note





The 0 % and 100 % end positions depend on the operating direction used (see Annex A).

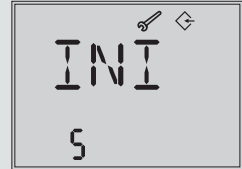
- Before initialization, mount the actuator on the valve as described in the 'Installation' section.
 - Set the automatic mode (see the 'Operation' section).
-


Start-up and configuration

Code	Description	WE	Adjustment range
5	Start initialization		INI

How to proceed:

1. Turn  (when the start screen appears) to select Code 5.
 2. Press . **INI** blinks on the display.
 3. Press  again. **INI** and the  icon appear. Initialization starts.
- Initialization can be canceled at all times by selecting ESC.






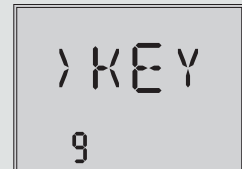
- After the initialization has been successfully completed, OK is indicated.
4. Press  to confirm.
- **The actuator is ready for use.**




7.2 Configuring the actuator

When the key number is active, proceed as follows:

1. Turn  (when the start screen appears) to select Code 9.
 2. Press  to confirm.
- Display: Input field for key number
3. Press  to activate the input field.




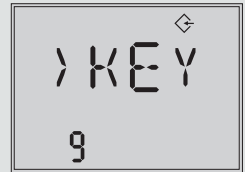
4. Turn  to enter the service key number.


→ The service key number can be found at the end of these mounting and operating instructions.



5. Press  to confirm.



→  icon indicates that the configuration level is enabled to change the parameter.



After entering the key number, the corresponding levels are enabled for five minutes (indicated by  icon). The levels are automatically locked again after five minutes.

Levels can also be locked again: Select Code 9 again. **OFF** is displayed. After confirming it by pressing , the  icon disappears.

7.2.1 Fast configuration level

Code 8 opens the fast configuration level, which allows the selection of several parameter configurations.

Code	Description	Display	Adjustment range
8	Fast configuration	FCO	In, Out, dir (see table below)

The settings for the following areas can be selected:

- Input signal (Code In)
- Position feedback signal (Code Out)
- Operating direction (Code dir)



Start-up and configuration

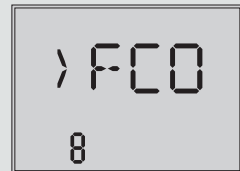
Code	Description	Display
In	Input signal 0 to 20 mA	0 – 20
	Input signal 4 to 20 mA	4 – 20
	Input signal 0 to 10 V	0 – 10
	Input signal 2 to 10 V	2 – 10
Out	Position feedback signal 0 to 20 mA	0 – 20
	Position feedback signal 4 to 20 mA	4 – 20
	Position feedback signal 0 to 10 V	0 – 10
	Position feedback signal 2 to 10 V	2 – 10
dir	Operating direction increasing/increasing	>>
	Direction of action: increasing/decreasing	<>

i Note

Only one setting can be selected for each range. Selected settings are marked on the display by dashes.

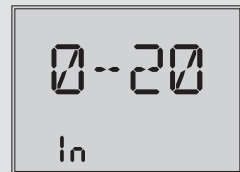
Open fast configuration level

1. Turn  (when the start screen appears) to select Code 8 (display: FCO).
2. Press . First setting that can be selected appears.




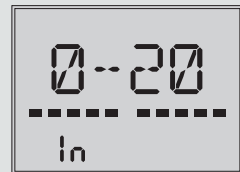
Selectable setting


→ Code In, input signal 0 to 20 mA



Select setting

3. Press  to select setting (indicated by the dashes).



4. Turn  to open other selectable settings
(see list on page 7-3).

Example shown: Code **dir**, operating direction increasing/
increasing selected.



7.3 Selecting the application

The actuator's application can be selected from one of the following applications:

- Positioner (POSI)
- PID controller (PID)
- Two-step mode (2STP)
- Three-step mode (3STP)
- Temperature closed-loop control upon input signal failure (POSF)

(see Annex A for description of functions)

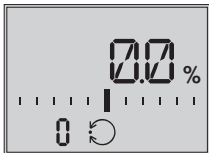
i Note

- Depending on the selected application, wire the terminals of the actuator as specified (see the 'Installation' section).
- Not all parameters and settings are shown when a certain application is selected.

Code	Description	WE	Adjustment range
6	Application	POSI	POSI (positioner) PID (PID controller) 2STP (two-step mode) 3STP (three-step mode) POSF (temperature closed-loop control upon input signal failure)

Positioner application (see Annex A for description)

- ➔ Set Code 6 to POSI.
- ➔ Perform the wiring as described in the 'Installation' section.



Displayed reading: travel

Fig. 7-1: Start screen with positioner application (POSI)

PID controller application (see Annex A for description)

- Set Code 6 to PID.
- Perform the wiring as described in the 'Installation' section.



Displayed reading: process variable

Fig. 7-2: Start screen with PID controller (PID) application

Two-step mode application (see Annex A for description)

- Set Code 6 to 2STP.
- Perform the wiring as described in the 'Installation' section.



Displayed reading: state

Fig. 7-3: Start screen with two-step mode application (2STP)

Three-step mode application (see Annex A for description)

- Set Code 6 to 3STP.
- Perform the wiring as described in the 'Installation' section.



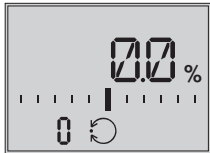
Displayed reading: state

Fig. 7-4: Start screen with three-step mode application (3STP)

Start-up and configuration

Temperature closed-loop control upon input signal failure application (see Annex A for description)

- Set Code 6 to POSF.
- Perform the wiring as described in the 'Installation' section.



Displayed reading: travel

Fig. 7-5: Start screen with temperature closed-loop control upon input signal failure application (POSF)

i Note

The 0 to 10 V or 0 to 20 mA setting for the input signal is not possible in combination with this function. The lower value must be at least 0.5 V or 1 mA.

7.4 Adjusting the limit contacts

i Note

To undo the screws on the housing cover, use a POZIDRIV® PZ2 screwdriver to get enough hold on the screw heads.

Mechanical limit contacts (see Fig. 7-6 to Fig. 7-8)

1. Undo screws on housing cover and take the cover off the actuator.
2. Switch on supply voltage.
3. Move the valve, using manual override or the "manual level" operating mode, to the point at which the contact should react.
4. Use a hex screwdriver to turn the spindle of the adjustment gears (18) for the upper limit contact or for the lower limit contact until the associated contact cam (19) of the contact cam unit (21) triggers the switch contact of the upper or lower microswitch on the terminal board (17).
5. Replace cover. Briefly turn the fastening screws counterclockwise with a screwdriver to center them. Then fasten down the cover by tightening the screws.

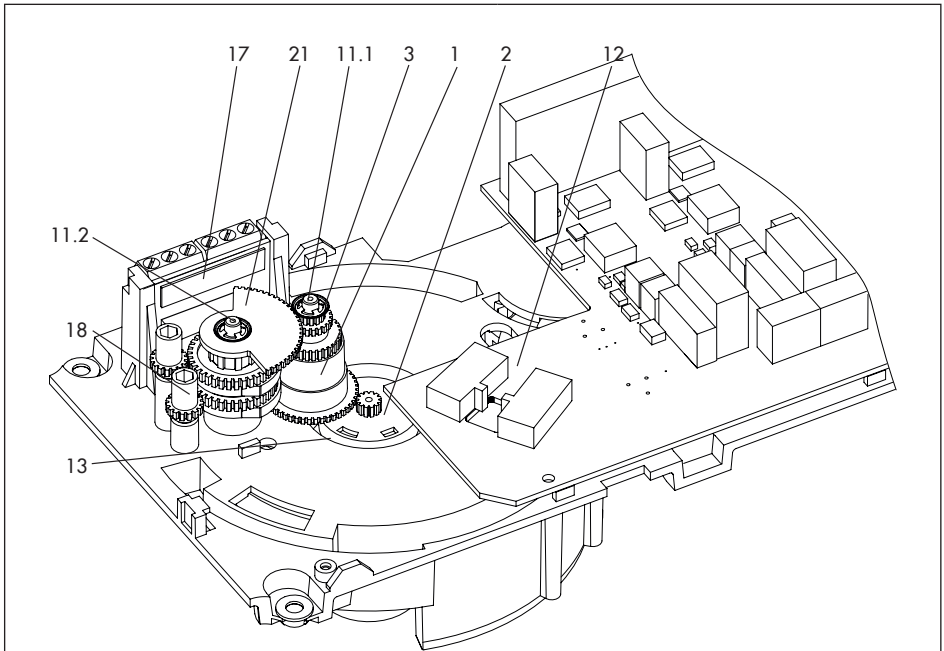


Fig. 7-6: Installing the limit contacts

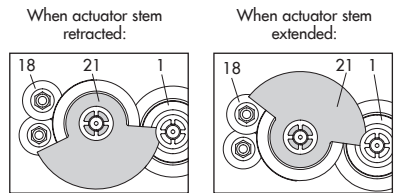
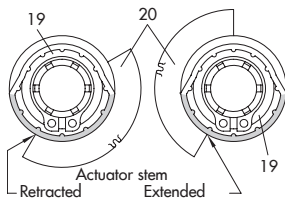


Fig. 7-7: Alignment of contact cam to the cam holder **Fig. 7-8:** Alignment of the contact cam unit

1	Intermediate gear	13	Bearing sleeve
2	Spindle gear	17	Terminal board
3	Serrated ring	18	Adjustment gear
11.1	Spindle 1	19	Contact cam
11.2	Spindle 2	20	Cam holder
12	Actuator board	21	Contact cam unit

Start-up and configuration

Electronic limit contacts

The electronic limit contacts are adjusted at the operating controls of the actuator (see Annex A).

7.5 Setting up communication

In the communication level, details and possible settings for the actuator interfaces are displayed. Codes of the communication level have an 'A' prefix to identify them.

Activating and setting parameters

Activate the communication level

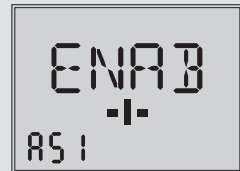
1. Turn  (when the start screen appears) to select Code 23.

→ Code A51 is displayed.






Activating parameters



→ Turn  to select the required code.

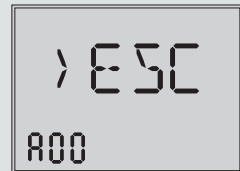


Setting parameters

1. Press . The reading blinks on the display.
2. Turn  until the required setting is reached.
3. Press  to confirm the setting.

Exiting the communication level

1. Turn  to select the code A00 (ESC).
2. Press  to exit communication level.



7.5.1 Serial interface

The RS-232 interface is used for communication with TROVIS-VIEW (SSP protocol) and ready for use by default.

7.5.2 Modbus RTU module

The electric actuator can be connected to a control station over Modbus and can be configured using TROVIS-VIEW. For this purpose, the actuator with firmware version 3.10 and higher can be fitted with an RS-485 module. Various communications protocol (SSP or Modbus RTU slave) are used for various functions.

For Modbus RTU communication, the RS-485 module (order no. 1402-1522) must be inserted into the actuator.

→ Excerpt from Modbus list: see Annex A.

Protocol

– Setting: automatic

The SSP and Modbus RTU protocols are automatically detected: the interface parameters are fixed internally to Baud rate 9600 bit/s, 8 data bits, no parity, 1 stop bit. The electric actuator can exchange data with TROVIS-VIEW or the control station without switching over. The station address and bus failure monitoring are adjustable.

– Setting: Modbus RTU

Communication is based on the Modbus RTU protocol. All interface parameters listed in Table 7-2 are adjustable.

Station address (Code A64)

The station number is used to identify the electric actuator for the Modbus RTU protocol.

Baud rate (Code A65)

It is the transmission rate between the electric actuator and control station/computer. The Baud rate adjusted at the electric actuator must be the same as that in the control station. Otherwise, no communication is established.

Stop bit and parity (Code A66)

The number of stop bits and the parity are set in Code A66. The parity is used to detect data transmission errors. The parity bit is added to the end of the string of data bits and the total value is made up from the data and parity bit.

Bus failure monitoring (Code A67)

The external manual level of the communication is monitored by the bus failure monitoring (timeout). After a bus failure is detected, automatic operation is reestablished. The time for the bus failure monitoring is adjustable. Set the value to 0 to deactivate bus failure monitoring.

Start-up and configuration

Table 7-2: *Modbus RTU parameter*
(setting in the communication level, see the 'Operation' section)

Code	Parameters	Display/select (select ESC to cancel)
Serial interface		
A51	Communication	ENAB (enabled) DISA (disabled)
Interface module		
A61	Communication	ENAB (enabled) DISA (disabled)
A62	Interface module	485 (RS-485) USB (USB) ETH (Ethernet) NONE (none)
A63	Protocol	AUTO (automatic: SSP, Modbus) MODX (Modbus, adjustable)
Modbus interface module		
A64	Station address	1 to 247
A65	Baud rate (in Baud)	1200 2400 4800 9600 192 (19200) 384 (38400)
A66	Stop bits and parity	1SNP (1 stop bit, no parity) 1SEP (1 stop bit, even parity) 1SOP (1 stop bit, odd parity) 2SNP (2 stop bits, no parity)
A67	Bus failure monitoring in min (timeout)	0 to 99
A00	Exit level	> ESC

8 Setup

8.1 Automatic mode

The behavior of the actuator in automatic mode depends on the application selected (see the 'Design and principle of operation' section for a description).

A constant supply voltage must be applied to the actuator to allow it to operate (see the 'Installation' section).



8.1.1 Information level

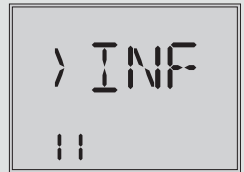
In the information level, all the actuator data important for closed-loop operation are displayed. Codes of the information level have an 'i' prefix to identify them.

All the parameters of the information level are listed in Annex A.



Activating parameters

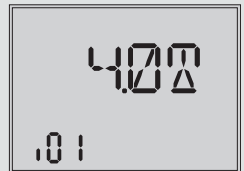
Activate the information level

1. Turn  (when the start screen appears) to select Code 11.
2. Press  to activate the information level.
(display: **i01**).





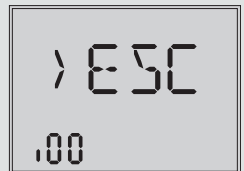
Activating parameters

- Turn  to activate the required code.
In this example:
Code i01, Lower range value of input signal (the  icon stands for the mA unit).



Exit information level

1. Turn  to select the code i00 (ESC).
2. Press  to exit information level.





8.1.2 Operating level

The operating level is active while the actuator is in the automatic mode. In this level, important information on the operation is shown, the operating mode is selected and the initialization started. The other levels are accessible from the operating level.

All the parameters of the operating level as well as fatal and EEPROM errors are listed in the 'Malfunctions' section.

8.1.2.1 Selecting the operating mode

The actuator is normally in automatic mode indicated by the  icon (displayed in Code 0 to 3). In automatic mode, the actuator stem follows the input signal according to the functions set in the configuration level.

In manual mode, the actuator stem moves to the adjusted manual positioning value. An active manual mode is indicated in Code 0 by the  icon.

Code	Description	WE	Adjustment range
2	Operating mode	AUTO	AUTO (automatic mode) MAN (manual mode)
3	Positioning value (manual mode)	–	0.0 to 100.0 %

Note

The positioning value (manual mode) selected in Code 3 must be adjusted by the amount corresponding to at least half the dead band (adjustable in c67, see the 'Start-up and configuration' section). Otherwise, the actuator stem will not move.

Example: Dead band adjusted to 2.0 % (default setting)

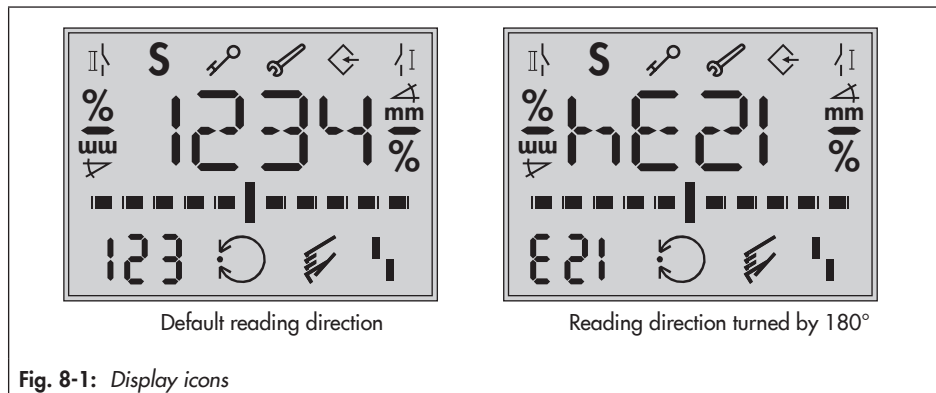
→ The positioning value (manual mode) must be adjusted by at least 1.0 % (for example, moving the actuator stem from 2.2 % to 3.2 %).

8.1.2.2 Determining the reading direction

The display contents can be turned by 180° in Code 4 to adapt the display reading to the actuator's mounting situation.

Code	Description	WE	Adjustment range
4	Reading direction	DISP	DISP, dSID

On changing the reading direction, the position of the icons and bar graph reading remains unchanged, while the segments for numbers, text as well as binary input and output are turned by 180°:



8.1.2.3 Switching on the backlight

The display backlight can be changed to be always switched on in Code c93.

Code	Description	WE	Adjustment range
c93	Backlight always on	NO	NO YES

i Note

- Regardless of the setting in Code c93, the backlight starts to blink whenever an error occurs (see the 'Malfunctions' section).
- The display backlight can also be switched on and off by the binary input (see the 'Start-up and configuration' section).

8.2 Manual mode

The actuator stem can be moved mechanically or electrically.

8.2.1 Mechanical override

For mechanical manual override, use the handwheel (1, see Fig. 8-2) which can only be operated when the power supply is disconnected.

i Note

A mechanical override is not possible for actuators with fail-safe action. These actuators do not have a handwheel.

⚠ WARNING

Risk of injury while the fold-away handle is being folded or unfolded.

→ *Take care when folding or unfolding the handle.*

Turn the handwheel (1) clockwise to move the actuator in 'aL' direction and counterclockwise to move it in the 'eL' direction (see Fig. 8-3).

- Do not operate the manual override while the actuator is in operation or while the voltage supply is still connected.
- Unfold and lock the fold-away handle (2) in place.

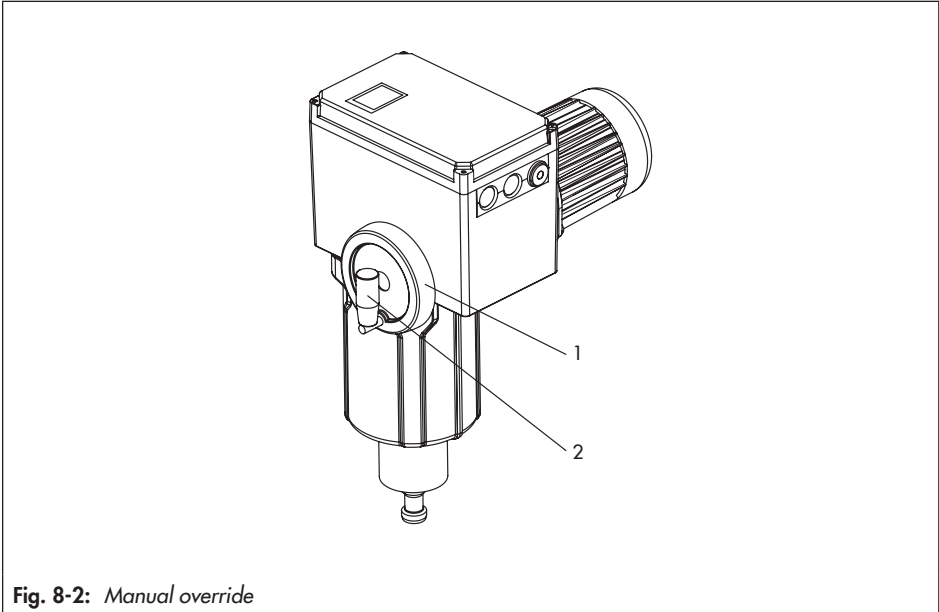


Fig. 8-2: *Manual override*

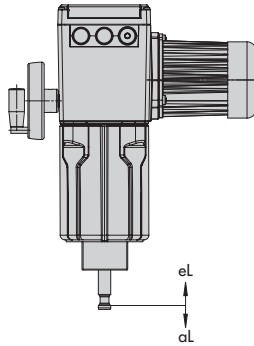




Fig. 8-3: Direction of action

8.2.2 MAN mode

The actuator is normally in automatic mode indicated by the  icon (displayed in Code 0 to 3). In MAN mode, the actuator stem moves to the adjusted manual positioning value. An active manual mode is indicated in Code 0 by the  icon. The positioning value can be adjusted in Code 3.

Code	Description	WE	Adjustment range
2	Operating mode	AUTO	AUTO (automatic mode) MAN (manual mode)
3	Positioning value (manual mode)	-	0.0 to 100.0 %

8.3 Operation using memory pen

The memory pen is optional (accessories) and is used to store and transfer data:



The memory pen can be configured in TROVIS-VIEW. The following functions for the actuator can be selected:

- Read data from the memory pen
- Write data to the memory pen
- Time-controlled data logging
- Event-triggered data logging
- Command mode

Refer to the operating instructions for TROVIS-VIEW for details on how to configure the memory pen:

► EB 6661.

8.3.1 Memory and data logging function

1. Open the actuator cover.
2. Insert the memory pen into the serial interface of the actuator.
 - ➔ The actuator automatically recognizes the memory pen. The dialog for the memory pen is displayed. The function (command) selected in TROVIS-VIEW is represented by a code on the display (see Table 8-1).
3. Select the required action using the rotary pushbutton (depending on the function selected. See Table 8-2).
 - ➔ **OK** is displayed after data transmission is completed.
4. Remove memory pen after data transmission is completed.

Setup

- The memory pen dialog ends. The start screen appears.
Close the actuator cover.

Table 8-1: *Memory pen dialog*

Code	Function	Action	Text
S02/ S03	Read data from memory pen/ Write data to memory pen	Reading memory pen/ Writing on memory pen	READ WRIT
S10	Time-controlled data logging	Data logging in progress	TLOG
S11	Event-triggered data logging	Data logging in progress	ELOG

Table 8-2: *Memory pen error*

Code	Error	Text
E51	Read error (memory pen)	ERD
E52	Write error (memory pen)	EWR
E53	Plausibility error	EPLA

8.3.2 Command function

The following executable commands can be written to the memory pen in TROVIS-VIEW:

- Retract actuator stem
- Extend the actuator stem

These commands turn a memory pen into a command pen. After inserting the command pen into the actuator's interface, all functions running are ended and the command is executed since the command pen has priority over all functions.

i Note

- *A command pen remains active as long as it is inserted into the actuator's interface (even after a reset).*
 - *Only one command at a time can be written to the memory pen and executed.*
-

Using the command pen

1. Open the actuator cover.
2. Insert the command pen into the serial interface of the actuator.
 - ➔ The actuator automatically recognizes the command pen. The dialog for the command pen is displayed. The function (command) selected in TROVIS-VIEW is represented by a code on the display (see Table 8-3).
3. Remove command pen after the command has been executed.
 - ➔ The command pen dialog ends. The start screen appears.
4. Close the actuator cover.

Table 8-3: *Command pen dialog*



Code	Command/function	Text
S21	Retract actuator stem	IN
S22	Extend the actuator stem	OUT

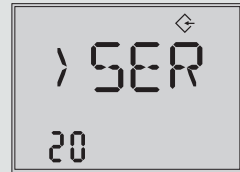
8.4 Service mode

The service level contains detailed information on the actuator and its operating state. Additionally, various test functions can be performed in this level. Codes in the diagnostic level have a 'd' prefix to identify them.




All the parameters of the service level are listed in Annex A.

Activate the service level

1. Turn  (when the start screen appears) to select Code 20.
2. Press  to activate the service level.
(display: **d01**).





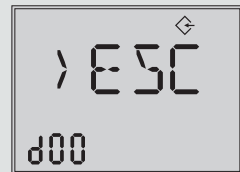
Example shown: Start transit time measurement

1. Turn  to activate Code d61.
 2. Press . The reading blinks on the display.
 3. Press  again to start the transit time measurement.
- The transit time measurement can be canceled at all times by selecting **ESC**.



Exiting the service level

1. Turn  to select the code d00 (ESC).
2. Press  to exit the service level.



8.4.1 Zero calibration

WARNING

Risk of injury due to the actuator stem extending or retracting.

→ *Do not touch or block the actuator stem.*

NOTICE

The process is disturbed by the movement of the actuator stem.

→ *Do not perform the zero calibration while the process is running. First isolate the plant by closing the shut-off valves.*

The actuator stem moves to the 0 % end position. Following this, the actuator changes to closed-loop operation and moves the actuator stem to the position defined by the input signal.

Code	Description	Adjustment range
d51	Start zero calibration	ZER

→ Zero calibration can be canceled at all times by selecting **ESC**.

8.4.2 Initializing the actuator

⚠ WARNING

Risk of injury due to the actuator stem extending or retracting.

→ *Do not touch or block the actuator stem.*

ⓘ NOTICE

The process is disturbed by the movement of the actuator stem.

→ *Do not perform the initialization while the process is running. First isolate the plant by closing the shut-off valves.*

→ The procedure is described in the 'Start-up and configuration' section.

Code	Description	WE	Adjustment range
d52	Start initialization		INI

→ Initialization can be canceled at all times by selecting **ESC**.

8.4.3 Restarting the actuator (reset)

The actuator can be restarted by performing a reset. Upon restart, the actuator goes into the operating mode previously set unless a different restart condition has been defined (see the 'Start-up and configuration' section).

Code	Description	Adjustment range
d53	Perform reset	RES

8.4.4 Loading the default settings

All the parameters of the configuration level can be reset to their default settings (WE).



Code	Description	Adjustment range
d54	Load default settings in actuator	DEF

8.4.5 Testing the display



All the segments of the display are shown during the display test when a display functions properly. The display test is performed by selecting Code d55 in the service level (Code 20).

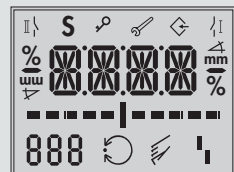
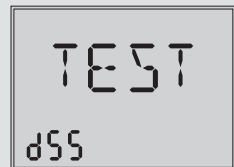
Code	Description	Adjustment range
d55	Testing the display	TEST (all segments displayed)

Activate display test (service level/Code 20)

1. Turn  (when the start screen appears) to select Code d55 (display: **TEST**).
2. Press  to start test.

→ All segments are shown.

3. Press  to hide all segments (backlight remains switched on)
4. Press  again to return to the **d55 TEST** reading.



8.4.6 Measuring the transit time

⚠ WARNING

Risk of injury due to the actuator stem extending or retracting.

→ Do not touch or block the actuator stem.

ⓘ NOTICE

The process is disturbed by the movement of the actuator stem.

→ Do not perform the transit time measurement while the process is running. First isolate the plant by closing the shut-off valves.

During transit time measurement, the actuator stem moves from its current position to the 0 % end position. Starting from the 0 % end position, the actuator stem moves to the 100 % end position and back again to the 0 % end position. The transit time is measured during the up and down strokes and the average transit time calculated.

After the measurement is completed, the actuator returns to the operating mode last used.

i Note

The 0 % and 100 % end positions depend on the operating direction used (see the 'Start-up and configuration' section).

Code	Description	Adjustment range
d61	Start transit time measurement	RUN
d62	Measured transit time in s	► Read only
d63	Measured travel in mm	► Read only
d64	Speed level ¹⁾	► Read only


¹⁾ It is not possible to select between different speed levels in the actuator. As a result, **NORM** is always displayed in d64.

→ The transit time measurement can be canceled at all times by selecting **ESC**.

9 Malfunctions

9.1 Troubleshooting

9.1.1 Error messages

Active errors are added at the end of the top operating level. An error is indicated by the display blinking and alternating between the start screen and the indicated error with the  error icon. If several errors have occurred, only the error with the highest priority is shown on the start screen. In the operating level, the active errors appear on the display after Code 20.

Error messages in order of their priority:

Error		Message	Type of error	Priority
EF	ENDT	Final test failed	Fatal error	1
E11	NTRV	EEPROM error: no basic setting	Fatal error	2
E12	NCO	EEPROM error: no configuration	Fatal error	3
E08	PLAU	Plausibility error	Fatal error	4
E06	MOT	Motor or potentiometer not turning	Fatal error	5
E03	SWI	Both limit contacts are active	Fatal error	6
E04	SIN	Retracting of actuator stem canceled	Fatal error	7
E05	SOUT	Extending of actuator stem canceled	Fatal error	8
E02	BLOC	Blockage	Fatal error	9
E01	FAIL	Input signal failure (application: positioner)	Fatal error	10
		Input signal failure (application: temperature closed-loop control upon input signal failure)	Maintenance demanded	
E07	SENS	Sensor failure (application: PID controller)	Fatal error	11
		Sensor failure (application: temperature closed-loop control upon input signal failure)	Maintenance demanded	
E09	BUS	Bus failure	Fatal error	12
E14	NPOT	EEPROM error: no potentiometer calibration	Maintenance demanded	13
E00	RUNT	No initialization performed	Maintenance demanded	14
E13	NCAL	EEPROM error: no calibration	Maintenance demanded	15
E15	NRUN	EEPROM error: no transit time	Maintenance demanded	16

Comment on plausibility error

Due to an invalid combination of interacting parameters in the configuration level, a plausibility error arises which is indicated by **PLAU** blinking on the display. A correction of the interacting parameters clears the error message.

Causes of plausibility error

- **Invalid application selected (when Code c01 = C):**
"Pt 1000" (Code c01 = **C**) is set as the source (only available for PID controller application, Code 6 = **PID**). Afterwards, the application is changed to "Positioner" (Code 6 = **POSI**) or "Temperature closed-loop control upon input signal failure" (Code 6 = **POSF**), causing a plausibility error.
Recommended action: Set Code 6 to PID controller.
- **Invalid application selected (when Code c01 = VIA):**
"Interface" is set as the source (Code c01 = **VIA**). Afterwards, the application is changed to "Temperature closed-loop control upon input signal failure" (Code 6 = **POSF**), causing a plausibility error.
Recommended action: Set Code 6 to Positioner or PID controller.
- **Invalid value for lower range value (Code c02):**
A value <1.0 mA or <0.5 V is set in Code c02 combined with an active detection of input signal failure (Code c31 = **YES**).
Recommended action: Set Code c31 to NO or c02 to a value ≥ 1.0 mA or ≥ 0.5 V.
- **Invalid value for lower range value during fast configuration (FCO):**
Lower range value (Code c02) and active detection of input signal failure (Code c31 = **YES**) are a valid combination. However, a plausibility error arises if an input signal from 0 to 20 mA or 0 to 10 V is selected through fast configuration (**FCO**).
Recommended action: Set Code c02 to a value ≥ 1.0 mA or ≥ 0.5 V.
- **Invalid set point (Code c81):**
The set point (Code c81) is not within the range defined by the lower (Code c86) and upper adjustment limits (Code c87).
Recommended action: Set the set point (Code c81) or the adjustment limits (Code c86/c87) so that the set point is within the adjustment limits.
- **Invalid limits of process variable range (Code c88/c89):**
The set point (Code c81) is within the range defined by the lower (Code c86) and upper adjustment limits (Code c87). The lower limit of process variable range (Code c88) has a greater value than the lower adjustment limit (Code c86) or the upper limit of process variable range (Code c89) has a lower value than the upper adjustment limit (Code c87).

Recommended action:

- Adjust the limits of the process variable range (Code c88/c89) so that they are identical to the adjustment limits (Code c86/c87) or that the adjustment limits (Code c86/c87) are within the limits of the process variable range (Code c88/c89). See Annex A.



We recommend performing a reset to default settings and reconfiguration (see the 'Operation' section) if plausibility problems due to changes in various parameters cannot be rectified.

Malfunctions

Troubleshooting

Code	Error	Corrective action to be taken
Fatal error		
EF	Final test failed	Contact our after-sales service.
E01	Input signal failure	Check signal source and wiring
E02	Blockage	Unblock stem and valve.
E03	Both limit contacts are active	Contact our after-sales service.
E04	Retracting of actuator stem canceled	Contact our after-sales service.
E05	Extending of actuator stem canceled	Contact our after-sales service.
E06	Motor or potentiometer not turning	Contact our after-sales service.
E07	Sensor failure	Check signal source and wiring
E08	Plausibility error	Correct configuration
E09	Bus failure	Check Modbus master and connection
E11	EEPROM error: no basic setting	Contact our after-sales service.
E12	EEPROM error: no configuration	Perform configuration again
Maintenance demanded		
E01	Input signal failure	Check signal source and wiring
E07	Sensor failure	Check signal source and wiring
E00	No initialization performed	Perform an initialization
E13	EEPROM error: no calibration	Contact our after-sales service.
E14	EEPROM error: no potentiometer calibration	Contact our after-sales service.
E15	EEPROM error: no transit time	Perform an initialization or transit time measurement
Warnings (over service level)		
d41	EEPROM error: no serial number	Contact our after-sales service.
d42	EEPROM error: no manufacturing parameters	Contact our after-sales service.
d44	EEPROM error: no status messages	Contact our after-sales service.
d45	EEPROM error: no statistics	Contact our after-sales service.

i Note

EEPROM errors are marked by 'E RD' on the display when they are read errors and 'E WR' when they are write errors.

9.1.2 Other malfunctions or errors

→ Troubleshooting (see Table 9-1)

i Note

Contact SAMSON's After-sales Service for malfunctions not listed in the table.

Table 9-1: Troubleshooting

Error	Possible reasons	Recommended action
Actuator stem does not move.	Actuator is blocked.	→ Check attachment. → Remove the blockage.
	No or incorrect supply voltage connected.	→ Check the supply voltage and connections.
	Incorrect configuration or incorrect application	→ Check the actuator configuration
Actuator stem does not move through the whole range.	No or incorrect supply voltage connected.	→ Check the supply voltage and connections.

9.2 Emergency action

The valve, on which the actuator with fail-safe action is mounted, is moved to its fail-safe position upon failure of the supply voltage (see the 'Design and principle of operation' section). Plant operators are responsible for emergency action to be taken in the plant.

Tip

Emergency action in the event of valve failure is described in the associated valve documentation.

10 Servicing

i Note

The electric actuator was checked by SAMSON before it left the factory.

- The product warranty becomes void if service or repair work not described in these instructions is performed without prior agreement by SAMSON's After-sales Service.*
 - Only use original spare parts by SAMSON, which comply with the original specifications.*
-

The actuator requires no maintenance.

11 Decommissioning

The work described in this section is only to be performed by personnel appropriately qualified to carry out such tasks.

⚠ DANGER

Risk of fatal injury due to electric shock.

- Before disconnecting live wires, switch off the supply voltage at the actuator and protect it against unintentional reconnection.

⚠ WARNING

Risk of personal injury due to residual process medium in the valve.

While working on the valve, residual medium can flow out of the valve and, depending on its properties, cause personal injury, e.g. (chemical) burns.

- Wear protective clothing, safety gloves and eye protection.

⚠ WARNING

Risk of burn injuries due to hot or cold components and pipeline.

Valve components and the pipeline may become very hot or cold. Risk of burn injuries.

- Allow components and pipelines to cool down or warm up to the ambient temperature.
- Wear protective clothing and safety gloves.

To decommission the electric actuator for repair work or disassembly, proceed as follows:

- Put the control valve out of operation (see associated valve documentation).
- Disconnect the supply voltage and protect it against unintentional reconnection.
- Make sure that a signal from the controller cannot act upon the actuator.

i Note

For versions with "actuator stem extends" fail-safe action, the supply voltage must remain connected to prevent the actuator stem extending by itself.

12 Removal

The work described in this section is only to be performed by personnel appropriately qualified to carry out such tasks.

⚠ DANGER

Risk of fatal injury due to electric shock.

→ *Before disconnecting live wires, switch off the supply voltage at the actuator and protect it against unintentional reconnection.*

Actuator without fail-safe action

1. Disconnect the supply voltage and protect it against unintentional reconnection.
2. Make sure that a signal from the controller cannot act upon the actuator. If necessary, disconnect the wires connecting the controller.
3. Disconnect the wires of the connecting lines at the actuator.
4. Remove the connecting lines.
5. Retract actuator stem as described in the 'Operation' section.
6. Undo the stem connector parts between the plug and actuator stems.
7. Unscrew the ring nut on the valve bonnet.
8. Lift the actuator off the valve.

Actuator with fail-safe action

1. Make sure that a signal from the controller cannot act upon the actuator. If necessary, disconnect the wires connecting the controller.
2. Retract the actuator stem electrically (eL terminal) in the MAN mode as described in the 'Operation' section.
3. Undo the stem connector parts between the plug and actuator stems.
4. Unscrew the ring nut on the valve bonnet.
5. Lift the actuator off the valve.
6. Disconnect the supply voltage and protect it against unintentional reconnection.
 - The actuator stem moves to the fail-safe position.
7. Disconnect the wires of the connecting lines.
8. Remove the connecting lines.

13 Repairs

If the actuator does not function properly according to how it was originally configured or does not function at all, it is defective and must be exchanged.

! NOTICE

Risk of actuator damage due to incorrect service or repair work.

- *Do not perform any repair work on your own.*
 - *Contact SAMSON's After-sales Service.*
-

13.1 Returning the actuator to SAMSON

Defective actuators can be returned to SAMSON for examination.

Proceed as follows to return devices:

1. Remove the electric actuator from the valve (see the 'Removal' section).
2. Continue as described on our website at
 - ▶ www.samsongroup.com > Service & Support > After-sales Service > Returning goods

14 Disposal



We are registered with the German national register for waste electric equipment (stiftung ear) as a producer of electrical and electronic equipment, WEEE reg. no.: DE 62194439

- Observe local, national and international refuse regulations.
- Do not dispose of components, lubricants and hazardous substances together with your other household waste.



Tip

On request, we can appoint a service provider to dismantle and recycle the product.

15 Certificates

The following certificate is shown on the next page:

– EU declaration of conformity

The certificate shown was up to date at the time of publishing. The latest certificate can be found on our website at:

▶ www.samsongroup.com > Products & Applications > Product selector > Actuators > 3375

EU declaration of conformity

SMART IN FLOW CONTROL



EU Konformitätserklärung / EU Declaration of Conformity

Für das folgende Produkt / For the following product

Elektrischer Stellantrieb / Electric Actuator
Typ / Type 3375

— wird die Konformität mit den nachfolgenden EU-Richtlinien bestätigt / signifies compliance with the following EU Directives:

— EMC 2004/108/EC (bis/to 2016-04-19)
EMC 2014/30/EU (ab/from 2016-04-20)

EN 61000-6-2:2005, EN 61000-6-3:2010,
EN 61326-1:2013

— LVD 2006/95/EC (bis/to 2016-04-19)
LVD 2014/35/EU (ab/from 2016-04-20)

EN 60730-1:2011, EN 61010-1:2010

Hersteller / Manufacturer:

— SAMSON AKTIENGESELLSCHAFT
Weismüllerstraße 3
D-60314 Frankfurt am Main
Deutschland/Germany

Frankfurt, 2016-04-06

ex_3375-0_de_en_en05.pdf

i.V. Gert Nahler

Gert Nahler
Zentralabteilungsleiter/Head of Department
Entwicklung Automation und Integrationstechnologien/
Development Automation and Integration Technologies

ppa. Günther Scherer

ppa. Günther Scherer
Qualitätssicherung/Quality Management

SAMSON AKTIENGESELLSCHAFT
Weismüllerstraße 3 60314 Frankfurt am Main

Telefon: 069 4009-0 · Telefax: 069 4009-1507
E-Mail: samson@samson.de

Revision 05






16 Annex A (configuration instructions)

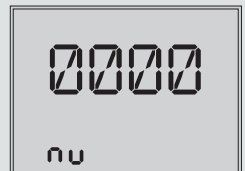
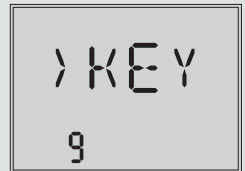
16.1 Key number


To change parameters in the configuration level, a key number can be activated in the actuator over Code c94. When the key number function is activated, the key number must be entered before the parameter setting can be changed. If a code is selected without entering a key number beforehand when the key number function is activated, **LOCK** is displayed and the parameter settings cannot be changed.

Code	Description	WE	Adjustment range
c94	Key number active	NO	NO (deactivated) YES (activated)


When the key number is active, proceed as follows:



1. Turn  (when the start screen appears) to select Code 9.
 2. Press  to confirm.
- Display: Input field for key number
3. Press  to activate the input field.
4. Turn  to enter the service key number.
- The service key number can be found at the end of these mounting and operating instructions.
5. Press  to confirm.



→  icon indicates that the configuration level is enabled to change the parameter.



After entering the key number, the corresponding levels are enabled for five minutes (indicated by  icon). The levels are automatically locked again after five minutes.

Levels can also be locked again: Select Code 9 again. **OFF** is displayed. After confirming it by pressing , the  icon disappears.

Customized key number

In addition to the fixed service key number, a customized key number can be used. It is entered in the same way as the service key number in Code 9 and is set by default to **0000**. You can change the customized key number in Code c92. The service key number becomes effective if the customized key number is deactivated in Code c91.

Code	Description	WE	Adjustment range
c91	Customized key number active	YES	NO (deactivated) YES (activated)
c92	Customized key number	0000	0000 to 1999

Tip

An additional write protection function can be achieved by deactivating the communication in Code A51 or Code A61 (see the 'Start-up and configuration' section).

16.2 Input signal

The input signal determines the actuator stem position. Either a current or voltage signal can be applied to the input depending on the configuration in Code c01. The default values for the lower range and upper range of the input signal are between 2 and 10 V or 4 to 20 mA. The input signal range can be adapted as required, e.g. to achieve a plant operation characteristic by connecting two or more actuators in parallel (split-range operation).

Example: Two valves regulate the process medium in one common pipeline to achieve a large rangeability. One valve opens with a 0 to 5 V input signal, while the second valve also opens when the input signal increases further (5 to 10 V) and the first valve remains open. The two valves close in the reverse order.

i Note

At least 2.5 V or 5 mA (depending on the input signal used) must separate the upper and lower range values.

Code	Description	WE	Adjustment range
c01	Source (depending on the selected application)	mA	mA (current signal) V (voltage signal) C (Pt 1000) VIA (via interface)
c02	Lower range value	2.0 V or 4.0 mA	0.0 to 7.5 V or 0.0 to 15.0 mA
c03	Upper range value	10.0 V or 20.0 mA	2.5 to 10.0 V or 5.0 to 20.0 mA

Detect input signal failure

The actuator detects a configured failure of the input signal and the error reading **E01** starts to blink on the display as soon as the input signal falls below the lower range value by 0.3 V or 0.6 mA. If the input signal failure function is active (c31 = YES), the reaction of the actuator upon failure of the input signal is determined by Code c32:

- **Internal positioning value (c32 = INT):** The actuator stem moves to the position specified in Code c33 upon failure of the input signal.
- **Last position (c32 = LAST):** The actuator stem remains in the last position that the valve moved to before failure of the input signal.

The error message is reset and the actuator returns to closed-loop operation if the input signal moves within 0.2 V or 0.4 mA of the lower range value.

Code	Description	WE	Adjustment range
c31	Detect input signal failure	NO	NO (function inactive) YES (function active)
c32	Positioning value upon input signal failure	INT	INT (internal positioning value) LAST (last position)
c33	Internal positioning value	0.0 %	0.0 to 100.0 %

i Note

The input signal must be $\geq 0.5 \text{ V}$ or $\geq 1 \text{ mA}$ to be able to detect a malfunction.

16.3 Direction of action

→ See Fig. 16-1.

- **Increasing/increasing (c42 = >>):**
The actuator stem retracts as the input signal increases.
- **Increasing/decreasing (c42 = <>):**
The actuator stem extends as the input signal increases.

Actuator stem extended

- With globe valves: Valve closed
- With three-way mixing valves: Port A → AB open, B → AB closed
- With three-way diverting valves: Port AB → A closed, AB → B open

Actuator stem retracted

- With globe valves: Valve open
- With three-way mixing valves: Port A → AB closed, B → AB open
- With three-way diverting valves: Port AB → A open, AB → B closed

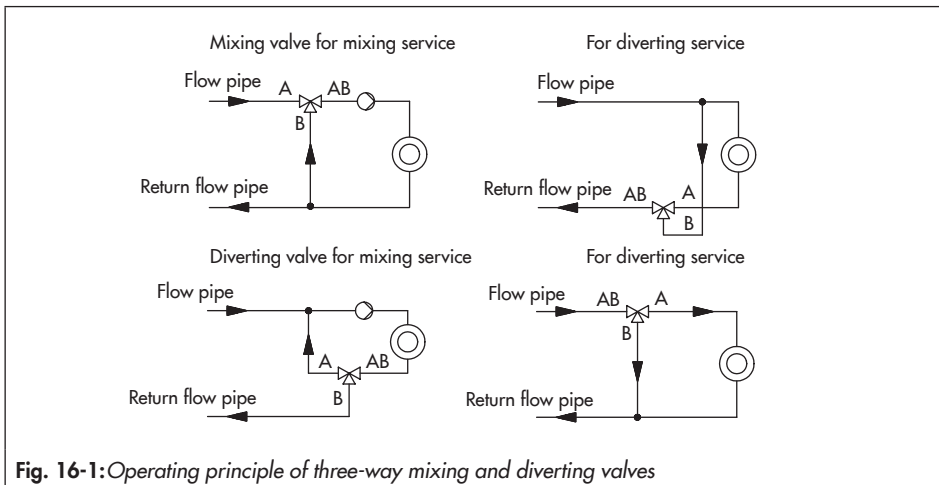


Fig. 16-1: Operating principle of three-way mixing and diverting valves

Code	Description	WE	Adjustment range
c42	Direction of action	>>	>> (increasing/increasing) << (increasing/decreasing)

16.4 End position guiding

Operating direction increasing/increasing

- **Value above limit (end position guiding) (c35):** The actuator stem moves the valve to the **top end position** if the input signal reaches the value entered in this code. Setting c35 = 100.0 % causes this function (end position guiding: valve open) with a retracting actuator stem to be deactivated.
- **Value below limit (end position guiding) (c36):** The actuator stem moves the valve to the **bottom end position** if the input signal reaches the value entered in this code. Setting c36 = 0.0 % causes this function (end position guiding: valve closed) with an extending actuator stem to be deactivated.

Direction of action: increasing/decreasing

- **Value above limit (end position guiding) (c35):** The actuator stem moves the valve to the **bottom end position** if the input signal reaches the value entered in this code. Setting c35 = 100.0 % causes this function (end position guiding: valve open) with a retracting actuator stem to be deactivated.
- **Value below limit (end position guiding) (c36):** The actuator stem moves the valve to the **top end position** if the input signal reaches the value entered in this code. Setting c36 = 0.0 % causes this function (end position guiding: valve closed) with an extending actuator stem to be deactivated.

Code	Description	WE	Adjustment range
c35	Value below limit (end position guiding)	97.0 %	50.0 to 100.0 %
c36	End position guiding when the value falls below the limit	1.0 %	0.0 to 49.9 %

The actuator stem moves to the end positions earlier if the end position guiding function is active.

16.5 Position feedback signal

The valve position feedback indicates the valve travel. It uses an analog signal issued at the terminal **U OUT** or **I OUT**. The span of the position feedback signal is adjusted over the *lower* and *upper range value* parameters.

i Note

- At least 2.5 V or 5 mA (depending on the input signal used) must separate the upper and lower range values.
- When *c37 = YES*, the position feedback signal is 12 V or 24 mA in the event of a fault.
- During initialization, transit time measurement or zero calibration, the position feedback signal = 0 V or 0 mA.

Code	Description	WE	Adjustment range
c05	Unit	mA	mA (current signal) V (voltage signal)
c06	Lower range value	4.0 mA	0.0 to 7.5 V or 0.0 to 15.0 mA
c07	Upper range value	20.0 mA	2.5 to 10.0 V or 5.0 to 20.0 mA
c37	Superimposing an error message	NO	YES (error reading active) NO (error reading inactive)

16.6 Binary input

The function of the binary input can be configured as required. Code c12 is used to determine the switching state for the active function. **c12 = NINV**: the binary input is active when the input terminals IN 4 +/IN 4 – are connected with each other. **c12 = INV**: The binary input is active when the connection between the input terminals **IN 4 +/IN 4 –** is interrupted.


- ➔ Do not connect an external supply voltage to the input terminals.
- **Inactive (c11 = NONE)**: No function is assigned to the binary input.
- **Priority position (c11 = PRIO)**: The priority position is triggered and the actuator stem moves to the position entered in Code c34 as soon as the binary input changes to the active switching state. The valve leaves the priority position and follows the input signal after the binary input changes to the inactive switching state.

- **Next entry in information level (c11 = NEXT):** If the **NEXT** function is selected in Code c11, the first code of the information level (i01) is displayed as soon as binary input switching state is changed. After every new change to the active state, the next code of the information level appears (i02, i03 etc.). The display returns to the start screen after all the codes of the information level have been displayed due to the binary input switching or when the binary input's switching state remains unchanged for five minutes.
- **Backlight (c11 = LAMP):** When the binary input's switching state is active, the display backlight is switched on permanently.
- **Exit manual level for travel adjustment (c11 = MEND):** When the binary input's switching state is active, the actuator exits the manual mode. The actuator stem moves to the valve position determined by the automatic mode.

Code	Description	WE	Adjustment range
c11	Function	NONE	NONE (inactive) PRIO (priority position) NEXT (next entry in information level) LAMP (backlight activated) MEND (exit manual level for travel adjustment)
c12	Switching state for active function	NINV	NINV (not inverted) INV (inverted)
When c11 = PRIO:			
c34	Travel for priority position	0.0 %	0.0 to 100.0 %

16.7 Binary output

The binary output is a floating contact. The function and switching state of the binary input can be configured as required.

- **Inactive (c15 = NONE):** No function is assigned to the binary output.
- **Error indication (c15 = FAIL):** when an error ( icon) is registered, the error message is issued at the binary output.
- **Limit contact (c15 = LIM):** the binary output is used as an electronic limit contact (see section 16.8). To configure this function, the required settings must be made in Codes c21 to c23. The use of the binary output as an electronic limit contact is independent from the optionally installed electronic limit contacts.
- **Priority position (c15 = PRIO):** When the priority position function is active (c11 = PRIO), this is registered at the binary output after the actuator stem stops moving.

Annex A (configuration instructions)

- **Adopt binary input's state (c15 = BIN):** The binary output reproduces the logical state of the binary input.
- **Indicate manual mode (c15 = MAN):** The binary output is active when the manual mode (MAN) is active (Code 2) or the manual level in TROVIS-VIEW is active.

Code	Description	WE	Adjustment range
c15	Function	NONE	NONE (inactive) FAIL (error indication) LIM (limit contact) PRIO (priority position) BIN (adopt binary input) MAN (indicate manual mode)
c16	Switching state for active function	NINV	NINV (not inverted) INV (inverted)
When c15 = LIM			
c21	Electronic limit contact (binary output) Message in case of event	NONE	NONE (inactive) HIGH (value above limit) LOW (value below limit)
c22	Switching point of limit contact (binary output)	10.0 %	0.0 to 100.0 %
c23	Hysteresis of electronic limit contact (binary output)	1.0 %	0.0 to 10.0 %

16.8 Electronic limit contacts

The electronic limit contact can be triggered by the actuator stem position exceeding or falling below an adjustable switching point.

- **Triggered when the position exceeds the switching point:** The limit contact is activated when the actuator stem position moves beyond the **switching point**. The limit contact is deactivated when the actuator stem moves below the switching point plus **hysteresis**.
- **Triggered when the position moves below the switching point:** The limit contact is activated when the actuator stem position moves below the **switching point**. The limit contact is deactivated when the actuator stem position moves beyond the switching point plus **hysteresis**.

i Note

An activated limit contact remains permanently active if the switching point is smaller or larger than the hysteresis. This limit contact can only be deactivated by a restart (see the 'Operation' section) or by resetting to **NONE** (c24, c27).

Code	Description	WE	Adjustment range
c24	Limit contact 1 Message in case of event	NONE	NONE (inactive) HIGH (value above limit) LOW (value below limit)
c25	Switching point of limit contact 1	10.0 %	0.0 to 100.0 %
c26	Hysteresis of limit contact 1	1.0 %	0.0 to 10.0 %
c27	Limit contact 2 Message in case of event	NONE	NONE (inactive) HIGH (value above limit) LOW (value below limit)
c28	Switching point of limit contact 2	90.0 %	0.0 to 100.0 %
c29	Hysteresis of limit contact 2	1.0 %	0.0 to 10.0 %

16.9 Restart


After the supply voltage returns upon a supply voltage failure, the actuator starts according to the restart conditions.

- **Normal (c43 = NORM):** The actuator remains in automatic mode and immediately follows the input signal.
- **Zero calibration (c43 = ZERO):** The actuator performs a zero calibration.
- **Fixed positioning value (c43 = FIX):** The actuator switches to the manual mode and moves the actuator stem to the *Fixed positioning value for restart*.
- **Stop in manual level (c43 = STOP):** The actuator switches to the manual mode and sets the last positioning value to be the same as the manual positioning value.

Code	Description	WE	Adjustment range
c43	Restart	NORM	NORM (normal) ZERO (zero calibration) FIX (fixed positioning value) STOP (stop in manual level)
When c43 = FIX			
c44	Fixed positioning value for restart	0.0 %	0.0 to 100.0 %

16.10 Blockage

Blockage detection (c51)

The actuator detects a valve blockage by comparing the travel after the torque-dependent switch has been triggered with the travel measured on initialization. If the comparison shows that the limit switch was triggered too early, this indicates that there is a valve blockage. A blockage is indicated on the display by the  icon.

Remove blockage (c52)

When the Blockage removal function is active, the actuator stem extends and retracts 1 mm three times at the most in sequence.

Blocking protection (c53)

The blocking protection prevents the valve from seizing up. If the actuator stem is in the closed position (0 %), it is extended slightly and then moved back to the closed position 24 hours after it last moved.

Code	Description	WE	Adjustment range
c51	Blockage detection	NO	NO (function inactive) YES (function active)
c52	Blockage removal	NO	NO (function inactive) YES (function active)
c53	Blocking protection	NO	NO (function inactive) YES (function active)

16.11 Travel

Limited travel range (c63)

The *Limited travel range* parameter determines in % how far the actuator stem can move at the maximum. The rated travel (c61) acts as the reference. When c63 = 100.0 %, the travel range is not limited.

Code	Description	WE	Adjustment range
c61	Rated travel	mm	► Read only
c63	Limited travel range	100.0 %	10.0 to 100.0 %

The transit time (c66) is calculated from the travel and the stroking speed (c65). The transit time is the time that the actuator stem needs to move through the adjusted travel. The following applies:

$$\text{Transit time in s} = \frac{\text{Travel in mm}}{\text{Stroking speed in mm/s}}$$

Code	Description	WE	Adjustment range
c65	Stroking speed	mm/s	► Read only
c66	Transit time	s	► Read only

Dead band (switching range)

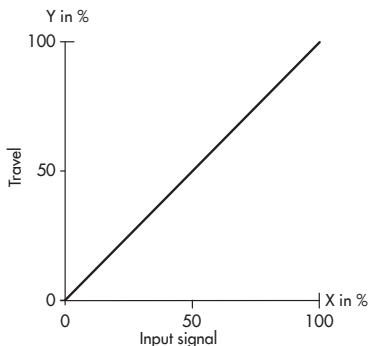
The dead band suppresses slight movements of the stem. The dead band represents the sum of the positive and negative hysteresis. After the actuator has been stationary, the input signal must change by at least half of the dead band to cause the actuator to move again.

Code	Description	WE	Adjustment range
c67	Dead band (switching range)	2.0 %	0.5 to 5.0 %

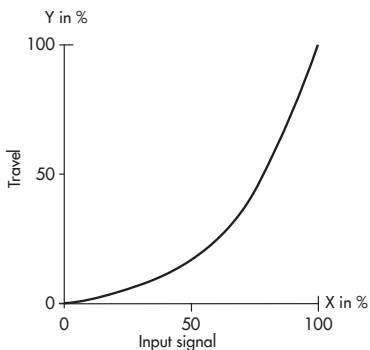
16.12 Characteristic

The characteristic expresses the relation between the input signal and the actuator stem's position.

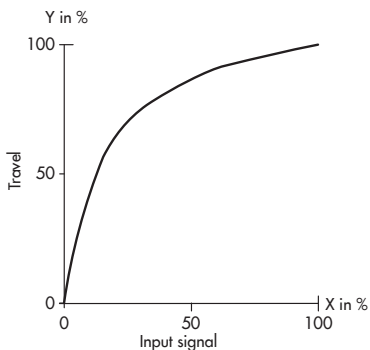
- **Linear (c71 = LIN):** The travel is proportional to the input signal.



- **Equal percentage (c71 = EQUA):** The travel is exponential to the input signal.



- **Reverse equal percentage (c71 = INV):** The travel is reverse exponential to the input signal.



- **User-defined (c71 = USER):** A new characteristic based on the last characteristic used can be defined over eleven points.

Code	Description	WE	Adjustment range
c71	Characteristic type	LIN	LIN (linear) EQUA (equal percentage) INV (reverse equal percentage) USER (user-defined)
When c71 = USER:			
c72 = USE	User-defined characteristic		
H0, Y0	Input signal X0, travel value Y0	0.0 %	0.0 to 100.0 %
H1, Y1	Input signal X1, travel value Y1	10.0 %	0.0 to 100.0 %
H2, Y2	Input signal X2, travel value Y2	20.0 %	0.0 to 100.0 %
H3, Y3	Input signal X3, travel value Y3	30.0 %	0.0 to 100.0 %
H4, Y4	Input signal X4, travel value Y4	40.0 %	0.0 to 100.0 %
H5, Y5	Input signal X5, travel value Y5	50.0 %	0.0 to 100.0 %
H6, Y6	Input signal X6, travel value Y6	60.0 %	0.0 to 100.0 %
H7, Y7	Input signal X7, travel value Y7	70.0 %	0.0 to 100.0 %
H8, Y8	Input signal X8, travel value Y8	80.0 %	0.0 to 100.0 %
H9, Y9	Input signal X9, travel value Y9	90.0 %	0.0 to 100.0 %
H10, Y10	Input signal X10, travel value Y10	100.0 %	0.0 to 100.0 %

16.13 Applications

Application: Positioner (POSI)

The actuator stem's position directly follows the input signal.

Application: PID controller (PID)

The set point adjustable at the actuator is used to position the valve using a PID algorithm. The input signal at **IN1**, **IN2** or **IN3** is used as the process variable. The PID controller is adjusted using the parameters: Proportional-action coefficient K_p , Reset time T_N , Derivative-action time T_V and Operating point Y_0 :

The proportional-action coefficient K_P acts as gain.

The reset time T_N is the time it takes for the integral component during a step response in a PI controller to produce a change in the manipulated variable identical to the change produced by the P component. Increasing the reset time T_N reduces the rate of change in the output when the set point deviation is constant.

The derivative-action time T_V is the time it takes the rise response of a PD controller to reach a certain manipulated variable value earlier than it would take the response with the P component only. Increasing the derivative-action time T_V causes an increase in the manipulated variable amplitude when the rate of change is constant. After ramped changes of the set point deviation, a longer derivative-action time T_V causes the D component to have a longer effect.

The operating point Y_0 determines the positioning value, which is fed to the controlled

system when the process variable is the same as the set point. The operating point is normally only important for P and PD controllers, but it can also be set for control strategies PI, PID and I due to the possible limitation of the integral-action component. For control strategies with integral-action component, the operating point can also be used as the initial value for a restart.

When the **PID** application is used for temperature control with a Pt 1000 sensor, the temperature sensor is connected at the **IN3** input (see the 'Installation' section). Pt 1000 sensors can also be connected to the **IN1** and **IN2** inputs. Their measured values can be read out over the RS-485 interface as Modbus data points (see section 16.16).

Application: Two-step mode (2STP)

The binary input **IN 2** is used for this function. When the binary input is in the active switching state, the actuator stem retracts to 100 % of the adjusted travel range. When the binary input is in the inactive switching state, the actuator stem moves to the closed position (0 %).

Application: Three-step mode (3STP)

The binary input **IN 2** is used for this function to retract the actuator stem and binary input **IN 3** to extend the actuator stem.

Application: Temperature closed-loop control upon input signal failure (POSF)

The travel follows the input signal. Upon failure of the input signal, the set point determined in the actuator by the integrated PID controller is used to position the stem.


16.14 Levels and parameters

16.14.1 Information level

Code	Parameters (read only)	Reading/unit	Section
Input signal			
i01	Lower range value of input signal	V or mA ¹⁾	Start-up and configuration
i02	Upper range value of input signal	V or mA ¹⁾	
i03	Positioning value	%/state	
i04	Unit	V or mA ¹⁾	
Control			
i05	Valve position	%/°C/bar/without unit	Design and principle of operation
i06	Set point	%/°C/bar/without unit	
i07	Error signal	%	
i08	Active controller	State	
i09	Positioning value	%	
Travel			
i11	Actuator travel	%	Start-up and configuration
i12	Actuator travel	mm	
Position feedback signal			
i21	Lower range value of position feedback signal	V or mA ¹⁾	Start-up and configuration
i22	Upper range value of position feedback signal	V or mA ¹⁾	
i23	Position feedback signal	%	
i24	Position feedback signal	V or mA ¹⁾	
Binary signals			
i31	Binary input status	ON/OFF	Start-up and configuration
i32	Binary output status	ON/OFF	
Limit contact			
i41	Status of limit switch (stem retracted)	ON/OFF	Start-up and configuration
i42	Status of limit switch (stem extended)	ON/OFF	

Annex A (configuration instructions)

Code	Parameters (read only)	Reading/unit	Section
Configuration			
i51	Direction of action	>>/<<	Start-up and configuration
i52	Limited travel range	%	
i53	Transit time	s	
i54	Application	POSI/PID/2STP/3STP/POSF	
Diagnostics			
i61	Travel cycles	From 10000 onwards, reading in K	
i62	Temperature inside actuator	°C	
i63	Lowest temperature inside actuator	°C	
i64	Highest temperature inside actuator [°C]	°C	
i00	Exit information level		

1) The mA unit is represented in the display by the icon .

16.14.2 Operating level

Code	Parameters	Display/select (select ESC to cancel)	Section
Start screen			
0/1	Depending on application	► Read only	Start-up and configuration
Operating level			
1	Positioning value	► Read only	Start-up and configuration
2	Operating mode	AUTO (automatic mode) MAN (manual mode)	
3 ¹⁾	Positioning value (manual mode)	0.0 to 100.0 %	
4	Reading direction	DISP, dSID	
5	Start initialization	> INI	
6	Application	POSI (positioner) PID (PID controller) 2STP (two-step mode) 3STP (three-step mode) POSF (temperature closed-loop control upon input signal failure)	
8	Fast configuration level	IN, OUT, DIR	
9	Key number	> KEY	
10	Activate the configuration level	> CO	
11	Activate the information level	> INF	
20	Activate the service level	> SER	
23	Activate the communication level	> COM	
Fatal error (can only be seen when error exists)			
EF	Final test failed	ENDT	Malfunctions
E00	Error: No initialization performed	RUNT	
E01	Error: Input signal failure	FAIL	
E02	Error: Blockage	BLOC	
E03	Error: Both limit switches are active	SWI	
E04	Error: Canceled while retracting stem	SIN	
E05	Error: Canceled while extending stem	SOUT	
E06	Error: Motor or potentiometer not turning	MOT	
E08	Plausibility error	PLAU	
E09	Bus failure	BUS	

Annex A (configuration instructions)

Code	Parameters	Display/select (select ESC to cancel)	Section
EEPROM error (can only be seen when error exists)			
E11	Error: No basic setting	NTRV	Malfunctions
E12	Error: No configuration	NCO	
E13	Error: No calibration	NCAL	
E14	Error: No potentiometer calibration	NPOT	
E15	Error: No transit time	NRUN	

¹⁾ Only in manual mode (MAN)

16.14.3 Service level

Code	Parameters	Display/selection (select ESC to cancel)	Section
Information – Actuator			
d01	Firmware version	► Read only	Markings on the device
d02	Revision number	► Read only	
Errors – Status			
d10	Malfunctions	► Read only	Malfunctions
d11	Priority position triggered	YES NO	
Errors – Fatal errors			
d20	No initialization performed	► Read only YES NO	Malfunctions
d21	Input signal failure		
d22	Blockage		
d23	Both limit contacts active		
d24	Canceled while retracting stem		
d25	Canceled while extending stem		
d26	Motor or potentiometer not turning		
d26	Sensor failure		

Code	Parameters	Display/selection (select ESC to cancel)	Section
Error – EEPROM error			
d31	EEPROM error: Basic setting	▶ Read only E RD (read error) E WR (write error)	Malfunctions
d32	EEPROM error: Configuration		
d35	EEPROM error: Calibration		
d36	EEPROM error: Potentiometer calibration		
d41	EEPROM error: Serial number		
d42	EEPROM error: Manufacturing parameters	▶ Read only E RD (read error) E WR (write error)	
d43	EEPROM error: Transit time		
d44	EEPROM error: Status messages		
d45	EEPROM error: Statistics		
Test – Actions			
d51	Start zero calibration	ZER	Start-up and configuration
d52	Start initialization	INI	
d53	Perform reset	RES	
d54	Load default settings in actuator	DEF	
d55	Testing the display	TEST (all segments displayed)	
Test – Transit time			
d61	Start transit time measurement	RUN	Start-up and configuration
d62	Measured transit time	▶ Read only in s	
d63	Measured travel	▶ Read only in mm	
d00	Exit level	> ESC	

**Tip**

Other parameters of the service level can viewed in the TROVIS-VIEW software.

16.14.4 Communication level

Code	Parameters	Display/select (select ESC to cancel)	Section
Serial interface			
A51	Communication	ENAB (enabled) DISA (disabled)	
Interface module			
A61	Communication	ENAB (enabled) DISA (disabled)	
A62	Interface module	485 (RS-485) USB (USB) ETH (Ethernet) NONE (none)	
A63	Protocol	AUTO (automatic: SSP, Modbus) MODX (Modbus, adjustable)	
Modbus interface module			
A64	Station address	1 to 247	
A65	Baud rate (in Baud)	1200 2400 4800 9600 192 (19200)	
A66	Stop bits and parity	1SNP (1 stop bit, no parity) 1SEP (1 stop bit, even parity) 1SOP (1 stop bit, odd parity) 2SNP (2 stop bits, no parity)	
A67	Bus failure monitoring in min (timeout)	0 to 99	
A00	Exit level	> ESC	

16.14.5 Configuration level

Code	Parameters	Setting range (select ESC to cancel)	WE	Section	Customer-specific data
Input signal					
c01	Source	mA (current signal) V (voltage signal) C (Pt-1000) VIA (via interface)	mA	Start-up and configuration	
c02	Lower range value	0.0 to 15.0 mA	4.0 mA		
		0.0 to 7.5 V	2.0 V		
c03	Upper range value	5.0 to 20.0 mA	20.0 mA		
		2.5 to 10.0 V	10.0 V		
c04	Logic	0: Inverted; 1: Not inverted	1		
Position feedback signal					
c05	Unit	mA (current signal) V (voltage signal)	mA	Start-up and configuration	
c06	Lower range value	0.0 to 15.0 mA	4.0 mA		
		0 to 7.5 V			
c07	Upper range value	5.0 to 20.0 mA	20.0 mA		
		2.5 to 10.0 V			
Binary input					
c11	Function	NONE (inactive) PRIO (priority position) NEXT (next entry in information level) LAMP (backlight activated) MEND (exit manual level for travel adjustment)	NONE	Start-up and configuration	
c12	Logic	NINV (not inverted) INV (inverted)	NINV		

Annex A (configuration instructions)

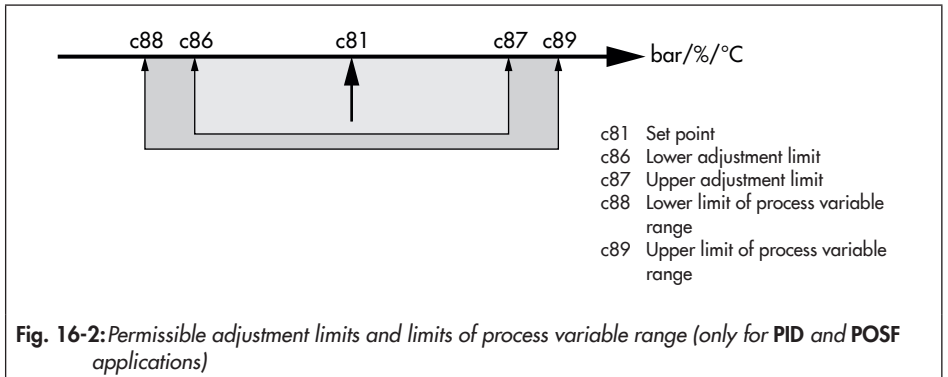
Code	Parameters	Setting range (select ESC to cancel)	WE	Section	Customer-specific data
Binary output					
c15	Function	NONE (inactive) FAIL (indicate error during operation) LIM (electronic limit contact) PRIO (priority position reached) BIN (adopt binary input) MAN (indicate manual mode)	NONE	Start-up and configuration	
c16	Logic	NINV (not inverted) INV (inverted)	NINV		
Electronic limit contact (binary output)					
c21	Message in case of event	NONE (inactive) HIGH (value above limit) LOW (value below limit)	NONE	Start-up and configuration	
c22	Switching point	0.0 to 100.0 %	10.0 %		
c23	Hysteresis	0.0 to 10.0 %	1.0 %		
Electronic limit contact 1					
c24	Message in case of event	NONE (inactive) HIGH (value above limit) LOW (value below limit)	NONE	Start-up and configuration	
c25	Switching point	0.0 to 100.0 %	10.0 %		
c26	Hysteresis	0.0 to 10.0 %	1.0 %		
Electronic limit contact 2					
c27	Message	NONE (inactive) HIGH (value above limit) LOW (value below limit)	NONE	Start-up and configuration	
c28	Switching point	0.0 to 100.0 %	90.0 %		
c29	Hysteresis	0.0 to 10.0 %	1.0 %		

Code	Parameters	Setting range (select ESC to cancel)	WE	Section	Customer-specific data
Input signal					
c31	Detect input signal failure	NO YES	NO	Start-up and configuration	
c32	Positioning value upon input signal failure	INT (internal positioning value) LAST (last position)	INT		
c33	Internal positioning value	0.0 to 100.0 %	0.0 %		
c34	Travel for priority position	0.0 to 100.0 %	0.0 %		
c35	End position guiding (stem retracts)	50.0 to 100.0 %	97.0 %		
c36	End position guiding (stem extends)	0.0 to 49.9 %	1.0 %		
c37	Superimposing an error message	YES (error reading active) NO (error reading inactive)	NO		
Operation					
c42	Direction of action	>> (increasing/increasing) << (increasing/decreasing)	>>	Start-up and configuration	
c43	Restart	NORM (normal) ZERO (zero calibration) FIX (fixed positioning value) STOP (stop in manual level)	NORM		
c44	Fixed positioning value for restart	0.0 to 100.0 %	0.0 %		
Blockage					
c51	Blockage detection	NO (function inactive) YES (function active)	NO	Start-up and configuration	
c52	Blockage removal	NO (function inactive) YES (function active)	NO		
c53	Blocking protection of valve	NO (function inactive) YES (function active)	NO		

Annex A (configuration instructions)

Code	Parameters	Setting range (select ESC to cancel)	WE	Section	Customer-specific data
Travel					
c61	Rated travel	► Read only	mm	Start-up and configuration	–
c63	Limited travel range	10.0 to 100.0 %	100.0 %		–
c65	Stroking speed	► Read only	mm/s		–
c66	Transit time	► Read only	s		–
c67	Dead band (switching range)	0.5 to 5.0 %	2.0 %		
Characteristic					
c71	Characteristic type	LIN (linear) EQUA (equal percentage) INV (reverse equal percentage) USER (user-defined)	LIN	Start-up and configuration	
c72	User-defined characteristic	User-defined			
PID controller					
c80	Operating point Y_0	0 to 100 %	0 %	Start-up and configuration	
c81	Set point	0.0 to 100.0 %	50.0 %		
c82	Proportional-action coefficient K_p	0.1 to 50.0	1.0		
c83	Reset time T_N	0 to 999 s	20 s		
c84	Derivative-action time T_V	0 to 999 s	0 s		
Scaling of the set point for PID controller					
c85	Unit	NONE (none) PER (%) CEL (°C) BAR (bar)	PER		
c86	Lower range value	–999 to 999	0		
c87	Upper range value	–999 to 999	100		
Process variable adjustment					
c88	Lower limit of range	Depending on c85 (see above)	0		
c89	Upper limit of range	Depending on c85 (see above)	100		

Code	Parameters	Setting range (select ESC to cancel)	WE	Section	Customer-specific data
Error signal					
c90	Function	0: Not inverted; 1: Inverted	0		
Actuator					
c91	Customized key number active	NO YES	NO	Start-up and configuration	
c92	Customized key number	0000 to 1999	0000		
c93	Backlight always on	NO YES	NO		
c94	Key number is active	NO YES	NO		



Annex A (configuration instructions)

Characteristic level

Code	Parameters	Selection	WE	Section	Customer-specific data
H0	X0	0.0 to 100.0 %	0.0 %	Start-up and configuration	
Y0	Y0	0.0 to 100.0 %	0.0 %		
H1	X1	0.0 to 100.0 %	10.0 %		
Y1	Y1	0.0 to 100.0 %	10.0 %		
H2	X2	0.0 to 100.0 %	20.0 %		
Y2	Y2	0.0 to 100.0 %	20.0 %		
H3	X3	0.0 to 100.0 %	30.0 %		
Y3	Y3	0.0 to 100.0 %	30.0 %		
H4	X4	0.0 to 100.0 %	40.0 %		
Y4	Y4	0.0 to 100.0 %	40.0 %		
H5	X5	0.0 to 100.0 %	50.0 %		
Y5	Y5	0.0 to 100.0 %	50.0 %		
H6	X6	0.0 to 100.0 %	60.0 %		
Y6	Y6	0.0 to 100.0 %	60.0 %		
H7	X7	0.0 to 100.0 %	70.0 %		
Y7	Y7	0.0 to 100.0 %	70.0 %		
H8	X8	0.0 to 100.0 %	80.0 %		
Y8	Y8	0.0 to 100.0 %	80.0 %		
H9	X9	0.0 to 100.0 %	90.0 %		
Y9	Y9	0.0 to 100.0 %	90.0 %		
H10	X10	0.0 to 100.0 %	100.0 %		
Y10	Y10	0.0 to 100.0 %	100.0 %		
H00	Exit level				

16.15 Further codes on the display

Code	Function	State	Text
F11	Zero calibration	Active	ZERO
F12	Initialization	Active	INIT
F13	Transit time measurement	Active	RUN
F41	Blocking protection	Active	BPRO
F42	Blockage removal	Active	BREM
F61	Retract actuator stem in manual level	Active	MIN
F63	Extend actuator stem in manual level	Active	MOUT
F64	Stop actuator stem in manual level	Active	MSTO

16.16 Excerpt from Modbus data point list

The electric actuator in firmware version 3.10 and higher can be fitted with an RS-485 module to use the Modbus RTU protocol. This protocol is a master/slave protocol. In this case, a control station is the master and the electric actuator the slave, for example.

The following Modbus functions are supported:

Code	Modbus function	Application
1	Read Coils	Read state of several digital outputs in bit format
3	Read Holding Registers	Read several parameters
5	Write Single Coil	Write a single digital output in bit format
6	Write Single Register	Write a value into a single holding register
15	Write Multiple Coils	Write several digital outputs in bit format
16	Write Multiple Registers	Write a value into several holding registers

The electric actuator can issue the following Modbus error responses:

Annex A (configuration instructions)

Error code	Error	Cause
1	Illegal function	The function code is not supported.
2	Illegal data address	A register address is invalid or write-protected
3	Illegal data value	A value contained in the data is not allowed or not plausible.
4	Slave device failure	An unrecoverable error occurred during an action.
6	Slave device busy	The slave is busy and cannot accept the query.

Several important data points from the Modbus data point list are listed below. The entire data point list is available on request.

i Note

Data are saved in a non-volatile EEPROM. This type of memory has a limited life of at least 100,000 write operations per memory address. It is almost impossible to exceed this limitation if configurations and data are only changed manually using TROVIS-VIEW or at the device. If parameters are changed automatically (e.g. by Modbus communication), make sure to observe the maximum number of write operations and take appropriate action to prevent that parameters are written too frequently.

HR	Designation	Access	Transmission range		Indicating range	
			Start	End	Start	End
Actuator version						
1	Device type (3374 or 3375)	R	3374	3375	3374	3375
2	Reserved					
3	Revision	R	300	9999	3.00	99.99
4	Part one of serial number (top four digits)	R	0	9999	0	9999
5	Part two of serial number (bottom four digits)	R	0	9999	0	9999
6	Firmware version	R	100	9999	1.00	99.99
7	Released firmware version	R	0	1	0	1
8	Modbus station address	R	0	255	0	255
9	Gear version	R	0	2	0	2
Control						
10	Application	R	0	4	0	4
11	Direction of action	R	0	1	0	1

HR	Designation	Access	Transmission range		Indicating range	
			Start	End	Start	End
Inputs (operating values) for positioner application						
12	Positioning value in %	R/W	0	1000	0	100.0
13	Input signal in mA or in V	R	0	2400	0	24.0
14	Unit of input signal	R	0	1	0	1
Inputs (operating values) for PID controller application						
15	Process variable in unit (PID controller)	R	-10000	10000	-1000	1000
16	Set point in unit (PID controller)	R	-10000	10000	-1000	1000
17	Unit (PID controller)	R	0	3	0	3
Operating values (outputs)						
18	Travel in %	R	0	1000	0	100.0
19	Travel in mm	R	0	1000	0	100
20	Set point deviation of positioner in % (positioning value/travel)	R	-1000	1000	0	100
21	Set point deviation of PID controller in % (set point/process variable)	R	-1000	1000	0	100
Operating values (position feedback)						
22	Position feedback in %	R	0	1000	0	100.0
23	Position feedback in mA/V	R	0	240	0	24.0
24	Unit of position feedback	R	0	1	0	1
Manual level of control station						
25	Manual positioning value in manual level of control station in %	R/W	0	1000	0	100.0
26	Set point deviation of manual level (control station) in %	R	-1000	1000	-100.0	100.0
27	Positioning value (manual level on site) in %	R	0	1000	0	100.0
28	Status of positioning value	R	0	5	0	5
Additional input values						
29	Input IN1 in °C (only with PID application in version 3.12 and higher)	R	-500	1500	-50.0	150.0
30	Input IN2 in °C (only with PID application in version 3.12 and higher)	R	-500	1500	-50.0	150.0

Annex A (configuration instructions)


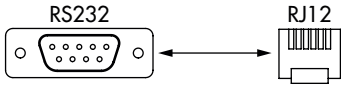

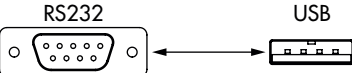
Binary operating data

CL	Designation COILS (1-bit)	Access	Status 0	Status 1
Operating states				
1	Malfunctions	R	No	Yes
2	Maintenance demanded	R	No	Yes
3	Manual level on site active	R	No	Yes
4	Enable manual level of control station (travel adjustment)	R/W *H	No	Yes
Binary input				
5	Binary input status	R	Off	On
6	Binary input (switching contact)	R	Off	On
Limits				
7	State of electronic limit contact 1	R	Off	On
8	State of electronic limit contact 2	R	Off	On
9	Electronic limit contacts exist	R	Off	On
Limit contact				
10	Torque switch: Actuator stem retracted	R	Off	On
11	Torque switch: Actuator stem extended	R	Off	On
Binary output				
12	Logical state of binary output	R	Off	On
13	Binary output (switching contact)	R	Off	On
14	Enable manual level of control station (binary output)	R/W	No	Yes
15	Logical state of binary output (manual level of control station)	R/W	Off	On
Fatal error				
16	Final test failed	R	No	Yes
17	Plausibility error	R	No	Yes
18	Motor or potentiometer not turning	R	No	Yes
19	Both limit contacts are active	R	No	Yes
20	Retracting of actuator stem canceled	R	No	Yes
21	Extending of actuator stem canceled	R	No	Yes
22	Blockage	R	No	Yes
23	Input signal failure	R	No	Yes
24	Sensor failure	R	No	Yes

CL	Designation COILS (1-bit)	Access	Status 0	Status 1
EEPROM error				
25	Basic setting: state	R	No	Yes
26	Basic setting: cause	R	Read error	Write error
27	Settings: state	R	No	Yes
28	Settings: cause	R	Read error	Write error
29	Calibration: state	R	No	Yes
30	Calibration: cause	R	Read error	Write error
31	Potentiometer calibration: state	R	No	Yes
32	Potentiometer calibration: cause	R	Read error	Write error
33	Serial number: state	R	No	Yes
34	Serial number: cause	R	Read error	Write error
35	Manufacturing parameter: state	R	No	Yes
36	Manufacturing parameter: cause	R	Read error	Write error
37	Transit time: state	R	No	Yes
38	Transit time: cause	R	Read error	Write error
39	Status messages: state	R	No	Yes
40	Status messages: cause	R	Read error	Write error
41	Statistics: state	R	No	Yes
42	Statistics: cause	R	Read error	Write error
Functions				
43	Zero calibration active	R	No	Yes
44	Initialization active	R	No	Yes
45	Blocking protection active	R	No	Yes
46	Blockage removal active	R	No	Yes
States				
48	Active controller (only application: temperature closed-loop control upon input signal failure)	R	No	Yes
49	Excessive temperature inside the actuator	R	No	Yes
50	Priority position active	R	No	Yes
51	No initialization performed	R	No	Yes

17 Annex B

17.1 Parts for retrofitting and accessories

Parts for retrofitting	
Mechanical limit contacts	Order no. 1402-0898
Electronic limit contacts	Order no. 1402-0591
RS-485 module	Order no. 1402-1522
Accessories	
Hardware package consisting of: <ul style="list-style-type: none"> - Memory pen-64 - Connecting cable - Modular adapter 	Order no. 1400-9998
Memory pen-64	Order no. 1400-9753 
Connecting cable	Order no. 1400-7699 
Modular adapter	Order no. 1400-7698 
USB to RS232 adapter	Order no. 8812-2001 
TROVIS-VIEW software (free of charge)	▶ www.samsongroup.com > Service & Support > Downloads > TROVIS-VIEW

17.2 After-sales service

Contact SAMSON's After-sales Service for support concerning service or repair work or when malfunctions or defects arise.

E-mail address

You can reach our after-sales service at aftersalesservice@samsongroup.com.

Addresses of SAMSON AG and its subsidiaries

The addresses of SAMSON, its subsidiaries, representatives and service facilities worldwide can be found on our website ( www.samsongroup.com) or in all SAMSON product catalogs.

Required specifications

Please submit the following details:

- Type
- Configuration ID
- Serial number
- Firmware version

Service key number	1732
Customized key number	

EB 8332-2 EN



SAMSON AKTIENGESELLSCHAFT
Weismüllerstraße 3 · 60314 Frankfurt am Main, Germany
Phone: +49 69 4009-0 · Fax: +49 69 4009-1507
samson@samsongroup.com · www.samsongroup.com