

Automation System TROVIS 5100 District Heating Controller TROVIS 5179



Mounting and Operating Instructions

EB 5179 EN

Firmware version 1.2x
Edition August 2005

Disclaimer of liability

We are constantly developing our products and therefore, reserve the right to change the product or the information contained in this document at any time without notice.

We do not assume any liability for the accuracy or completeness of these mounting and operating instructions. Moreover, we do not guarantee that the buyer can use the product for an intended purpose. SAMSON rejects any liability for claims by the buyer, especially claims for compensation including lost profits or any other financial loss, except the damage was caused intentionally or by gross negligence. If an essential term of the contract is breached by negligence, SAMSON's liability is limited to the foreseeable damage.

Safety instructions



- ▶ The device may only be assembled, started up or operated by trained and experienced personnel familiar with the product. Proper shipping and appropriate storage are assumed.
- ▶ The controller has been designed for use in electrical power systems. For wiring and maintenance, you are required to observe the relevant safety regulations.

Contents

1	Operation	6
1.1	Operating elements	6
1.1.1	Operating keys	6
1.1.2	Operating switches	7
1.2	Operating modes	8
1.3	Display	9
1.4	Displaying data	10
1.5	Setting the controller time	11
1.6	Setting the times-of-use	13
1.6.1	Copying the times-of-use	15
1.6.2	Entering public holidays	16
1.6.3	Entering vacation periods	18
2	Start-up	20
2.1	Setting the system code number	20
2.2	Activating and deactivating functions	21
2.3	Changing parameters	23
2.3.1	Enter key number	24
2.4	Configuring universal inputs	24
2.5	Calibrating sensors	24
2.6	Resetting to default values	26
3	Manual operation	27
4	Systems	28
5	Functions of the heating circuit	38
5.1	Functioning principle	38
5.2	Weather-compensated control	38
5.2.1	Gradient characteristic	39
5.2.2	4-point characteristic	39
5.3	Fixed set point control	41
5.4	Differential temperature control using variable weighting factors	41
5.5	Deactivation depending on outdoor temperature	42
5.5.1	OT deactivation value in rated operation	42
5.5.2	OT deactivation value in reduced operation	42
5.5.3	OT activation value in rated operation	43
5.5.4	Summer mode	43
5.6	Delayed outdoor temperature adaptation	44
5.7	Outdoor temperature-dependent advance heating	44

5.8	Remote operation	45
5.9	Optimization with room sensor	45
5.10	Flash adaptation	47
5.11	Adaptation	47
5.12	Room temperature-dependent control	48
5.13	Pump management	49
5.14	Releasing the heating circuit	50
5.15	Position feedback in pre-control circuit	50
6	Functions of the DHW circuit.	51
6.1	DHW heating in the storage tank charging system	51
6.2	DHW heating in the storage tank system	53
6.3	Priority operation	55
6.3.1	Reverse control	55
6.3.2	Set-back operation	56
6.4	Forced charging of the DHW storage tank	56
6.5	Thermal disinfection of the DHW storage tank	56
7	System-wide functions	58
7.1	Automatic summer time/winter time changeover	58
7.2	Frost protection	58
7.3	Forced operation of the pumps	58
7.4	Return flow temperature limitation	58
7.5	Condensate accumulation control	60
7.6	Compensating for time delays	60
7.7	Three-step control	61
7.8	On/off control	62
7.9	Continuous-action control	62
7.10	Forwarding the outdoor temperature	63
7.11	Flow rate/capacity limitation over a pulse input.	63
7.12	Locking manual level	65
8	Operational faults	66
8.1	Error list/sensor failure	66
8.2	Collective error alarm	67
8.3	Temperature monitoring	69
8.4	Monitoring the input terminals for limit violations	70
8.5	Error status register	71

8.6	Error alarms	72
8.6.1	Sending text message in case of a fault alarm	73
8.6.2	Sending fax in case of a fault alarm	73
9	Communication	75
9.1	RS-232-C system bus interface	76
9.2	RS-232/RS-485 system bus interface (for four-wire bus) in combination with cable converters	77
9.3	Description of communication parameters to be adjusted	78
9.4	Meter bus interface	80
9.4.1	Activating the meter bus	80
9.4.2	Flow rate/capacity limitation using meter bus	81
9.5	LON communication.	83
9.6	Requesting/processing an external demand	84
9.7	Sending outdoor temperatures and controller time	85
10	Installation	87
11	Electrical connection.	89
12	Appendix.	96
12.1	Function block lists.	96
12.2	Parameter list	107
12.3	Display	121
12.4	Sensor resistance tables	128
12.5	Technical data	129
12.6	Customer data	130

1 Operation

The controller is ready for use with the temperatures and operating schedules preset by the manufacturer.

On start-up, the **current time and date** need to be set at the controller (-> section 1.5).

1.1 Operating elements

The operating controls are located in the front panel of the controller and protected by a Plexiglas door.

1.1.1 Operating keys



Changeover key

Press to switch between operating level and configuration/parameter level



Reset key

Press to reset accessible parameters to their default settings; the controller must be in the parameter level



Arrow keys

- To scroll within levels
- To change values



Enter key

- To access levels
- Access parameters and functions to edit them
- Confirm settings
- Display set points in info level

1.1.2 Operating switches

Heating circuit mode selector switch

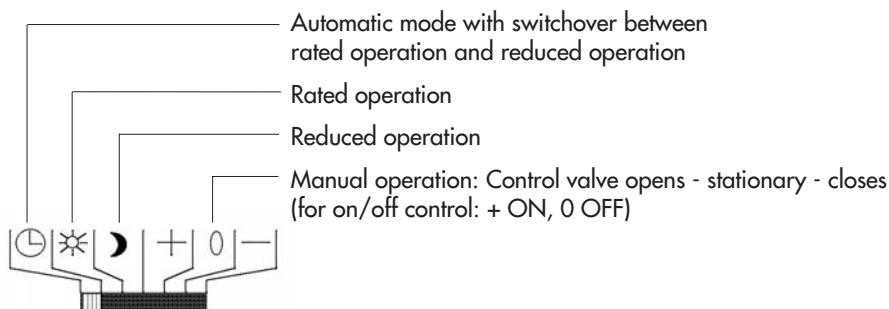

DHW circuit mode selector switch

The operating mode icon stickers are included in the scope of delivery and can be stuck on the front above the mode selector switch for control circuit 2 (middle), if required.

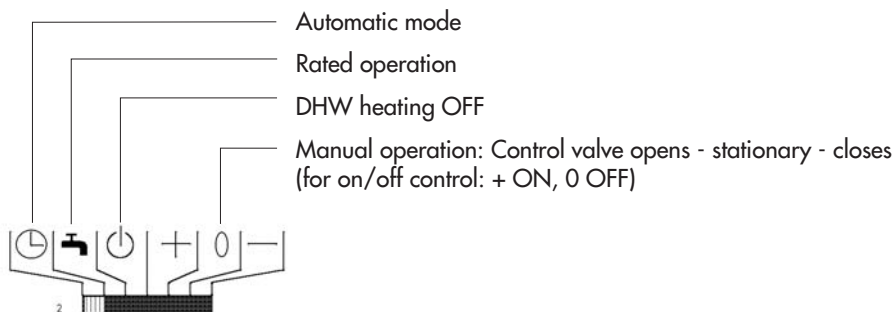

Note!

In manual mode, **frost protection** is not guaranteed.

The assignment of the control circuits to the mode selector switches depends on the system code number (AnI):

System (AnI)	Mode selector switch		
	Top	Middle	Bottom
1	Heating circuit 1	Heating circuit 2	Pre-control circuit
2	Heating circuit 1	DHW heating	Heating circuit 2
3	Heating circuit 1	Heating circuit 2	Heating circuit 3/Pre-control circuit
4	Heating circuit 1	DHW heating	Pre-control circuit
5	Heating circuit 1	DHW heating	Heating circuit 2/Pre-control circuit
6	Heating circuit 1	Heating circuit 2	Heating circuit 3
7	Heating circuit 1	DHW heating	Pre-control circuit
8	Heating circuit 1	DHW heating	Heating circuit 2/Pre-control circuit
9	Heating circuit 1	DHW heating	Heating circuit 2
10	Heating circuit 1	DHW heating	Heating circuit 2

1.2 Operating modes

Day mode (rated operation) ☀

Regardless of the programmed times-of-use and summer mode, the set points relevant for rated operation are used by the controller.

Night mode (reduced operation) 🌙

Regardless of the programmed times-of-use, the set points relevant for reduced operation are used by the controller.

Automatic mode ⚙

During the programmed times-of-use, the controller works in rated operation. Outside these times-of-use, the controller is in reduced operation, unless control operation is deactivated depending on the outdoor temperature. The controller switches automatically between both operating modes.

Manual operation+ 0 –

Valves and pumps can be controlled manually.

1.3 Display

During operation, the display indicates the current time as well as information about the operation of the controller. The times-of-use are represented by black squares below the row of numbers at the top of the display. Icons indicate the operating status of the controller.

The controller status can be displayed in the operating level (InF level) (-> section 1.4).

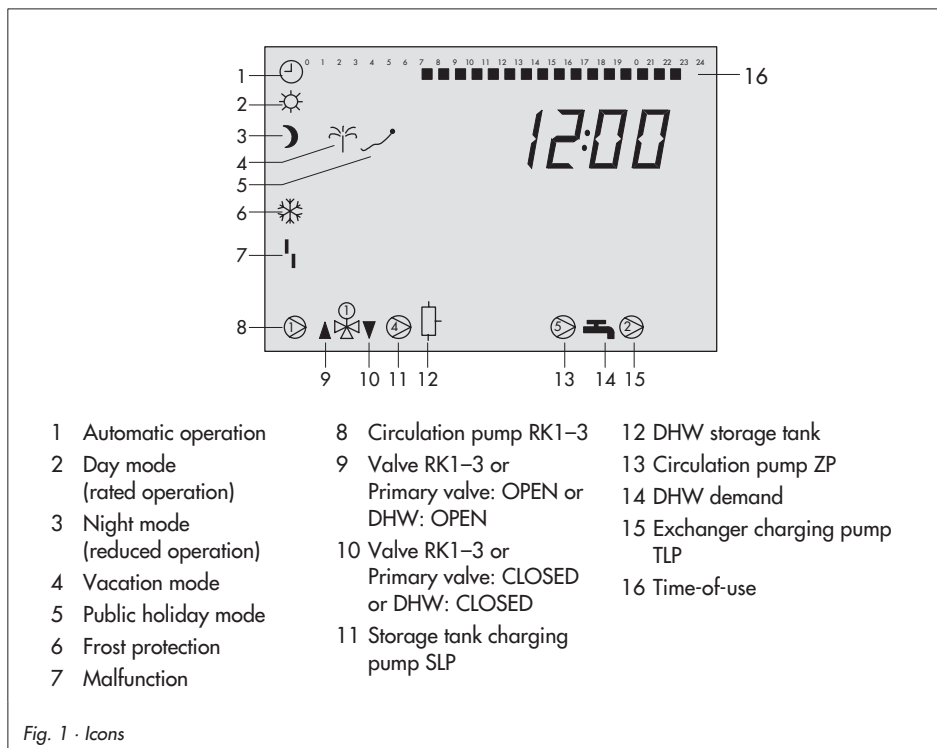

Fig. 1 - Icons

1.4 Displaying data

Measured values, set points, times-of-use, public holidays and vacation periods can be retrieved and displayed in the **InF1** to **InF9** information levels. The various displays are listed in section 11.4.

- ▶ InF1: Heating circuit 1
- ▶ InF2: Heating circuit 2
- ▶ InF3: Heating circuit 3
- ▶ InF4: DHW heating
- ▶ InF5: Primary control circuit
- ▶ InF6: Does not exist
- ▶ InF7: LON communication
- ▶ InF8: Error status register/sensor failure
- ▶ InF9: Communication
- ▶ PU: Pumps, manual level
- ▶ bln-E: Binary inputs and outputs
- ▶ Error: Alarms

Proceed as follows:

- ⏴ Select information level (→ Fig. 10 on page 141).
- ⊗ Confirm information level.
- ⏴ Select value you want to change.
- ⊗ Compare the set point/limit value and the actual value.
- ⏴ ⏵ Press keys simultaneously:
to switch to the operating level.

1.5 Setting the controller time

The current time and date need to be set immediately after start-up and after a power failure lasting longer than 24 hours.

Proceed as follows:

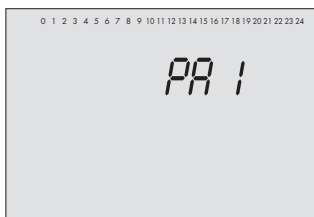

- ↔ Switch to configuration and parameter level.
Display: **PA1**

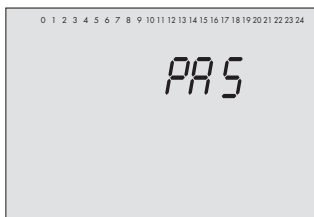

- ⏴ Select PA5 parameter level.

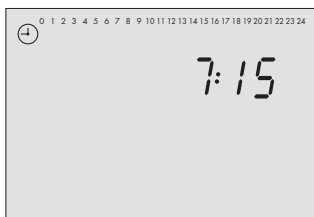





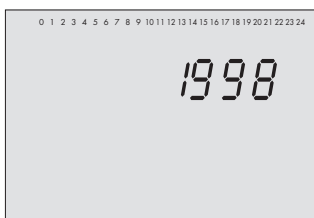

- ⊗ Open PA5 parameter level.
Display: Controller time
- ⊗ Activate editing mode for the controller time
☼ blinks.
- ⏴ Change controller time.



- ⊗ Confirm controller time.
Display: Date (day.month)
- ⊗ Activate editing mode for the controller date.
- ⏴ Change date setting.





-  Confirm date.
Display: Year.
-  Activate editing mode for the controller year.
-  Change year setting.
-  Confirm year.
-  Exit PA5 parameter level.
-  Return to the operating level.

Note!

The controller automatically returns to the operating level if the keys are left unpressed for two minutes.

1.6 Setting the times-of-use

Two times-of-use can be set for each day of the week. If just one time-of-use is required, the start and stop times of the second time-of-use must be programmed to identical times. The time schedules for the three heating circuits, DHW heating and the circulation pump can be read over Modbus. Pump circuits are treated as mixer circuits.



Time schedule	Parameter level	Icon
Heating circuit 1 to 3	PA1 to PA3	
DHW heating	PA4	
Circulation pump	PA4	

Parameters	WE*	Range of values
Period/day	1-7	1-7, 1, 2, 3, 4, 5, 6, 7 with 1-7 = every day, 1 = Monday, 2 = Tuesday, ..., 7 = Sunday
Start first time-of-use	07:00	0:00 to 24:00h; in steps of 30 minutes
Stop first time-of-use	12:00	0:00 to 24:00h; in steps of 30 minutes
Start second time-of-use	12:00	0:00 to 24:00h; in steps of 30 minutes
Stop second time-of-use	22:00	0:00 to 24:00h; in steps of 30 minutes

* Default settings (WE) valid for heating circuits 1 to 3

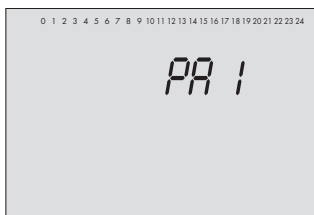
Proceed as follows:



-  Switch to configuration and parameter level.
Display: **PA1**
-  Select parameter level.
-  Open parameter level.

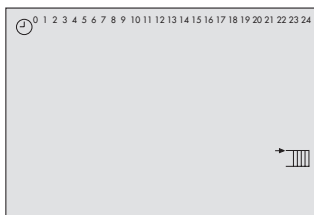

-  Select datapoint for times-of-use.



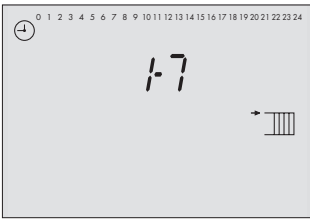

- ⊗ Activate editing mode for times-of-use.
Display: **1-7**

- ⏴ Select period/day for which the times-of-use are to be valid:
1-7 = every day,
1 = Monday, 2 = Tuesday, ..., 7 = Sunday

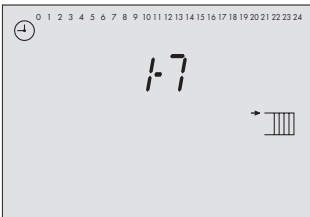

- ⊗ Activate editing mode for period/day.
Display shows: **START**; ⊕ blinks

- ⏴ Edit start time (steps of 30 minutes).

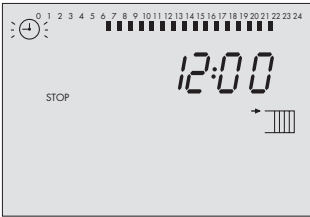

- ⊗ Confirm start time. Display shows: **STOP**

- ⏴ Edit stop time (steps of 30 minutes).

- ⊗ Confirm stop time.
Display shows: **START**
The second time-of-use is set like the first time-of-use.

To set the times-of-use for each day, repeat the instructions in the fields highlighted in gray.

- ⏴ Select **End** on the display.
- ⊗ Exit the datapoint for times-of-use.
- ⏴⏵ Exit the parameter level.
- ⏴ Return to the operating level.

Note!

Do not use the 1-7 datapoints to check the programmed times-of-use. Otherwise, the times-of-use are reset to their default settings.

Note!

The controller automatically returns to the operating level if the keys are left unpressed for two minutes.

1.6.1 Copying the times-of-use

The times-of-use of heating circuit 1 (2) can be copied and used for heating circuit 2 (3).

Copy function	Parameter level	Icon
HK1 → HK2	PA1	COPY2
HK2 → HK3	PA2	COPY3

Proceed as follows:

- ⇒ Switch to configuration and parameter level.
Display: **PA1**
- ⏴ Select parameter level.
- ⊗ Open parameter level.
- ⊗ Select "COPY_" data point.
Open copy program.
The display blinks.
- ⊗ Copy the times-of-use.
- ⏴ Select **End** on the display.
- ⊗ Exit the parameter level.
- ⇒ Return to the operating level.

1.6.2 Entering public holidays

On public holidays, the times-of-use specified for Sunday apply. A maximum of 20 public holidays may be entered.

Parameters	WE	Level / Range of values
Public holidays f. heating circuit 1	–	PA1 / 01.01 to 31.12
Public holidays f. heating circuit 2	–	PA2 / 01.01 to 31.12
Public holidays f. heating circuit 3	–	PA3 / 01.01 to 31.12

Note!

The programmed public holidays and vacations of any heating circuit (HK1, HK2 or HK3) apply with the setting Co4 -> Fb12 = ON, **select 1, 2 or 3** also for the DHW heating.

Proceed as follows:

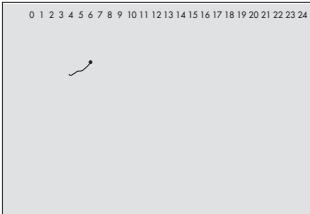

- ↻ Switch to configuration and parameter level.
Display: **PA1**
- ⏴ Select parameter level.
- ⊗ Open parameter level.
- ⏴ Select datapoint for public holidays.
Display shows:
- ⊗ Open data point for public holidays.
- ⏴ If applicable, select ----.
- ⊗ Activate editing mode for public holiday.
 blinks.
- ⏴ Edit public holiday
- ⊗ Confirm public holiday.

To enter additional public holidays, re-select ---- (between 31.12 and 01.01) and repeat the steps in the fields highlighted in gray.

- ⏴ ⏵ Exit the parameter level.
- ↻ Return to the operating level.

Note!

Public holidays that are not assigned to a specific date should be deleted by the end of the year so that they are not carried on into the following year.

Deleting a public holiday:

- Select the holiday you wish to delete in the datapoint for public holidays.
 - Confirm selection.
 - Select - - - - .
 - Delete the public holiday.
-

Note!

The controller automatically returns to the operating level if the keys are left unpressed for two minutes.

1.6.3 Entering vacation periods

During vacation periods, the controller constantly remains in the reduced operating mode. The system is monitored for frost. A maximum of 10 vacation periods can be entered.

Parameters	WE	Level / Range of values
Vacation period for heating circuit 1	–	PA1 / 01.01 to 31.12
Vacation period for heating circuit 2	–	PA2 / 01.01 to 31.12
Vacation period for heating circuit 3	–	PA3 / 01.01 to 31.12

Note!

The programmed public holidays and vacations of any heating circuit (HK1, HK2 or HK3) apply with the setting Co4 -> Fb12 = ON, **select 1, 2 or 3** also for the DHW heating.

Proceed as follows:

- ⇒ Switch to configuration and parameter level.
Display: **PA1**
- ⏴ Select parameter level.
- ⊗ Open parameter level.
- ⏴ Select datapoint for vacation periods.
Display shows: 🌸
- ⊗ Open datapoint for vacation periods.
Display shows: **START**
- ⏴ If applicable, select - - - -.
- ⊗ Activate editing mode for vacation periods.
🌸 blinks.
- ⏴ Set start date of vacation period.
- ⊗ Confirm start date of the vacation period.
Display shows: **STOP**
- ⏴ Set end of vacation period.
- ⊗ Confirm end of the vacation period.

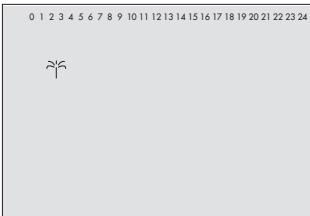

To enter additional vacation periods, re-select - - - - (between 31.12 and 01.01) and repeat the steps in the fields highlighted in gray.

⏴ ⏵ Exit the parameter level.

⇒ Return to the operating level.

Note!

Vacation periods that are not assigned to a specific date should be deleted by the end of the year so that they are not carried on into the following year.

Deleting vacation periods:

- Select the vacation period you wish to delete in the datapoint for vacation periods.
 - Confirm selection.
 - Select - - - - .
 - Delete vacation period.
-

Note!

The controller automatically returns to the operating level if the keys are left unpressed for two minutes.

2 Start-up

2.1 Setting the system code number

10 different hydraulic schematics are available. Each system configuration is represented by a system code number. The different schematics are dealt with in section 4. Available controller functions are described in sections 5, 6 and 7.

Changing the system code number resets previously adjusted function blocks to their default settings (WE).

The system code number is set in the configuration level.

Proceed as follows:

- ⇨ Switch to configuration and parameter level.
Display shows: **PA1**
 - ↓ Select **Anl_** on the display.
 - ⊗ Activate editing mode for the system code number.
Anl blinks on the display.
 - ↓ Edit system code number.
 - ⊗ Confirm system code number.
Display shows: **Co1**
 - ⇨ Return to the operating level.
-

Note!

The controller automatically returns to the operating level if the keys are left unpressed for two minutes.

2.2 Activating and deactivating functions

A function is activated or deactivated in the associated function block. The numbers 0 to 24 in the top row of the display represent the respective function block numbers. When a configuration level is opened, the activated function blocks are indicated by a black square on the right-hand side below the function block number. For more details on function blocks, refer to section 12.1.

The functions are grouped by topics:

- ▶ Co1: Heating circuit 1
- ▶ Co2: Heating circuit 2
- ▶ Co3: Heating circuit 3
- ▶ Co4: DHW heating
- ▶ Co5: System-wide functions
- ▶ Co6: Sensor initialization
- ▶ Co7: LON communication
- ▶ Co8: Error initialization
- ▶ Co9: Communication

Proceed as follows:

- ⇒ Switch to configuration and parameter level.
Display shows: **PA1**
- ↓ Select configuration level.
- ⊗ Open configuration level.
- ↓ Select function block.
- ⊗ Activate editing mode for the function block.
Fb_ blinks on the display.
If **0000** appears on the display, the key number needs to be entered first. Refer to section 2.3.1
- ↑ Activate the function block (Fb = ON).
An activated function block is indicated by a black square below (right) the function block number in the top row of the controller display.
or:
- ↓ Deactivate the function block (Fb = OFF).



- ✕ Confirm settings.
If the function block is not closed, further function block parameters can be adjusted.
Proceed as follows:
Make the desired changes and confirm.
If applicable, the next function block parameter is displayed.
Confirm all parameters to exit the opened function block.

To adjust additional function blocks, repeat the steps in the fields highlighted in gray.

⬆️⬇️ Exit configuration level.

⬅️ Return to the operating level.

Note!

The controller automatically returns to the operating level if the keys are left unpressed for two minutes.

2.3 Changing parameters

Depending on the set system code number and the activated functions, not all parameters listed in the parameter list in the Appendix (-> section 12.2) might be available.

The parameters are grouped by topics:

- ▶ PA1: Heating circuit 1
- ▶ PA2: Heating circuit 2
- ▶ PA3: Heating circuit 3
- ▶ PA4: DHW heating
- ▶ PA5: System-wide parameters
- ▶ PA6: Does not exist
- ▶ PA7: LON communication
- ▶ PA8: Does not exist
- ▶ PA9: Communication

Proceed as follows:

- ↻ Switch to configuration and parameter level.
Display shows: **PA1**
- ⏴ Select parameter level.
- ⊗ Open parameter level.
- ⏴ Select parameter.
- ⊗ Activate editing mode for the parameter.
- ⏴ Edit the parameter.
- ⊗ Confirm the parameter setting.

To adjust additional parameters, repeat the steps in the fields highlighted in gray.

- ⏴ ⏵ Exit parameter level.
- ↻ Return to the operating level.

Note!

The controller automatically returns to the operating level if the keys are left unpressed for two minutes.

2.3.1 Enter key number

Some functions are protected against unintentional or unauthorized access. These functions can only be activated or deactivated after the valid key number has been entered. The valid key number for initial start-up can be found on page 137. To avoid unauthorized use of the key number, remove the page or make the key number unreadable.

Proceed as follows:

0 0 0 0 blinks on the display.

- ☑ Set valid key number.
- ☒ Confirm key number.
When the correct key number is entered, the function block that is to be changed blinks on the display.
On entering an incorrect key number, the controllers switches to the next configuration level.

The key number remains active for approx. 10 minutes.

2.4 Configuring universal inputs

The connected sensors are calibrated in Co6 configuration level.

The following applies:

- ▶ Co6 -> Fb00 = ON: Pt 100/Pt 1000 sensors (default setting)
- ▶ Co6 -> Fb00 = OFF: Pt 100/PTC sensors

The resistance values of the sensors can be found on page 128.

Each universal input can be configured separately.

The following inputs Ni 200/1000, PTC, NTC, Pt 100/1000, (0/4...20) mA, (0–10 V) can be configured as function block parameters.

The function blocks 01 to 17 correspond to the binary inputs BE1 to BE17 in the terminal wiring plan (page 92 onwards).

The function block for the required sensor is activated and the function block parameter selected which corresponds to the type of input signal.

2.5 Calibrating sensors

If the temperature values displayed at the controller differ from the actual temperatures, the measured values of all connected sensors can be changed or readjusted. To calibrate a sensor, the currently displayed sensor value must be changed such that it matches the temperature (ref-

erence temperature) measured directly at the point of measurement. Sensor calibration is to be activated in Co6 via function block Fb23.

Proceed as follows:

- ⇒ Switch to configuration and parameter level.
Display shows: **PA1**
 - ↓ Select Co6 level.
 - ⊗ Open Co6 level. Display shows: **Fb00**
 - ↓ Select function block Fb23.
 - ⊗ Confirm selection. Display shows: **0 0 0 0**
Enter and confirm key number.
Fb23 blinks on the display.
 - ⊗ Activate editing mode for function block.
 - ↑ Activate function block.
 - ⊗ Start sensor calibration.
 - ↓ Select the function block for the sensor that you want to calibrate:
The function blocks Fb01 to Fb17 correspond to the inputs in the terminal wiring plan (page 92 onwards) e.g. Fb02 = BE2
 - ⊗ Activate editing mode for function block.
Fb_ blinks on the display.
 - ⊗ Display measured value.
 - ⊗ Activate editing mode for measured value.
Measured value blinks on the display.
 - ↓ Correct measured temperature. Read the actual temperature directly from the thermometer at the point of measurement and enter this value as the reference temperature.
 - ⊗ Confirm corrected measured temperature.
- Additional sensors are calibrated similarly.
- ↓ Select **End**.
 - ⊗ Exit configuration level.
 - ⇒ Return to the operating level.

Note!

*The sensor values adjusted are not reset by the **Loading default settings** function.*

2.6 Resetting to default values

All parameters and function blocks from any parameter level can be reset to their default settings (WE).

Proceed as follows:

- * Reset to default settings.
Function blocks and parameters are reset to their default settings (WE).
-

Note!

When the key number is active, the function blocks protected by the key number are also reset to their default settings.

The controller is ready for operation with its default settings. You just need to set the correct date and current time.

3 Manual operation

Switch to manual mode to configure all outputs (see wiring diagram in section 11).

Proceed as follows:

- Position all selector mode switches to **+**, **0** or **-**.
- ⏴ Select **PU** pump manual level.
 - ⊗ Open pump manual level.
 - ⏴ Select pump PU1 to PU5:
 - PU1: BA11
 - PU2: BA12
 - PU3: BA13
 - PU4: BA14
 - PU5: BA15
 - ⊗ Confirm pump selection.
The display blinks.
 - Activate output: ⏴
 - Deactivate output: ⏴
 - ⊗ Confirm setting.
The modified values remain active as long as the controller is in manual mode.
Move slide switch from **0**, **+** or **-**.
 - ⏴⏴ Exit manual level.
-

Note!

*In manual mode, **frost protection** is not guaranteed.*

4 Systems

There are 10 hydraulic schematics.

System code number (Anl)	1	2	3	4	5	6	7	8	9	10
Heating	Outdoor temperature compensated flow temperature control with variable return flow temperature limitation									
Number of heating circuits	2	2	3	1	2	3	1	2	2	2
No. of heating circuits w. mixing valve	2	2	2	1	1	3	1	1	2	2
DHW heating		•		•	•		•	•	•	•
From the primary circuit							•	•	•	
From the secondary circuit		•		•	•					•

System Anl 1

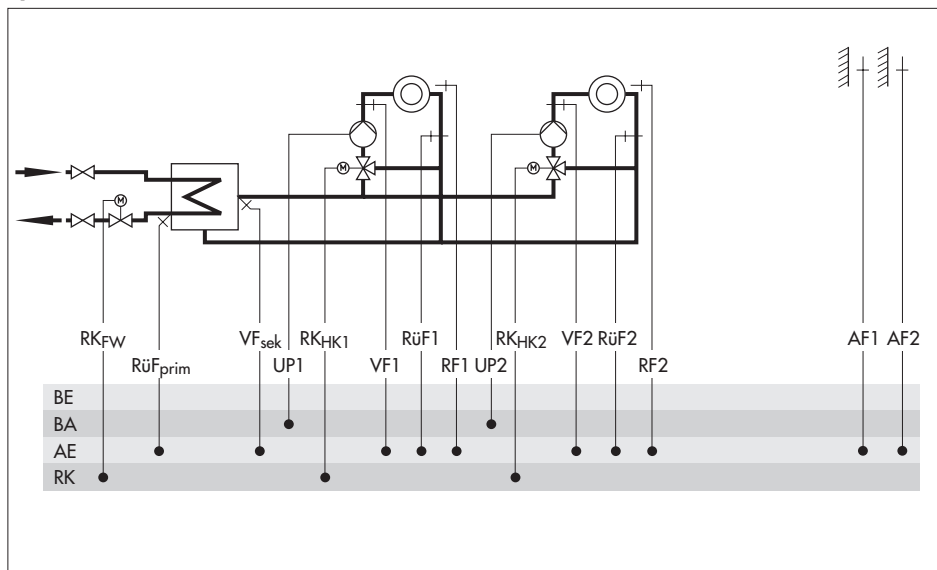

Default setting		
Co1 -> Fb00		= OFF (without RF1)
Co1 -> Fb01		= OFF (without RüF1)
Co1 -> Fb02		= ON (with AF1)
Co2 -> Fb00		= OFF (without RF2)
Co2 -> Fb01		= OFF (without RüF2)
Co2 -> Fb02		= OFF (without AF2)
Co5 -> Fb00		= ON (with VFsek)
Co5 -> Fb01		= ON (with RüFprim)

System Anl 2

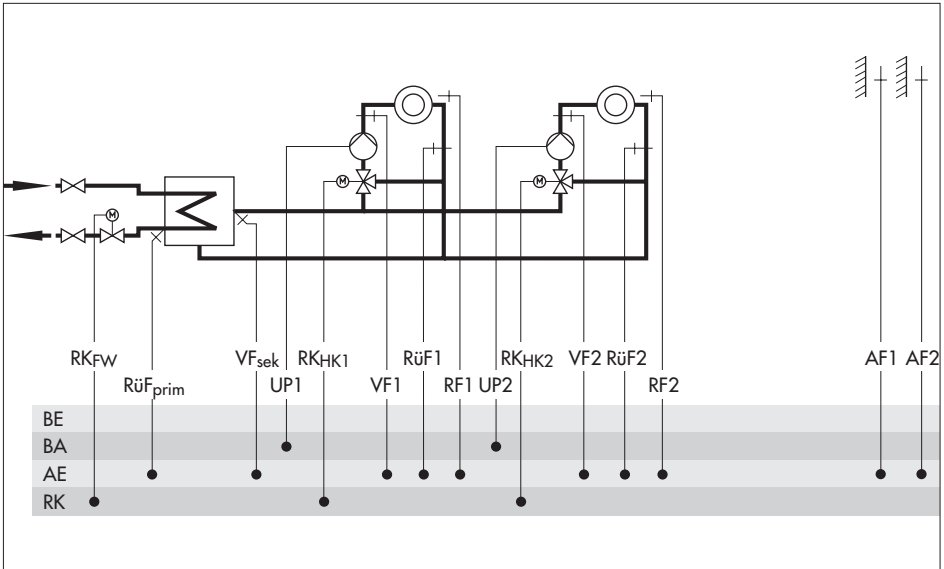

Default setting		
Co1 -> Fb00		= OFF (without RF1)
Co1 -> Fb01		= OFF (without RüF1)
Co1 -> Fb02		= ON (with AF1)
Co2 -> Fb00		= OFF (without RF2)
Co2 -> Fb01		= OFF (without RüF2)
Co2 -> Fb02		= OFF (without AF2)
Co4 -> Fb00		= ON (with SF1)
Co4 -> Fb01		= ON (with SF2)
Co4 -> Fb03		= ON (with VFS, with VFT)
Co5 -> Fb00		= ON (with VFsek)
Co5 -> Fb01		= ON (with RüFprim)

System Anl 3

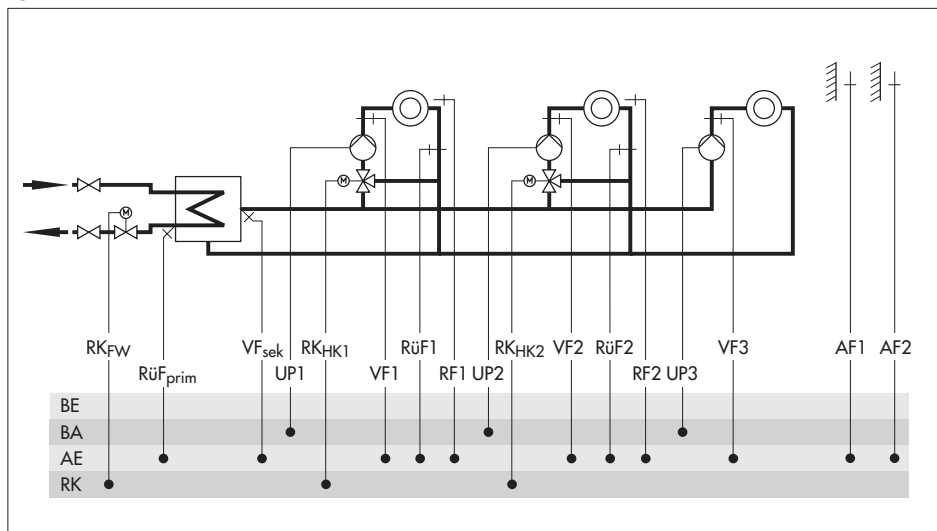

Default setting		
Co1 -> Fb00		= OFF (without RF1)*
Co1 -> Fb01		= OFF (without RüF1)
Co1 -> Fb02		= ON (with AF1)
Co2 -> Fb00		= OFF (without RF2)*
Co2 -> Fb01		= OFF (without RüF2)
Co2 -> Fb02		= OFF (without AF2)
Co5 -> Fb00		= ON (with VFsek)
Co5 -> Fb01		= ON (with RüFprim)

* Only for optimization and temperature reading

System Anl 4

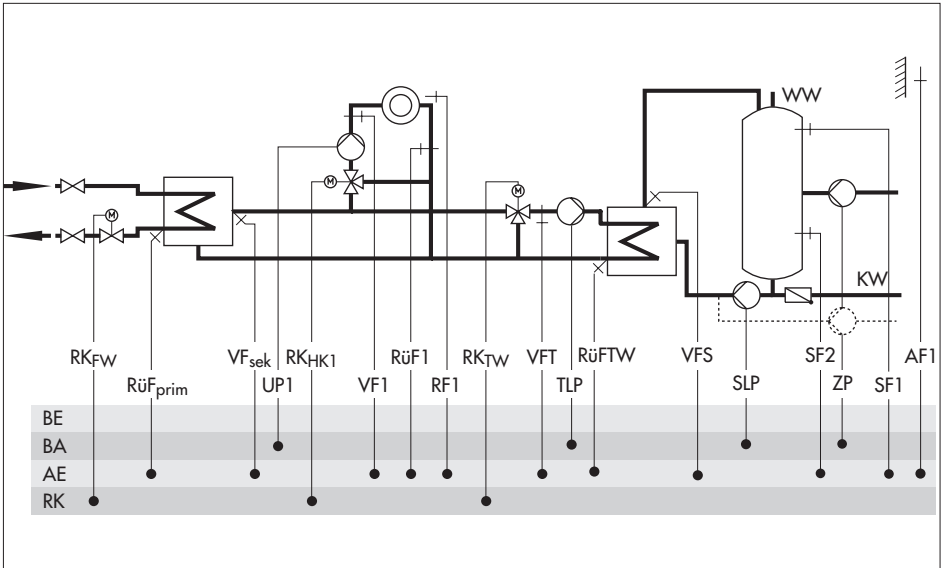

Default setting		
Co1 -> Fb00		= OFF (without RF1)
Co1 -> Fb01		= OFF (without RüF1)
Co1 -> Fb02		= ON (with AF1)
Co4 -> Fb00		= ON (with SF1)
Co4 -> Fb01		= ON (with SF2)
Co4 -> Fb02		= OFF (without RüFTW)
Co4 -> Fb03		= ON (with VFS, with VFT)
Co5 -> Fb00		= ON (with VFsek)
Co5 -> Fb01		= ON (with RüFprim)

Set Co4 -> Fb11 = ON if the instrumentation represented by the broken line is required.

System Anl 5

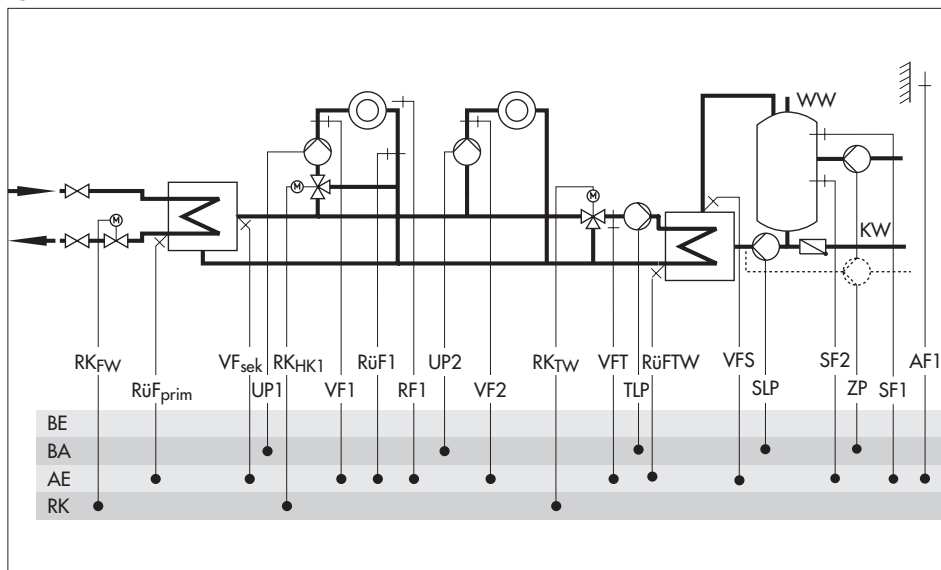

Default setting	
Co1 -> Fb00	= OFF (without RF1)*
Co1 -> Fb01	= OFF (without RüF1)
Co1 -> Fb02	= ON (with AF1)
Co4 -> Fb00	= ON (with SF1)
Co4 -> Fb01	= ON (with SF2)
Co4 -> Fb02	= OFF (without RüFTW)
Co4 -> Fb03	= ON (with VFS, with VFT)
Co5 -> Fb00	= ON (with VFsek)
Co5 -> Fb01	= ON (with RüFprim)

* Only for optimization and temperature reading

Set Co4 -> Fb11 = ON if the instrumentation represented by the broken line is required.

System Anl 6

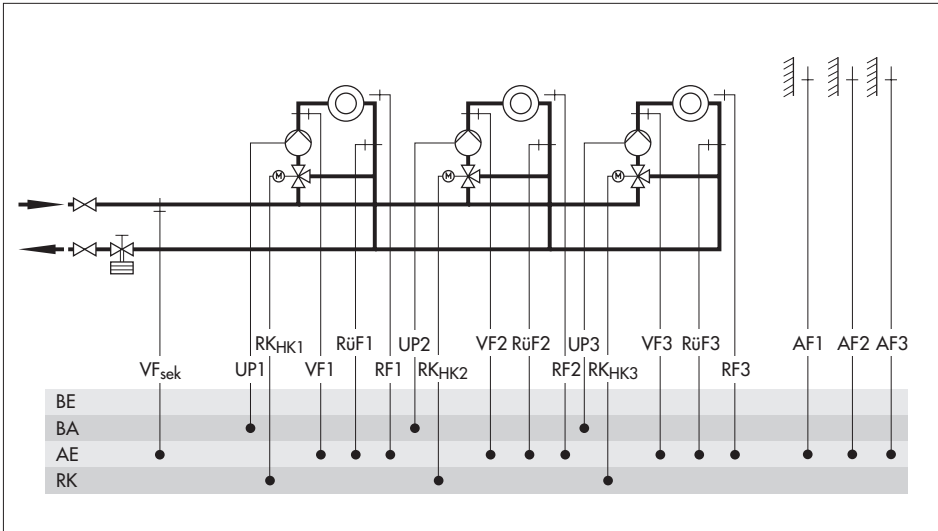

Default setting		
Co1 -> Fb00		= OFF (without RF1)
Co1 -> Fb01		= OFF (without RüF1)
Co1 -> Fb02		= ON (with AF1)
Co2 -> Fb00		= OFF (without RF2)
Co2 -> Fb01		= OFF (without RüF2)
Co2 -> Fb02		= OFF (without AF2)
Co3 -> Fb00		= OFF (without RF3)
Co3 -> Fb01		= OFF (without RüF3)
Co3 -> Fb02		= OFF (without AF3)
Co5 -> Fb00		= ON (with VFsek)

System Anl 7

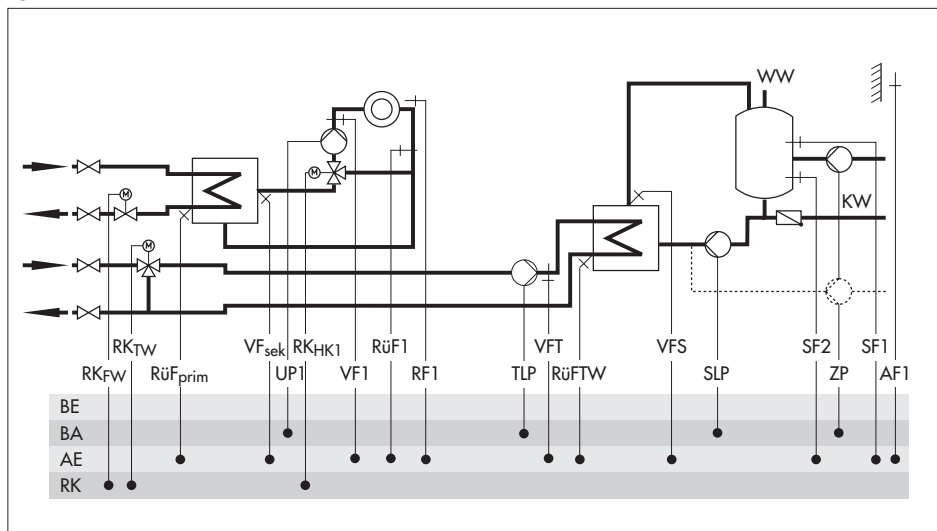

Default setting

Co1 -> Fb00	= OFF (without RF1)
Co1 -> Fb01	= OFF (without RUF1)
Co1 -> Fb02	= ON (with AF1)
Co4 -> Fb00	= ON (with SF1)
Co4 -> Fb01	= ON (with SF2)
Co4 -> Fb02	= OFF (without RUF1)
Co4 -> Fb03	= ON (with VFS, with VFT)
Co5 -> Fb00	= ON (with VFsek)
Co5 -> Fb01	= ON (with RUFprim)

Set Co4 -> Fb11 = ON if the instrumentation represented by the broken line is required.

System Anl 9

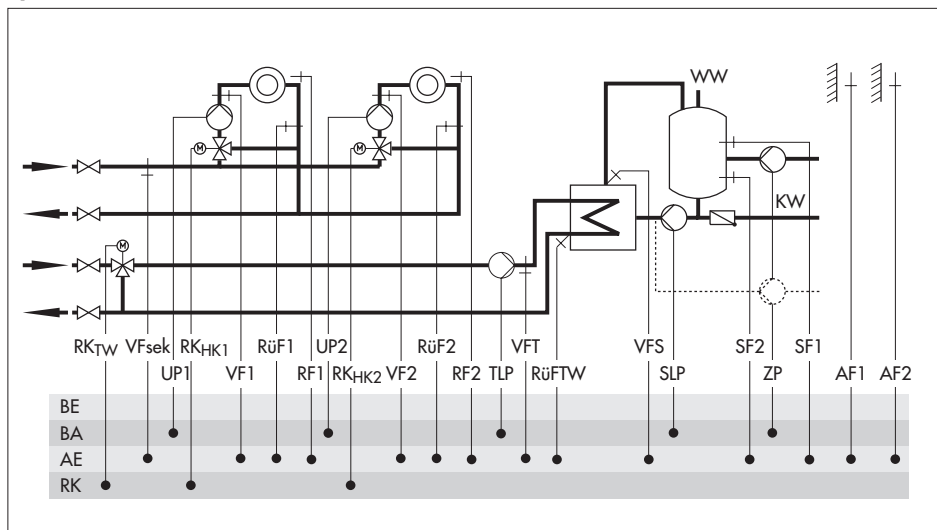

Default setting	
Co1 -> Fb00	= OFF (without RF1)
Co1 -> Fb01	= OFF (without RüF1)
Co1 -> Fb02	= ON (with AF1)
Co2 -> Fb00	= OFF (without RF2)
Co2 -> Fb01	= OFF (without RüF2)
Co2 -> Fb02	= OFF (without AF2)
Co4 -> Fb00	= ON (with SF1)
Co4 -> Fb01	= ON (with SF2)
Co4 -> Fb02	= OFF (without RüFTW)
Co4 -> Fb03	= ON (with VFS, with VFT)
Co5 -> Fb00	= ON (with VFsek)

Set Co4 -> Fb11 = ON if the instrumentation represented by the broken line is required.

System Anl 10

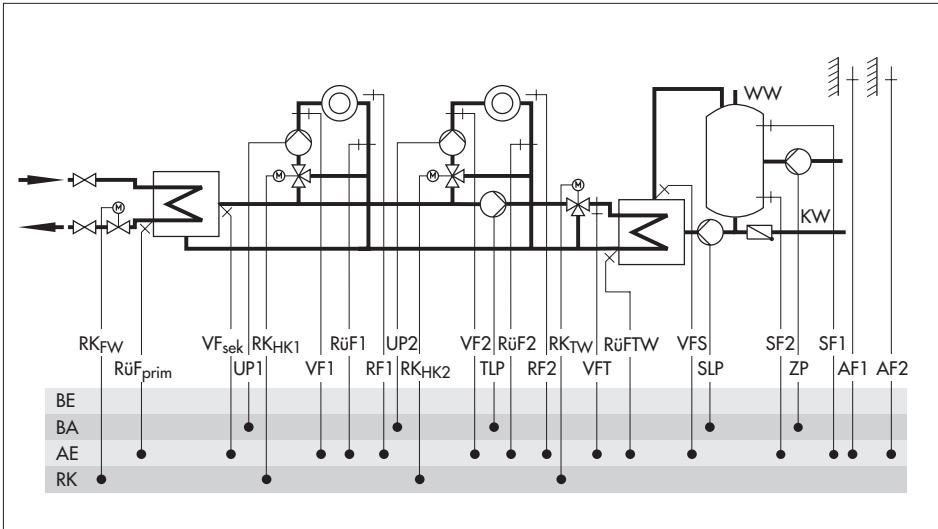

Default setting		
Co1 -> Fb00		= OFF (without RF1)
Co1 -> Fb01		= OFF (without RüF1)
Co1 -> Fb02		= ON (with AF1)
Co2 -> Fb00		= OFF (without RF2)
Co2 -> Fb01		= OFF (without RüF2)
Co2 -> Fb02		= OFF (without AF2)
Co4 -> Fb00		= ON (with SF1)
Co4 -> Fb01		= ON (with SF2)
Co4 -> Fb02		= OFF (without RüFTW)
Co4 -> Fb03		= ON (with VFS, with VFT)
Co5 -> Fb00		= ON (with VFsek)
Co5 -> Fb01		= ON (with RüFprim)

5 Functions of the heating circuit

Which controller functions are available depends on the selected system code number (AnI).

5.1 Functioning principle

The heating circuit with the highest flow set point has priority. This principle applies to all heating circuits with mixing valves. In systems AnI 3, 5 and 8, the pump circuit has priority. The flow set point of the heating circuit with priority is controlled by the valve in the pre-control circuit. If several heating circuits have the same flow set point, the heating circuit with lowest number always has priority and is controlled by the primary valve.

5.2 Weather-compensated control

When weather-compensated control is used, the flow temperature is controlled according to the outdoor temperature. The heating characteristic in the controller defines the flow temperature set point as a function of the outdoor temperature (→ Fig. 2).

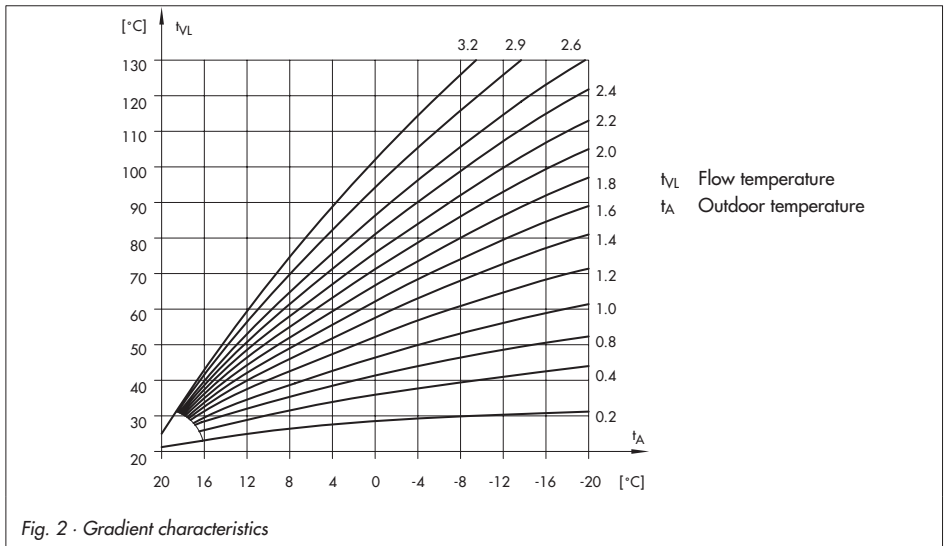

Fig. 2 · Gradient characteristics

Function	WE	Configuration
Outdoor sensor AF1, 2, 3		Co1, 2, 3 → Fb02 = ON* * Co1 → Fb02 cannot be deactivated

If just one outdoor sensor should be connected, connect it to AF1. This outdoor temperature is then used also for HK2 and HK3.

5.2.1 Gradient characteristic

Basically, the following rule applies: a decrease in the outdoor temperature causes the flow temperature to increase. By varying the *Gradient* and *Level* parameters, you can adapt the characteristic to your individual requirements. Increasing *Gradient* results in a higher flow temperature, decreasing *Gradient* in a lower flow temperature. The parameter *Level* performs a parallel transport of the heating characteristic in an upward or downward direction.

Outside the times-of-use, reduced set points are used for control:

Reduced flow set point = *Flow set point* – *Set-back difference*.

The *Max. flow temperature* and *Min. flow temperature* parameters mark the upper and lower limits of the flow temperature. A separate gradient characteristic can be selected for the limitation of the return flow temperature.

Examples for adjusting the characteristic:

- ▶ Old building, radiator design 90/70: Gradient approx. 1.8
- ▶ New building, radiator design 70/55: Gradient approx. 1.4
- ▶ New building, radiator design 55/45: Gradient approx. 1.0
- ▶ Underfloor heating depending on arrangement: Gradient smaller 0.5

Functions	WE	Configuration
4-point characteristic	OFF	Co1, 2, 3 -> Fb10 = OFF
4-point characteristic	OFF	Co5 -> Fb03 = OFF (An1 3, 5, 8 and 10)
Parameters	WE	Parameter level / Range of values
Gradient, flow	1.8	PA1, 2, 3 / 0.4 to 3.2
Level, flow	0 °C	PA1, 2, 3 / -30 to 30 °C
Set-back difference	20 °C	PA1, 2, 3 / 0 to 50 °C
Min. flow temperature	90 °C	PA1, 2, 3 / 20 to 130 °C
Max. flow temperature	20 °C	PA1, 2, 3 / 20 to 130 °C

5.2.2 4-point characteristic

The 4-point characteristic allows you to define your own heating characteristic.

It is defined by 4 points for the *Outdoor temperature*, the *Flow temperature* and the *Return flow temperature*. The *Set-back difference* at points 2 and 3 indicates how much the flow temperature is reduced outside the times-of-use.

The *Max. flow temperature* and *Min. flow temperature* parameters mark the upper and lower limits of the flow temperature.

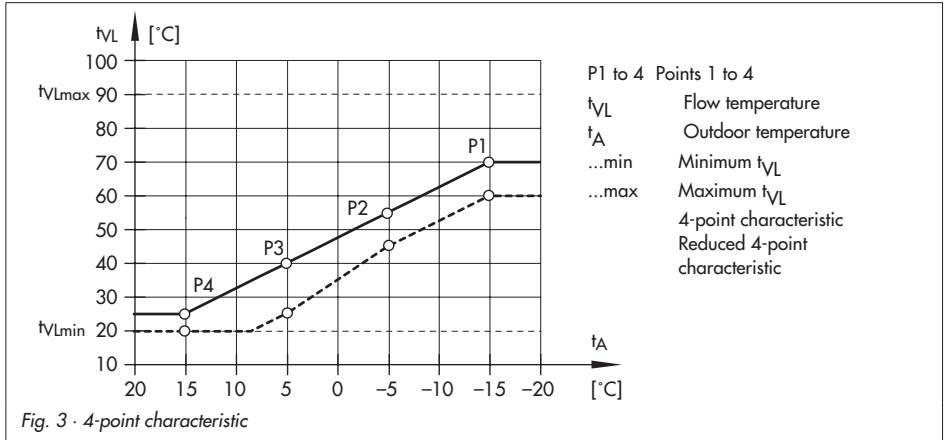

Fig. 3 - 4-point characteristic

Functions		WE	Configuration
4-point characteristic		OFF	Co1, 2, 3 -> Fb10 = ON
4-point characteristic		OFF	Co4 -> Fb03 = ON (Anl 3, 5, 8 and 10)
Parameters		WE	Parameter level / Range of values
Flow temperature	Point 1	70 °C	PA1, 2, 3 / 20 to 130 °C
	Point 2	55 °C	
	Point 3	40 °C	
	Point 4	25 °C	
Outdoor temperature	Point 1	-15 °C	PA1, 2, 3 / -30 to 90 °C
	Point 2	- 5 °C	
	Point 3	5 °C	
	Point 4	15 °C	
Return flow temperature	Point 1	65 °C	PA1, 2, 3 / 20 to 90 °C
	Point 2	50 °C	
	Point 3	35 °C	
	Point 4	20 °C	
Set-back difference	Points 2, 3	20 °C	PA1, 2, 3 / 0 to 50 °C
Max. flow temperature		90 °C	PA1, 2, 3 / 20 to 130 °C
Min. flow temperature		20 °C	PA1, 2, 3 / 20 to 130 °C

Note!

The **4-point characteristic** function can only be activated when the **Adaptation** function is not active (Co1, 2, 3 -> Fb07 = OFF).

5.3 Fixed set point control

During the times-of-use, the flow temperature can be controlled according to a fixed set point. Outside the times-of-use, this set point is reduced by the *Set-back difference*. Both *Minimum flow temperature* and *Maximum flow temperature* parameters are set to identical values.

Parameters	WE	Parameter level / Range of values
Max. flow temperature	90 °C	PA1, 2, 3 / 20 to 130 °C
Min. flow temperature	20 °C	PA1, 2, 3 / 20 to 130 °C
Set-back difference	20 °C	PA1, 2, 3 / 0 to 50 °C

5.4 Differential temperature control using variable weighting factors

This function allows the return flow temperature to be taken into account in addition to the flow temperature. It can only be used in heating circuits with mixing valves.

The difference between the flow and return flow temperature is specified using the *Intended temperature difference* parameter. It is a measure for the energy consumption in a heating circuit. The greater the temperature difference, the larger the energy required by a heating circuit. If the actual temperature difference is not the same as the intended temperature difference, it is evaluated by the *Kp factor for differential temperature control*. After initial signs for a deviation occur, the flow temperature is raised or reduced by this factor.

When the *Kp factor for differential temperature control* is set to 0, the return flow temperature does not have any affect on the control of the flow temperature.

When the *Kp factor for differential temperature control* is set to 1, a pure return flow temperature limitation takes place (-> section 7.4).

The reset time T_N determines how fast the deviation of the temperature difference affects the control circuit (the larger T_N is, the slower the rate in change).

The *Intended temperature difference* parameter is maintained at a constant value by adjusting the speed of the associated circulation pump in the heating circuit. The pump is controlled by an analog 0 to 10 V signal, which is applied to the associated analog output (AA) of the controller (AA1 to AA3). The control signal is displayed in the associated info level. When the differential temperature control without return flow limitation is active, the actual temperature of the return flow is nevertheless displayed. After pressing the enter key, the set point is displayed together with the string "S-r" (for differential temperature control using variable weighting factors).

Function	WE	Configuration
Differential temperature control using variable weighting factors	OFF	Co1, 2, 3 -> Fb18 = ON
	0.5	Proportional gain factor K_p / 0.1 to 999
	200 s	Reset time T_N / 1 to 999 s
	20 °C	Intended temp. difference / 0 to 40 °C
	90 %	Analog value max. / 0 to 100 %
	30 %	Analog value min. / 0 to 100 %
Parameters	WE	Parameter level / Range of values
Max. return flow temperature*	65 °C	PA1, 2, 3 / 20 to 90 °C
Min. return flow temperature*	20 °C	PA1, 2, 3 / 20 to 90 °C
* Can only be selected when Co5 -> Fb01 = ON, select: steig		

Note!

Only one function can be assigned to an analog output (e.g. flow temperature control, passing on the outdoor temperature or differential temperature control).

5.5 Deactivation depending on outdoor temperature

5.5.1 OT deactivation value in rated operation

If the outdoor temperature exceeds the limit *OT deactivation value in rated operation*, the affected heating circuit is put out of service immediately. The valve is closed and the pump is switched off after $t = 2 \times \text{Valve transit time}$. When the outdoor temperature falls below this value (less 0.5 °C hysteresis), heating operation is restarted immediately.

With the default settings, this means that, during the warm season, the system is switched off at an outdoor temperature of 22 °C.

Parameter	WE	Parameter level / Range of values
OT deactivation value in rated operation	22 °C	PA1, 2, 3 / 0 to 90 °C

5.5.2 OT deactivation value in reduced operation

If the outdoor temperature in reduced operation exceeds the limit *OT deactivation value in reduced operation*, the affected heating circuit is put out of service immediately. The valve is closed and the pump is switched off after $t = 2 \times \text{Valve transit time}$.

When the outdoor temperature falls below this value (less 0.5 °C hysteresis), heating operation is restarted immediately.

With the default settings, this means that, at night, the system is switched off at an outdoor temperature of 10 °C to save energy. Nevertheless, remember that the system requires some time in the morning to heat up the building (-> Outdoor temperature-dependent advance heating, section 5.7).

Parameter	WE	Parameter level / Range of values
OT deactivation value in reduced operation	10 °C	PA1, 2, 3 / -10 to 50 °C

5.5.3 OT activation value in rated operation

If a heating circuit is in reduced operation (automatic mode), the circuit is automatically transferred to rated operation when the outdoor temperature falls below the limit *OT activation value in rated operation*. When the limit value is exceeded (plus 0.5 °C hysteresis), reduced operation is restarted.

This function is activated at very low temperatures to avoid the building cooling down excessively outside the times-of-use when low outdoor temperatures occur.

Parameter	WE	Parameter level / Range of values
OT activation value in rated operation	-15 °C	PA1, 2, 3 / -30 to 50 °C

5.5.4 Summer mode

Summer mode is activated depending on the mean daytime temperature (measured between 7.00h and 22.00h) during the desired period.

If the mean daytime temperature exceeds the *Outdoor temperature limit in summer mode* on two consecutive days, summer mode is activated on the following day: the heating is switched off. If the mean daytime temperature remains below the *Outdoor temperature limit in summer mode* on the next day, summer mode is deactivated on the following day.

Functions	WE	Configuration
Summer mode	OFF	Co1, 2, 3 -> Fb11 = ON
	01.06	Start summer mode / 01.01 (1 Jan) to 31.12 (31 Dec)
	30.09	Stop summer mode / 01.01 to 31.12
	18 °C	Outdoor temperature limit in summer mode / 0 to 30 °C

Note!

Summer mode only becomes effective when the controller is in automatic mode (☺).

5.6 Delayed outdoor temperature adaptation

The calculated outdoor temperature is used to determine the flow temperature set point. The heat response is delayed when the outdoor temperature either decreases, or increases and decreases. If the outdoor temperature varies by, for example, 12 °C within a very short period of time, the calculated outdoor temperature is adapted to the actual outdoor temperature in small steps. Assuming a Delay of 3 °C/h, the adaptation would take $t = \frac{12^{\circ}\text{C}}{3^{\circ}\text{C/h}} = 4 \text{ h}$.

Note!

The delayed outdoor temperature adaptation helps avoid unnecessary overloads of central heating stations in combination with either overheated buildings occurring, for example, due to warm winds, or temporarily insufficient heating due to the outdoor sensor being exposed to direct sunshine.

In the operating level, the outdoor temperature blinks on the display while delayed outdoor temperature adaptation is active. The calculated outdoor temperature is displayed.

Function	WE	Configuration
Delayed outdoor temperature adaptation	OFF	Co5 -> Fb04 = ON Ab When outdoor temperature drops Auf Ab When outdoor temperature drops or rises 3 °C/h Delay / 0.2 to 6.0 °C/h

5.7 Outdoor temperature-dependent advance heating

The controller activates the heating depending on the outdoor temperature before the time-of-use starts in normal operation. The *Advance heating time* is based on an outdoor temperature of -12 °C. The advance heating time is shorter when the outdoor temperature is higher.

Functions	WE	Configuration
Optimization	OFF	Co1, 2, 3 -> Fb05 = ON, Select: 1 120 min Advance heating time / 0 to 360 min
Outdoor sensor AF1, 2, 3		Co1, 2, 3 -> Fb02 = ON

5.8 Remote operation

Apart from measuring the room temperature, the Type 5244 Room Sensor (PTC sensor) and Type 5257-5 Room Sensor (Pt 1000 sensor) offer the following options to influence the control process:

- ▶ Selection of the operating mode: Automatic mode · Day mode · Night mode
- ▶ Set point correction: during rated operation, the room temperature set point can be increased or reduced by up to 5 °C using a continuously adjustable rotary knob.

When the room sensor is activated, the measured room temperature is displayed. Nevertheless, it is not used for control unless the **Optimization, Adaptation, Flash adaptation** or **Room temperature-dependent control** functions have been activated.

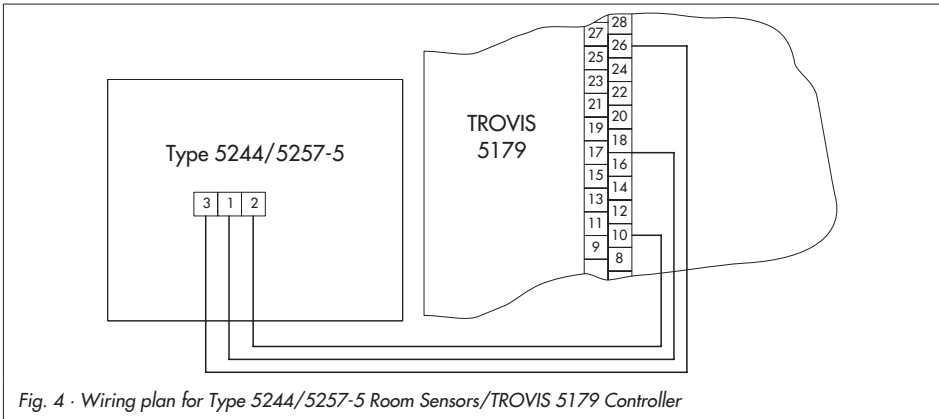

Fig. 4 · Wiring plan for Type 5244/5257-5 Room Sensors/TROVIS 5179 Controller

Function	WE	Configuration
Room sensor RF1, 2, 3	OFF	Co1, 2, 3 -> Fb00 = ON

5.9 Optimization with room sensor

Both the following described functions should only be used when the room (reference room) in which the room sensor is located has a typical heating pattern similar to the rest of the building. In addition, there should be no thermostat valves mounted on the radiators in this reference room.

There are two types of optimization depending on the activation conditions:

▶ **Outdoor temperature-dependent advance heating, room temperature-dependent deactivation**

The controller activates the heating depending on the outdoor temperature before the time-of-use starts in normal operation. The *Advance heating time* is based on an outdoor temperature of $-12\text{ }^{\circ}\text{C}$. The advance heating time is shorter when the outdoor temperature is higher (see section 5.7).

▶ **Room temperature-dependent advance heating and deactivation**

The controller calculates the required advance heating time (max. 6 hours) adapted to the building characteristics, resulting in the *Day set point* (rated room temperature) being reached in the reference room when the time-of-use starts. The heating is heated with the maximum flow temperature during the advance heating phase. As soon as the *Day set point* is reached, weather-compensated control starts.

The controller deactivates the heating in both types of optimization depending on the room sensors up to two hours before the time-of-use finishes. The controller chooses the deactivation time such that the room temperature does not drop significantly below the desired temperature until the time-of-use ends.

During the advance heating period and the premature deactivation of the heating system, the icons ☀ or ☾ blink on the display. Outside the times-of-use, the controller monitors the *Night set point* (reduced room temperature). When the temperature falls below the night set point, the controller heats with the max. flow temperature until the measured room temperature exceeds the adjusted value by $1\text{ }^{\circ}\text{C}$.

Note!

Direct sunshine can cause the room temperature to increase and thus result in the premature deactivation of the heating system.

When the room temperature decreases while the heating system is temporarily outside its times-of-use, this can prematurely cause the controller to heat up to the adjusted Room set point.

Function	WE	Configuration
Room sensor RF1, 2, 3	OFF	Co1, 2, 3 -> Fb00 = ON
Outdoor temperature-dependent advance heating, room temperature-dependent deactivation:		
Optimization	OFF	Co1, 2, 3 -> Fb05 = ON, <i>select: 2</i> 120 min Advance heating time / 0 to 360 min
Outdoor sensor AF1, 2, 3		Co1, 2, 3 -> Fb02 = ON
Room temperature-dependent advance heating and deactivation:		
Optimization	OFF	Co1 to Co3 -> Fb05 = ON, <i>select: 3</i>

Parameters	WE	Parameter level / Range of values
Day set point	20 °C	PA1, 2, 3 / 10 to 90 °C
Night set point	17 °C	PA1, 2, 3 / 10 to 90 °C
Sustained temperature	10 °C	PA1, 2, 3 / 10 to 90 °C

5.10 Flash adaptation

Direct reactions to deviations in room temperature can be achieved using the function block setting: Co1, 2, 3 -> Fb08 = ON.

Flash adaptation counteracts room temperature deviations by increasing or decreasing the flow temperature by up to 30 °C. The shift is displayed under *Level* in PA1, 2, 3 parameter levels; it cannot be altered. The set point correction over remote room panel is not possible.

Note!

Cooling loads, such as drafts or open windows, affect the control process!

Rooms may be temporarily overheated when the cooling load has been eliminated!

Functions	WE	Configuration
Room sensor RF1, 2, 3	OFF	Co1, 2, 3 -> Fb00 = ON
Flash adaptation	OFF	Co1, 2, 3 -> Fb08 = ON

5.11 Adaptation

The controller is capable of automatically adapting the heating characteristic to the building characteristics, provided a gradient characteristic has been set (Co1, 2, 3 -> Fb10 = OFF). The reference room, where the room sensor is located, represents the entire building and is monitored to ensure that the *Day set point* is maintained. When the mean measured room temperature in rated operation deviates from the adjusted set point, the heating characteristic is modified accordingly for the following time-of-use. The corrected value is displayed in PA1, 2, 3 parameter levels under *Gradient, flow*.

Functions	WE	Configuration
Room sensor RF1, 2, 3	OFF	Co1, 2, 3 -> Fb00 = ON
Outdoor sensor AF1, 2, 3		Co1, 2, 3 -> Fb02 = ON
Adaptation	OFF	Co1, 2, 3 -> Fb07 = ON
4-point characteristic	OFF	Co1, 2, 3 -> Fb10 = OFF

Parameter	WE	Parameter level / Range of values
Day set point	20 °C	PA1, 2, 3 / 10 to 90 °C

5.12 Room temperature-dependent control

In systems Anl 6 and 9, the **Room temperature-dependent control** function can be separately activated for each heating circuit. The **Room sensor** function must be activated for this function. Flow and return flow sensors only serve to display the temperature and can therefore be deactivated.

The outdoor sensors are not required for the room control function, but are still required for the **Frost protection** function. The outdoor sensor AF1 can also be deactivated if all the control circuits are configured as room control circuits.

Activation of the room control function causes the control parameters to be automatically set to the following settings:

T_N (reset time) = 1617 s, T_V (derivative-action time) = 330 s, K_P (proportional gain) = 20

With the aid of **Parameter optimization** (Co1, 2, 3 -> Fb16 = ON), these settings are optimized. This, however, requires a constant room temperature at the time when the function is activated and a temperature difference between the current room temperature and the new room set point of at least 3 °C.

In room control circuits, the heating circuit pump is switched on during the advance heating phase.

Note!

A fictive flow set point is reported to master controller in case there is a demand for an externally required signal when the room control function is active. This set point is calculated from the characteristic and outdoor temperature and adapted to the actual demand over adaptation and flash adaptation.

The fictive flow set point has no effect on mixer circuits and blinks on the display. Just the third type of optimization is permitted when the room control is active.



Note! *The frost protection cannot function without an outdoor sensor.*

Functions	WE	Configuration
Room sensor RF1, 2, 3	OFF	Co1, 2, 3 -> Fb00 = ON
Room temperature dependent control	OFF	Co1, 2, 3 -> Fb06 = ON
Parameter optimization	OFF	Co1, 2, 3 -> Fb16
Flow sensor OFF when room temperature dependent control is used	OFF	Co1, 2, 3 -> Fb17

5.13 Pump management

To control the circulation pumps for the heating circuits (UP1 and UP2), reed relay outputs can be used instead of the relay output. Depending on the operating state, the circulation pumps run during the times-of-use regulated depending on the differential pressure. The differential pressure is regulated by the pumps. Outside the times-of-use the circulation pumps are switched back to the minimum speed. The binary outputs BA1 to BA4 have the following function:

- ▶ BA1, BA3: Circulation pump on and off
- ▶ BA2, BA4: Reduce pump speed

If the circulation pump is to be switched on, the contact of BA1 or BA3 is closed. The binary outputs BA2 and BA4 can be configured over the function blocks Co1, 2 -> Fb13.

- ▶ Co1, 2 -> Fb13 = ON: BA2, BA4 = OFF outside the time-of-use
- ▶ Co1, 2 -> Fb13 = OFF: BA2, BA4 = ON outside the time-of-use

Function	WE	Configuration
Pump management	OFF	Co1, 2 -> Fb13

Note!

Refer to the pump manufacturer instructions for the exact terminal assignments of pumps since the terminal assignments vary depending on the pump.

*In systems An1 3, 5, 8 and 10, the pumps of an uncontrolled heating circuit can be switched on and off over an external binary signal. For this purpose, deactivate the **Potentiometer input** function (Co1 to Co3 -> Fb12 = OFF) and select the function block parameter FrG-E.*

5.14 Releasing the heating circuit

The release of the heating circuit in automatic mode is a default setting after the time schedule has been programmed. In addition, it is possible to release the heating circuit over the corresponding potentiometer inputs. When no signal exists at these inputs and the slide switch of the heating circuit is positioned to automatic mode (⊖), the heating circuit is in stand-by mode (i.e. just the frost protection is active).

Function	WE	Configuration
Potentiometer input for release of HK	OFF	Co1, 2, 3 -> Fb12 = OFF FrG-E: Release over binary signal (potentiometer) FrG-A: Release over time schedule with FrG-A: RLG: Configuration as per input FREE: Input freely available

5.15 Position feedback in pre-control circuit

A potentiometer for position feedback (series resistor: 1000 Ω) can be connected at terminal 27 instead of a potentiometer to shift the set point over the room sensor.

The actual position of the valve in the pre-control circuit is issued as an external resistance value.

The valve position is displayed in % of the travel in the operating level at the end of the control circuit data for the pre-control circuit (level 5).

Function	WE	Configuration
Potentiometer in pre-control circuit	OFF	Co5 -> Fb16 = ON

Note!

The potentiometer input HK2 is not available when Co5 -> Fb16 = ON is configured.

6 Functions of the DHW circuit

6.1 DHW heating in the storage tank charging system

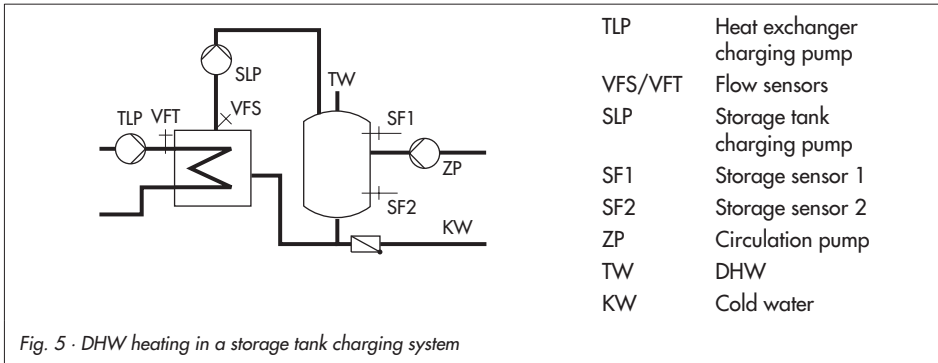

Start storage tank charging

The controller begins charging the storage tank when the water temperature measured at sensor SF1 falls below the *DHW demand ON* by 0.1 °C. If the flow temperature in the system is higher than the required charging temperature, the controller attempts to reduce it in the heating circuit for maximum 3 minutes before the heat exchanger pump together with the storage tank charging pump start to run.

When there is no heating operation or when the flow temperature in the system is lower, the heat exchanger charging pump is switched on immediately. The storage tank charging pump is switched on when the temperature currently measured at storage sensor VFT has reached the temperature measured at sensor SF1.

If a storage tank thermostat is used, the storage tank charging pump is switched on when the temperature $T = \text{Charging temperature} - 5\text{ °C}$ is reached at sensor VFT.

Note!

The charging temperature VFT is regulated by the primary valve in system Anl 2. In systems Anl 4, 5 and 10, the charging temperature VFT is only regulated by the primary valve when the DHW demand has the highest set point and has priority.

In all other systems (Anl 7, 8 and 9) the mixing valve regulates the charging temperature VFT.

When the **Circulation pump** function is active, the circulation pump remains in operation according to the time schedule. The pump is switched off when this function is deactivated.

The **Mixing valve always active** function allows the heat exchanger to maintain the charging temperature using the mixing valve. The heat exchanger charging pump remains switched on and the return flow temperature is not limited outside the times-of-use.

When the **flow sensor VFS** is active, the set point in the heat exchanger charging circuit is affected by the system deviation in the storage tank charging circuit when the storage tank charging pump is switched on:

If the temperature measured at the flow sensor is smaller than the required charging temperature, the set point in the heat exchanger charging circuit is raised by 1 °C every minute.

If the set point in the heat exchanger charging circuit reaches the value in *Maximum charging temperature* parameter, it is not raised any further; an *Err 10* alarm is generated.

Stop storage tank charging

The controller stops charging the storage tank when the water temperature in the storage tank measured at sensor SF2 (*DHW demand OFF*) exceeds the set point by 0.1 °C. The primary valve (Anl 2) or the mixing valve in the DHW circuit are sent pulse signals until the heat exchanger charging temperature on the primary side at sensor VFT has fallen below the *Heat exchanger charging pump deactivation limit*.

The heat exchanger charging pump is switched off according to the time schedule and depending on the temperature. When the flow set point of the primary heating circuit is lower than the *Heat exchanger charging pump deactivation limit*, the heat exchanger charging pump (TLP) is first switched off when the primary heat exchanger charging temperature at sensor VFT has dropped to the same level as the flow set point of the primary heating circuit. The heat exchanger charging pump is switched off at the latest after $t = 2 \times$ Transit time of the primary valve.

The storage tank charging pump (SLP) is switched off after $t = 2 \times$ Transit time of the primary valve or when the storage tank charging temperature in the secondary circuit at sensor VFS has fallen below the *Storage tank charging pump deactivation limit*.

The circulation pump is switched on and off according to a time schedule.

Functions	WE	Configuration
Storage sensor SF1	ON	Co4 -> Fb00 = ON
Storage sensor SF2	ON	Co4 -> Fb01 = ON
Flow sensor VFS	ON	Co4 -> Fb03
Circulation pump	OFF	Co4 -> Fb04
Storage tank system	OFF	Co4 -> Fb10 = OFF
Mixing valve always active	OFF	Co4 -> Fb11

Parameters	WE	Parameter level / Range of values
DHW demand ON	40 °C	PA4 / 20 to 90 °C
DHW demand OFF	45 °C	PA4 / 20 to 90 °C
Charging temperature	55 °C	PA4 / 20 to 90 °C
Heat exchanger charging pump deactivation limit	50 °C	PA4 / 20 to 90 °C
Storage tank charging pump deactivation limit	50 °C	PA4 / 20 to 90 °C
Maximum charging temperature	120 °C	PA4 / 20 to 120 °C

6.2 DHW heating in the storage tank system

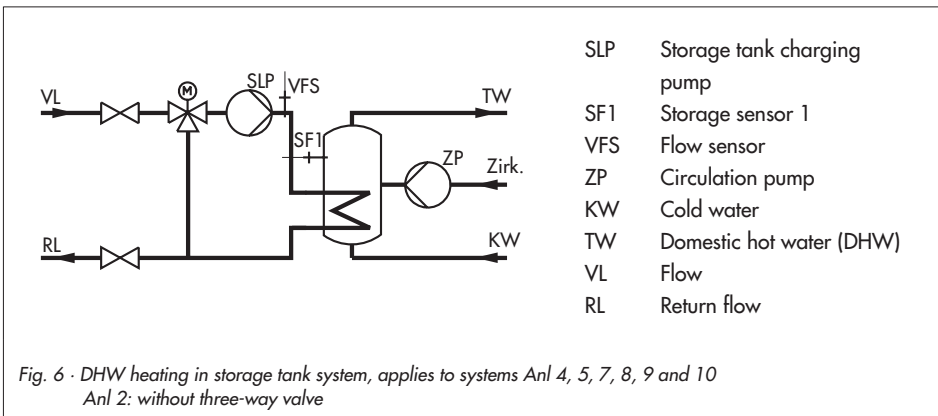

Start storage tank charging

The controller can be reconfigured for all systems with DHW heating to control a DHW storage tank with heating register (storage tank system).

The controller switches the storage tank charging pump (SLP) on and off and controls the mixing valve for the DHW circuit. A mixing valve in the DHW circuit does not exist in system Anl 2. The sensor VFS is connected to terminal 28 and the storage tank charging pump to terminal 45.

The controller starts the storage tank charging when the water temperature measured at sensor SF1 falls below the *DHW demand ON* by 0.1 °C. If the flow temperature in the system is higher than the required charging temperature, the controller attempts to reduce it in the heating circuit for maximum three minutes before the storage tank charging pump starts to run.

When there is no heating operation or when the flow temperature in the system is lower, the storage tank charging pump is switched on immediately.

If a storage tank thermostat is used, the storage tank charging pump is switched on when the temperature $T = \text{Charging temperature} - 5\text{ °C}$ is reached at sensor VFS.

Note!

The charging temperature VFS is controlled in system Anl 2 by the primary valve. In all the other systems (Anl 4, 5, 7, 8, 9 and 10) the mixing valve regulates the charging temperature VFS.

When the **Circulations pump** function is active, the circulation pump remains in operation according to the time schedule. The pumps is switched off when this function is deactivated.

The **Mixing valve always active** function allows the heat exchanger to maintain the charging temperature using the mixing valve. The heat exchanger charging pump remains switched on and the return flow temperature is not limited outside the times-of-use.

Stop storage tank charging

The controller stops charging the storage tank when the water temperature in the storage tank measured at sensor SF1 exceeds the temperature $T = \text{Charging temperature} + \text{Hysteresis}$ by 0.1 °C . When there is no heating operation or when the flow temperature demand in the system is lower, the corresponding valve is closed.

The storage tank charging pump is switched off when the charging temperature at sensor VFS has fallen below the *Storage tank charging pump deactivation limit*; however, at the latest, after $t = 2 \times \text{Transit time of the primary valve}$.

In the default setting, the storage tank is charged by 5 °C to at least 50 °C when the storage tank temperature falls below 40 °C . The charging temperature is 55 °C . On completing the storage tank charging, the heating valve is closed and the charging pump continues to run until the charging temperature falls below 50 °C .

Functions	WE	Configuration
Storage sensor SF1	ON	Co4 -> Fb00 = ON
Storage tank system	OFF	Co4 -> Fb10 = ON
Circulation pump	OFF	Co4 -> Fb04
Mixing valve always active	OFF	Co4 -> Fb11

Parameters	WE	Parameter level / Range of values
DHW demand ON	40 °C	PA4 / 20 to 90 °C
Hysteresis	5 °C	PA4 / 0 to 30 °C
Charging temperature	55 °C	PA4 / 20 to 90 °C
Storage tank charging pump deactivation limit	50 °C	PA4 / 20 to 90 °C

6.3 Priority operation

In many district heating systems with primary DHW heating, the allotted amount of water is only intended to supply the heating system. As a result, the capacity required for DHW heating needs to be taken from the heating system when great heating loads occur; and this, until DHW heating has been concluded.

Nevertheless, heating operation is not to be simply interrupted. Only the amount of energy required for DHW heating is to be deducted. This can be achieved by using the priority functions **Reverse control** and **Set-back operation**.

6.3.1 Reverse control

In all systems with DHW heating and at least one heating circuit with a control valve, the DHW heating can be given priority by applying a reverse control. With the setting Co4 -> Fb06 = ON, the charging temperature can be monitored. If the temperature also falls below the charging temperature after the time period set in function block Fb07 has elapsed, the heating circuit is closed and the set point remains the same.

Which circuit is closed depends on how the system (An1) is configured:

- ▶ An1 2: Heating circuit with the highest flow set point
- ▶ An1 4: Heating circuit
- ▶ An1 5: Heating circuit 1;
Switching off the pump heating circuit with Co4 -> Fb05 possible.
- ▶ An1 7: Pre-control circuit of heating
- ▶ An1 8: Pre-control circuit of heating
- ▶ An1 9: Heating circuit 1
- ▶ An1 10: Both heating circuits

Functions	WE	Configuration
Reverse control	ON	Co4 -> Fb06 = ON
Time until reverse control	ON	Co4 -> Fb07*
		* Co4 -> Fb07 = ON: 2 minutes Co4 -> Fb07 = OFF: 10 minutes

6.3.2 Set-back operation

In all systems with DHW heating and at least one heating circuit with control valve, DHW heating can be given priority by applying set-back operation. The charging temperature can be monitored with the setting Co4 -> Fb06 = OFF and *Activate priority in case of deviation* > 0.

Function	WE	Configuration
Reverse control	ON	Co4 -> Fb06 = OFF
	0 °C	Activate priority in case of deviation / 0 to 30 °C

Note!

The priority operation is deactivated with the setting Co4 -> Fb06 = OFF and *Activate priority in case of deviation* = 0!

6.4 Forced charging of the DHW storage tank

To provide the full room heating performance when the time-of-use of the heating circuits begins, existing storage tanks are charged one hour before the time-of-use of the heating circuits starts. For the individual controller, this means that storage tank charging is activated when the water temperature in the storage tank falls below the adjusted deactivation value of $T = \text{DHW demand ON} + \text{Hysteresis}$. The forced charging of the storage tank does not take place when the DHW circuit is not activated at the beginning of the time-of-use set for the heating circuit(s).

Note!

This function is not available when a storage tank thermostat is used.

6.5 Thermal disinfection of the DHW storage tank

In all systems with DHW heating, the DHW storage tank is thermally disinfected on a selected *Day of the week* (1 to 7) or every day (0). The storage tank is heated up to the adjusted *Disinfection temperature*. The charging set point is always higher than the *Disinfection temperature* by the value in *Charging boost*. Disinfection begins at the adjusted *Start time* and, at the latest, ends at the specified *Stop time*.

When the *Disinfection temperature* has not been reached at the end of the thermal disinfection cycle, an ERR-2 alarm is generated and  blinks on the display. This alarm can be confirmed by opening up Co4 -> Fb08.

The alarm is automatically reset when the *Disinfection temperature* is properly reached during the following thermal disinfection cycle.

Thermal disinfection for preventing legionella infection causes

- ▶ high return flow temperatures during the disinfection cycle (return flow temperature limitation suspended),
- ▶ high storage temperatures after thermal disinfection has been concluded,
- ▶ lime scale (possibly), which can have a negative effect on heat exchanger performance.

Note!

This function is not available when a storage tank thermostat is used.

Functions	WE	Configuration
Storage sensor SF1	ON	Co4 -> Fb00 = ON
Thermal disinfection	OFF	Co4 -> Fb08 = ON
	3	Day of the week / 1-7, 1, 2, ..., 7 with 1-7 = every day, 1 = Monday, ..., 7 = Sunday
	70 °C	Disinfection temperature / 60 to 90 °C
	5 °C	Charging boost / 0 to 30 °C
	00:00	Start time / 00:00h to 23:30h (in steps of 30 minutes)
	04:00	Stop time / 00:00h to 23:30h (in steps of 30 minutes)

7 System-wide functions

7.1 Automatic summer time/winter time changeover

The clock is automatically adjusted on the last Sunday in March at 2.00h and on the last Sunday in October at 3.00h.

Function	WE	Configuration
Summer time/winter time changeover	ON	Co5 -> Fb05 = ON

7.2 Frost protection

The **Frost protection** function does not work in manual mode.

The heating system is automatically monitored for frost protection. The operation of a pump, a heating circuit or DHW circuit as a frost protection measure is indicated by ❄ on the display. If the outdoor temperature drops below 0 °C, the heating and circulation pumps are activated. The DHW storage tank is charged to 10 °C.

7.3 Forced operation of the pumps

When the heating circuit pumps have not been activated for 24 hours, forced operation of the pumps is started between 12.00h and 12.01h. This is done to avoid that the pumps get stuck when they are not operated for a longer period of time. The forced operation of the storage tank or heat exchanger charging pump is operated between 12.01h and 12.02h.

7.4 Return flow temperature limitation

The temperature difference between the flow and return flow indicates how well the energy is used: the greater the difference, the higher the efficiency. A return flow sensor is sufficient to evaluate the temperature difference when the flow temperatures are preset. The return flow temperature can be limited either to a value depending on the outdoor temperature (variable) or to a fixed set point.

When the temperature measured at return flow sensor RfF exceeds the *Limitation factor*, the set point of the flow temperature (flow temperature of the heating system, charging temperature) is reduced. As a result, the primary flow rate is reduced and the return flow temperature falls. The set point reading (flow temperature of the heating system, charging temperature) blinks to indicate that a return flow limitation is active.

System-wide functions

Function	WE	Configuration
Return flow sensor RüF1, 2, 3	OFF 1.0	Co1, 2, 3 -> Fb01 = ON Limitation factor / 0 to 25.5
Parameters	WE	Parameter level / Range of values
Max. return flow temperature	65 °C	PA1, 2, 3 / 20 to 90 °C
Min. return flow temperature	20 °C	PA1, 2, 3 / 20 to 90 °C

In systems with a DHW in a secondary circuit, the control during DHW heating uses the *Return flow limitation temperature for DHW* parameter (systems Anl 2, 4, 5 and 10). In the transition time or in summer mode, the heating circuit can be operated with a lower return flow temperature while at the same time performing proper storage tank charging.

The *Return flow limitation temperature for DHW* parameter can also be active in systems Anl 4, 5, 7, 8, 9 and 10 at a separate return flow sensor. The separate sensor RüFTW (return flow sensor for DHW) must in this case be installed in the return flow of the DHW circuit.

Note!

*In system Anl 2, the sensor RüFprim is installed in the return flow of the primary circuit. In this case, the **Return flow sensor, primary** function must be activated (Co5 -> Fb01 = ON).*

Function	WE	Configuration
Return flow sensor in DHW circuit	OFF 1.0	Co4 -> Fb02 = ON Limitation factor / 0 to 25.5
Parameter	WE	Parameter level / Range of values
Return flow limitation temperature for DHW	45 °C	PA4 / 20 to 90 °C

Note!

To ensure that the preset return flow temperature limit can be met, make sure that

- the heating characteristic is not adjusted to ascend too steeply,*
- the speed of the circulation pumps is not set too high,*
- the heating systems have been calibrated.*

7.5 Condensate accumulation control

Activate the **Condensate accumulation control** function to start up condensate accumulation plants, in particular to avoid problematic excess temperatures. The controller response to set point deviations which cause the primary valve to open is attenuated. The controller response to set point deviations which cause the control valve to close remains unaffected.

In systems Anl 6 and 9, the limitation applies to all control valves; in all other systems, it applies to the control valve with the highest flow temperature set point.

In systems with DHW heating on the primary side (Anl 7 and 8), the **Condensate accumulation control** function must be configured separately under Co4.

Functions	WE	Configuration
Condensate accumulation control	OFF	Co5 -> Fb07 = ON
	2 °C	Maximum system deviation / 2 to 10 °C
Condensate accumulation control (Anl 7 and 8)		Co4 -> Fb13 = ON
	2 °C	Maximum system deviation / 2 to 10 °C

Note!

The condensate accumulation control function can only be activated when no on/off control has been configured, i.e. Co5 -> Fb14 = ON.

7.6 Compensating for time delays

The controller regulates the control circuit with the highest flow set point with the secondary flow sensor. If the sensor is placed on the secondary side directly downstream of the heat exchanger and the setting Co5 -> Fb06 = ON configured, any time delays due to changes in temperature at a distant flow sensor do not occur anymore. This measure used with a condensate accumulation control means that the control can intervene before the control valve releases unproportionally too much heat exchanger area.

Functions	WE	Configuration
Flow sensor, secondary VFsek	ON	Co5 -> Fb00 = ON
Compensation of time delays	OFF	Co5 -> Fb06 = ON

7.7 Three-step control

The flow temperature can be controlled using a PI algorithm. The valve reacts to pulses that the controller emits when a system deviation occurs. The length of the first pulse, in particular, depends on the extent of the system deviation and the selected *Proportional gain* K_P (the pulse length increases as K_P increases). The pulse and pause lengths change continuously until the system deviation has been eliminated. The pause length between the single pulses is greatly influenced by the *Reset time* T_N (the pause length increases as T_N increases).

The *Transit time* T_Y specifies the time required by the valve to travel through the range of 0 to 100 %.

The three-step control can be configured separately for individual heating circuits, for the DHW heating and for the pre-control circuit.

Functions	WE	Configuration
Three-step control for heating circuit	ON	Co1, 2, 3 -> Fb15 = ON
	0.5	K_P (proportional gain) / 0.1 to 50.0
	200 s	T_N (reset time) / 1 to 999 s
	120 s	T_Y (transit time) / 15, 30, ..., 240 s
Three-step control for DHW heating	ON	Co4 -> Fb09 = ON
	0.5	K_P (proportional gain) / 0.1 to 50.0
	200 s	T_N (reset time) / 1 to 999 s
	120 s	T_Y (transit time) / 15, 30, ..., 120 s
Three-step control for pre-control circuit	ON	Co5 -> Fb14 = ON
	0.5	K_P (proportional gain) / 0.1 to 50.0
	200 s	T_N (reset time) / 1 to 999 s
	120 s	T_Y (transit time) / 15, 30, ..., 240 s

No further pulses are issued at the three-step outputs when the control signal deactivation function is activated when the total of the timing pulses (uninterrupted in one direction) is larger than three times the control valve transit time T_Y . In this case, it can be assumed that the control valve is either completely open or completely closed; other signals do not cause any changes in the control valve.

Function	WE	Configuration
Control signal deactivation	OFF	Co5 -> Fb18 = ON

7.8 On/off control

The flow temperature can be controlled by an on/off signal. The controlled valve is opened when the flow temperature falls below the set point by $T = 0.5 \times \text{Hysteresis}$. When the flow temperature exceeds the set point by $T = 0.5 \times \text{Hysteresis}$, the control valve is closed. The greater the *Hysteresis* selected, the lower the switching frequency. The *UP lag time* parameter indicates the time span which the circulation pump continues to run after the control valve is closed (the parameter only needs to be set for the heating circuits HK1, HK2 and HK3).

By entering *Minimum activation time*, a burner once switched on remains switched on for the time entered, regardless of how the temperature develops. Likewise, a burner that has been switched off due to the temperatures remains switched off for the time entered in *Minimum deactivation time*.

The on/off control can be configured separately for the individual heating circuits and for the pre-control circuit.

Functions	WE	Configuration
Three-step control for heating circuit	ON	Co1, 2, 3 -> Fb15 = OFF
	5 °C	Hysteresis / 1 to 30 °C
	120 s	Minimum activation time / 0 to 600 s
	120 s	Minimum deactivation time / 0 to 600 s
	240 s	UP lag time / 120 to 1200 s
Three-step control for pre-control circuit	ON	Co5 -> Fb14 = OFF
	5 °C	Hysteresis / 1 to 30 °C
	120 s	Minimum activation time / 0 to 600 s
	120 s	Minimum deactivation time / 0 to 600 s

7.9 Continuous-action control

The flow temperature can be controlled using a PID algorithm. The valve receives an analog 0 to 10 V signal issued by the controller. The proportional-action component causes an immediate change in the 0 to 10 V signal when a system deviation arises (the larger the K_P , the greater the change). The integral-action component first affects the control after a certain time: T_N stands for the time that passes until the I-action component has changed the output signal so far as the P-action component just did (the larger the T_N , the slower the rate in change). The D-action component causes every change in system deviation to have any increased effect on the output signal (the larger the T_V , the more intensified the change).

The continuous-action control can be configured separately for individual heating circuits, for the DHW heating and for the pre-control circuit.

Functions	WE	Configuration
Continuous-action control for heating circuit	OFF	Co1, 2, 3 -> Fb14 = ON
	0.5	K _P (gain) / 0.1 to 50.0
	200 s	T _N (reset time) / 1 to 999 s
	0 s	T _V (derivative-action time) / 0 to 999 s
Continuous-action control for DHW heating	OFF	Co4 -> Fb14 = ON
	0.5	K _P (gain) / 0.1 to 50.0
	200 s	T _N (reset time) / 1 to 999 s
	0 s	T _V (derivative-action time) / 0 to 999 s
Continuous-action control for pre-control circuit	OFF	Co5 -> Fb19 = ON
	0.5	K _P (gain) / 0.1 to 50.0
	200 s	T _N (reset time) / 1 to 999 s
	0 s	T _V (derivative-action time) / 0 to 999 s

7.10 Forwarding the outdoor temperature

The outdoor temperature can be passed on over the analog output AA (0 to 10 V, terminal 11) (0 to 10 V corresponding with -40 to 50 °C outdoor temperature).

Function	WE	Configuration
Outdoor temperature passed on over AA	OFF	Co5 -> Fb15 = ON

7.11 Flow rate/capacity limitation over a pulse input

Flow rate/capacity limitation can be implemented based on a pulse signal.

There are three different operating situations:

- ▶ A system with simultaneous room heating and DHW heating requires maximum energy.
- ▶ A system with a fully charged storage tank which performs only room heating requires less energy.
- ▶ A system which suspends room heating during DHW heating requires less energy.

As a result, three different maximum limit values can be specified:

- ▶ *Max. limit value* to determine the absolute upper limit
- ▶ *Max. limit value for heating* for exclusive operation of the room heating
- ▶ *Max. limit value for DHW* for exclusive operation of the DHW heating

In all systems without DHW heating, only the *Max. limit value* for the flow rate or capacity can be set.

A heat meter with pulse output connected at input V_{\max} (terminal 30) can be used either to limit the system flow rate (parameter code: U) or the system capacity (parameter code: P). The pulse weighting of the heat meter (WMZ) and the type of limitation selected must be entered. The displayed value corresponds to the unit l/pulse or kWh/pulse.

When the pulse rate reaches the current maximum limit, the flow set point of the control circuit RK1 is reduced. How strongly the controller responds is determined by the *Proportional-action coefficient for limitation*.

Example to determine the limit value:

If a capacity of 30 kW is to be limited, the following limit value must be set for a heat meter with an output of one pulse per kilowatt-hour:

$$P = \frac{30 \text{ kW}}{1 \text{ kWh / pulse}} = 30 \text{ pulse / h}$$

Settings for capacity limitation

Functions	WE	Configuration
Limitation of heat meter (WMZ)	OFF	Co5 -> Fb08 = OFF
Pulse input for flow rate or capacity limitation	OFF	Co5 -> Fb09 = ON, select: P CONST: Limitation constant 4-Pt: Limitation acc. to 4-point characteristic
	10	Pulse weighting / 0.1 to 10
Parameters	WE	Parameter level / Range of values
Maximum capacity of the entire system	50 kW	PA5 / 0.1 to 5999 kW
Maximum capacity of the DHW heating	50 kW	PA5 / 0.1 to 5999 kW
Proportional-action coefficient for the limitation	1.0	PA5 / 0.1 to 10
Select <i>CONST</i> additionally for:		
Maximum capacity of the heating	50 kW	PA5 / 0.1 to 5999 kW
Select <i>4-Pt</i> additionally for:		
Outdoor temperature Point 1	-15 °C	PA5 / -30 to 90 °C
Point 2	- 5 °C	
Point 3	5 °C	
Point 4	15 °C	
Maximum capacity limitation, points 1 to 4	50 kW	PA5 / 0.1 to 5999 kW

Settings for flow rate limitation

Functions	WE	Configuration
Limitation of heat meter (WMZ)	OFF	Co5 -> Fb08 = OFF
Pulse input for flow rate or capacity limitation	OFF	Co5 -> Fb09 = ON, select: U CONST: Limitation constant 4-Pt: Limitation acc. to 4-point characteristic
	10	Pulse weighting / 0.1 to 10
Parameters	WE	Parameter level / Range of values
Maximum flow rate of the entire system	9 m ³ /h	PA5 / 0.01 to 99.9 m ³ /h
Maximum flow rate of the DHW heating	9 m ³ /h	PA5 / 0.01 to 99.9 m ³ /h
Proportional-action coefficient for the limitation	1.0	PA5 / 0.1 to 10
Select <i>CONST</i> additionally for:		
Maximum flow rate of the heating	9 m ³ /h	PA5 / 0.01 to 99.9 m ³ /h
Select <i>4-Pt</i> additionally for:		
Outdoor temperature Point 1	-15 °C	PA5 / -30 to 90 °C
Point 2	- 5 °C	
Point 3	5 °C	
Point 4	15 °C	
Maximum flow rate limitation, points 1 to 4	9 m ³ /h	PA5 / 0.01 to 99.9 m ³ /h

A second pulse counter can be connected at terminal 29. The pulses entered are stored in the holding registers 40031 (low byte) and 40032 (high byte). The associated duration on the holding registers 40035 (low byte) and 40036 (high byte). First, the low byte counts upwards (0 to 65535). If several pulses arrive, the counting value is formed by multiplying the low byte with the high byte (32-bit value).

7.12 Locking manual level

To protect the heating system, this function can be used to lock manual level. When this function has been activated, automatic mode is started when the rotary switch is set to +, - or 0.

Function	WE	Configuration
Locking manual levels	OFF	Co5 -> Fb10 = ON

8 Operational faults

Malfunctions or faults are indicated by the ! icon blinking on the display. *Error* immediately appears on the display. Press the enter key to open the error level. It may be possible to view several error alarms by pressing the enter key. As long as an error alarm is present, the error level appears in the display loop, even though it has not been opened by pressing the enter key.

In the error level, the controller indicates a defective sensor by displaying the corresponding sensor combination. A fault is displayed as specified in the list below.

8.1 Error list/sensor failure

- ▶ ERR 1 Sensor broken in RK1 (in connection with the corresponding sensor icon)
- ▶ ERR 2 Sensor broken in RK2 (in connection with the corresponding sensor icon)
- ▶ ERR 3 Sensor broken in RK3 (in connection with the corresponding sensor icon)
- ▶ ERR 4 Sensor broken in DHW circuit (in connection with the sensor icon)
- ▶ ERR 5 Sensor broken in primary circuit (in connection with the sensor icon)
- ▶ ERR -1 Standard data entered again (default settings)
- ▶ ERR -2 Final temperature of the thermal disinfection not reached
- ▶ ERR -3 Mode selector switch 1 defective
- ▶ ERR -4 Mode selector switch 2 defective
- ▶ ERR -5 Mode selector switch 3 defective
- ▶ ERR 10 Temperature limitation of DHW heat exchanger active

In the error level, *ERR1* to *ERR5* on the display indicates the sensor failures as per the error list. Detailed information over a sensor failure can be retrieved within the information level by polling individual temperatures: each sensor icon displayed together with ---- indicates a defective sensor. The following list explains how the controller responds to the failure of the different sensors.

- ▶ **Outdoor sensors AF:** When the outdoor sensor fails, the controller uses a flow temperature set point of 50 °C or the *Max. flow temperature* (when the *Max. flow temperature* is smaller than 50 °C).
- ▶ **Flow sensor VF:** When the flow sensor is defective, the controller continues to work with the valve in the last position.
- ▶ **Flow sensor in the DHW heat exchanger VFT:** The DHW control valve is closed when the sensor fails.
- ▶ **Flow sensor in the DHW storage tank VFS:** The flow set point for the DHW heat exchanger is only controlled with VFT. The display blinks.
- ▶ **Return sensor RÜF:** When the return flow sensor is defective, the controller continues to work without the return flow temperature limitation function.

- ▶ **Room sensor RF:** Upon failure of the room sensor, the controller functions according to the settings for operation without a room sensor. For example, optimized operation is switched over to reduced operation. Adaptation operation is interrupted. The last determined heating characteristic is not changed anymore.
- ▶ **Storage tank sensors SF1 and SF2:** Upon failure of one of these sensors, the storage tank is not charged anymore.

Sensor breakage status

In InF7 and InF8 levels, it is possible to see which sensor does not function properly. The status of the sensors is shown over function blocks together with the string *bruch*. A function block is assigned to each sensor and is set when the sensor data input is incorrect after one minute.

- ▶ **InF7** (only with Co7 -> Fb05 = ON): Error status display of the recognized LON controller and its sensor breakage status, for example
7403b = TROVIS 5174 Controller, sensor breakage bit 03
7919b = TROVIS 5179 Controller, sensor breakage bit 19
The relationship between the set bit and the associated sensor can be found in the Mounting and Operating Instructions (EB) of the recognized LON controller.
- ▶ **InF8:** Sensor breakage status display of the sensor belonging to the controller. The set bits remain visible in the case of failure for at least one minute (■ appears on the right-hand side of the set bit number, see page 69).

When an SMS text message alarm or fax alarm is issued (see sections 8.6 and 8.7) *Fuehl* appears on the display next to the status of the connected sensors. One “o” appears for every working sensor and one “F” for every defective sensor. The sequence is the same as the set bits on page 69.

- ▶ **Example:** “Fuehl:oFoFFooooooooooooooooo” = Defective resistor inputs 1, 3 and 4 (return flow sensor RüF1, room sensor RF1 and flow sensor VF1)

8.2 Collective error alarm

Should an error occur in the controller, it can be indicated over binary output BA4. BA4 is activated when the error status register does not equal 0. BA4 is a DC voltage output in an open collector circuit and may only be loaded with 24 V/10 mA at the maximum. If the **Collective error alarm** function is active, BA4 is no longer available for pump management.

Function	WE	Configuration
Potentiometer in pre-control circuit	OFF	Co5 -> Fb16 = ON

Sensor breakage status:

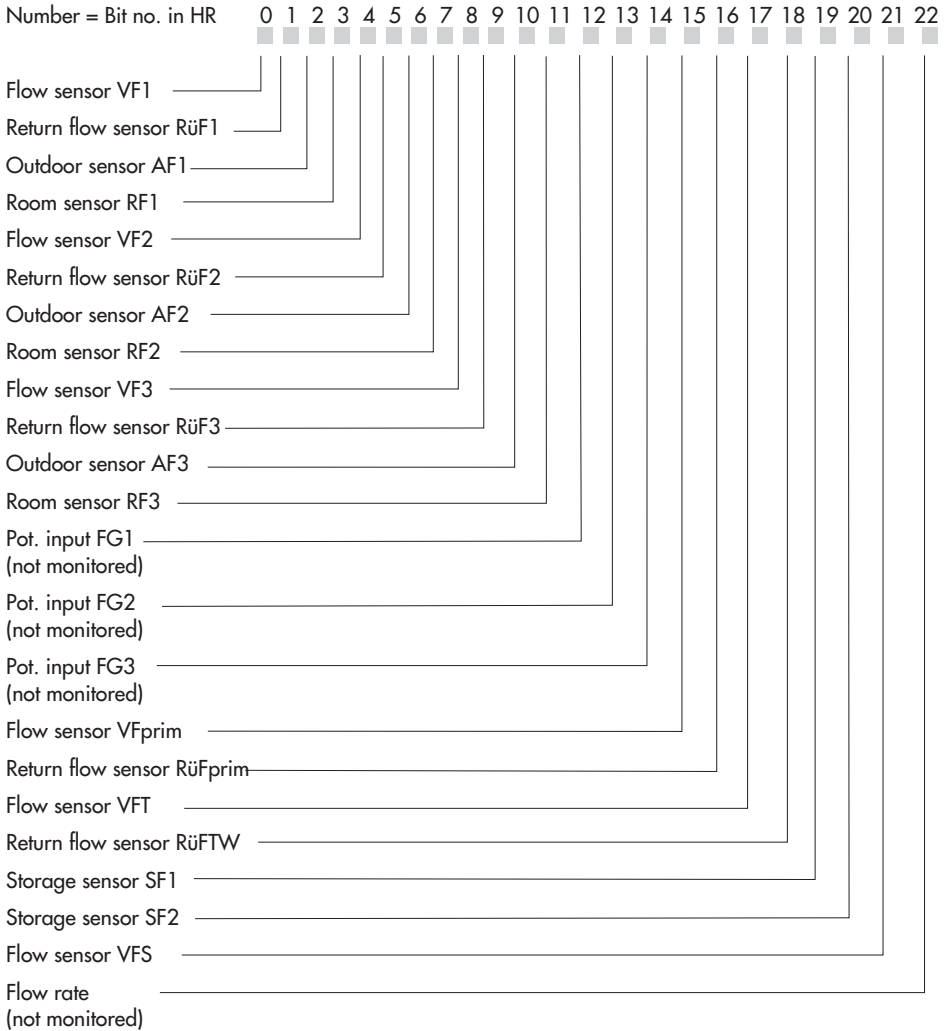

8.3 Temperature monitoring

The flow temperature and the room temperature can be monitored for any deviations. This function is activated in Co5 -> Fb20. The controller issues an alarm when:

- ▶ the flow temperature deviates from its set point by more than 10 °C for more than 30 minutes
- ▶ the room temperature falls below its set point by 2 °C for more than 30 minutes
- ▶ the return flow temperature limitation is active for more than 30 minutes.

When one of these conditions occurs, the bit for the associated sensor is set in holding register 857. A set bit in holding register HR 857 causes the bit 4 to be set in the error status register FSR2 (HR 61) and in the error archive register 2 (HR 63) and the error counter (HR 64) is incremented.

Function	WE	Configuration
Temperature monitoring	OFF	Co5 -> Fb20 = ON

Holding register 857 (■ appears on the right-hand side of the set bit number)

Number = Bit number in HR

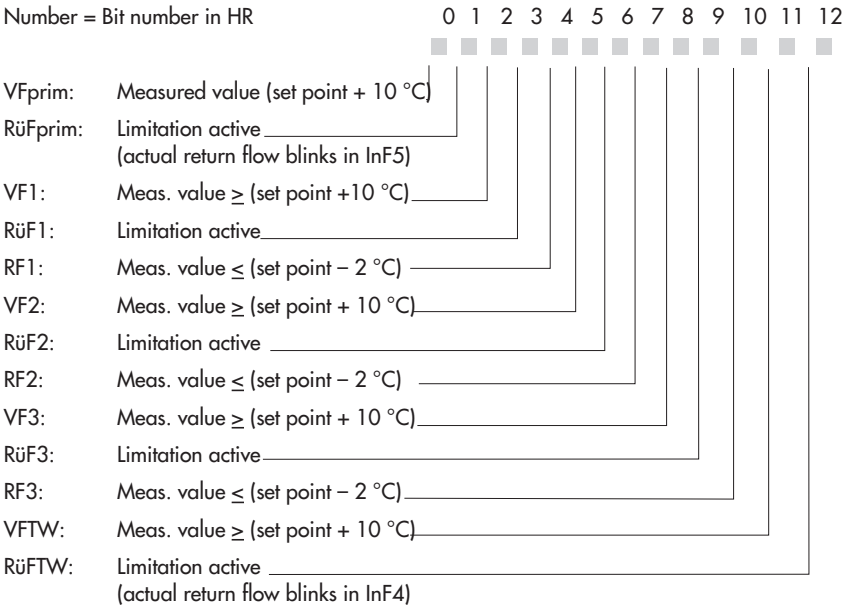

8.4 Monitoring the input terminals for limit violations

The controller provides the option to apply limits (in % of measuring range) to two selected inputs (temperature sensor or analog inputs) and to issue an alert to a higher-level control system by writing in the error status register. Directly after setting the function block, select the terminal that is to be monitored and the condition that triggers the alarm according to the following codes:

- ▶ **Alarm when upper limit is exceeded (OGW)**
Lower limit: 0 %
Upper limit: Any
- ▶ **Alarm when bottom limit is not reached (UGW)**
Lower limit: Any
Upper limit: 100 %
- ▶ **Alarm when the limits is exceeded or not reached**
Lower limit: $> 0 \% < \text{OGW}$
Upper limit: $> \text{UGW} < 100 \%$
- ▶ **Alarm ON, when UGW is exceeded and alarm OFF when OGW is not reached**
Lower limit: $> \text{OGW} < 100 \%$
Upper limit: $> 0 \% < \text{UGW}$

Input to which temperature sensors are connected have readings in °C (measuring range from -30 to 160 °C); analog input readings are shown in % of the measuring range.

In systems An1, 3, 4, 6, 7 and 10, the limit alarm is made with "BA EIN" over an analog relay. A make contact or break contact function can be assigned to the relay by selecting "STEIG" (= rising signal edge) and "FALL" (= negative signal edge) respectively. The limit alarm also appears in the error status register by selecting "Fsr-E".

Note!

The associated binary output is marked in the wiring plan with GWx and GWy and depends on the system code number (An1).

Function	WE	Configuration
Limit monitoring at terminal x, y		Co5 -> Fb11, 12 = ON Terminal number Upper/lower limit Signal edge, binary output Fsr-A/Fsr-E: Status alarm to error status register ON/OFF BA EIN/BA AUS: Setting/not setting the binary input FALL/steig: Negative signal edge/increasing signal edge

8.5 Error status register

The HR 60 and HR 61 error status registers (holding register - 16-bit) are used to indicate controller or system errors. HR 60 contains general alarms, whereas special faults are entered in HR 61. In modem mode (Co9 -> Fb01 = ON), the change in state of HR 60 or HR 61 causes the controller to dial the control system.

In InF8 level the bits of the error status register are displayed:

- ▶ FSR1 (general error):
The corresponding block at the top is set for every bit set
- ▶ FSR2 (special error):
by pressing  key, the set bits are displayed similar to FSR1

In both cases, the blocks 20 to 23 are visible when a bit is set in another error status register (which is currently not visible) to make it immediately recognizable whether one of the maximum 32 error flags has been set.

Holding register 60 (A set bit is indicated by ■ on the right of number):

Number = Bit no. in HR	0	1	2	3	4	5	6	7	8	9	10	11
Bit value	2 ⁰	2 ¹	2 ²	2 ³	2 ⁴	2 ⁵	2 ⁶	2 ⁷	2 ⁸	2 ⁹	2 ¹⁰	2 ¹¹
Sensor breakage	D0											
Default values read	D1											
-	D2											
Mode switch RK1 faulty	D3											
Mode switch RK2 faulty	D4											
Mode switch RK3 faulty	D5											
Unauthorized access	D6											
Error alarm of a BE	D7											
WMZ error alarm issued to meter bus	D8											
WMZ error alarm issued	D9											
-	D10											
Fault alarm binary output changed	D11											

Example of a transfer to the control system:

The error status register is transferred as a word <w> in a holding register (HR) whose value is calculated as follows:

$$\langle w \rangle = ([D0] \times \langle 1 \rangle + [D1] \times \langle 2 \rangle) + \dots + ([D11] \times \langle 2048 \rangle)$$

Holding register 61 (A set bit is indicated by ■ on the right of number):

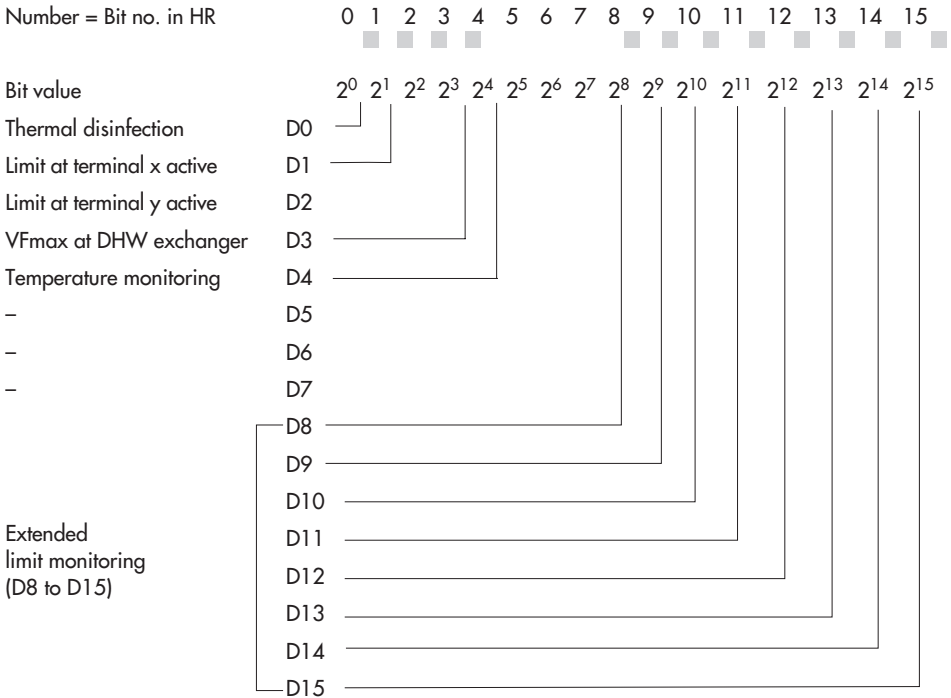

8.6 Error alarms

Error alarms can be sent over a modem either directly to the control station or over the SMS text message function to a mobile phone or to a fax. Just one function (Modbus, SMS function or fax function) can be selected at one time since the functions use the same interface. The error alarms to a mobile phone and to a fax contain the number of the affected error status register (FSR1), the fault as per error status register (BitNo), the controller ID and the bit number (Bit xx).

8.6.1 Sending text message in case of a fault alarm

Currently, text messages can only be sent to the German D1 network. The corresponding access numbers into the D1 network as well as the mobile phone number of the recipient must be set in the PA9 level:

- ▶ **D1 access number:** 0171 252 10 02
(add 0 in front when dialing from a private branch exchange)
Digits 0 to 9, P = pause, - = end, max. 22 characters
The access number is assigned by Deutsche Telekom and may alter.
- ▶ **Mobile phone number:** 49 xxx yyyyyyy , where xxx stands for 160, 171 or any other valid D1 dialing code and yyyyyyy represents the specific phone number of the mobile phone you wish the alarm to be sent to.
Digits 0 to 9, P = pause, - = end, max. 14 characters

Note! Currently, text messages can only be sent to the German D1 network.

Functions	WE	Configuration
Modbus	ON	Co9 -> Fb00 = OFF
Modem	OFF	Co9 -> Fb01 = OFF
Text message via SMS	OFF	Co9 -> Fb06 = ON
SMS dialing procedure	OFF	Co9 -> Fb07
Alarm sent per fax	OFF	Co9 -> Fb10 = OFF
Parameters	WE	Parameter level / Range of values
Access number (UGno)	-	PA9 / configurable as required*
Mobile phone number (HAndY)	-	PA9 / configurable as required**
* Digits 0 to 9, P = pause, - = end, max. 14 characters		
** Digits 0 to 9, P = pause, - = end, max. 22 characters		

8.6.2 Sending fax in case of a fault alarm

The device type is forwarded in addition to a detailed error description. The recipient's fax number must be programmed in the PA9 level. Optionally, also the sender's station ID can be programmed; this number will then be forwarded as well. If no station ID is specified, the string "nicht verfügbar" (not available) is inserted.

- ▶ **Fax number:** Digits 0 to 9, o = Pause, - = end, max. 14 characters
(place an additional 0 in front when dialing from a private branch exchange)

► **Station ID:** Digits 0 to 9, P = pause, - = end, max. 14 characters

Functions	WE	Configuration
Modbus	ON	Co9 -> Fb00 = OFF
Modem	OFF	Co9 -> Fb01 = OFF
Alarm sent as text message	OFF	Co9 -> Fb06 = OFF
Alarm sent per fax	OFF	Co9 -> Fb10 = ON
Fax dialing procedure	OFF	Co9 -> Fb11
Parameters	WE	Parameter level / Range of values
Fax number (tELno)	-	PA9 / configurable as required*
Station ID (St Id)	-	PA9 / configurable as required*
* Digits 0 to 9, P = pause, - = end, max. 14 characters		

9 Communication

Using the serial system bus interface, the TROVIS 5179 District Heating Controller can communicate with a building control system. In combination with a suitable software for process visualization and communication, a complete control system can be implemented.

The following communication settings are possible:

– Operation with a dial-up modem at the RS-232-C system bus interface

Basically, communication is only established automatically when errors occur. The controller works autonomously. Nevertheless, the modem can dial up to the controller at any time to read data from it or otherwise influence it, if necessary. We recommend to use the modem connecting cable (1400-7139).

– Operation with a leased line modem at the RS-232-C system bus interface

Communication is established via a permanent connection between two leased line modems. This setup is applied for long-distance transmissions or when different signal level converters are used. The connection between controller and modem can also be established via the modem connecting cable (1400-7139).

– Operation at a four-wire bus

To establish the link between controller and bus line, the signal level needs to be converted by a converter (SAMSON's cable converter 1400-7308).

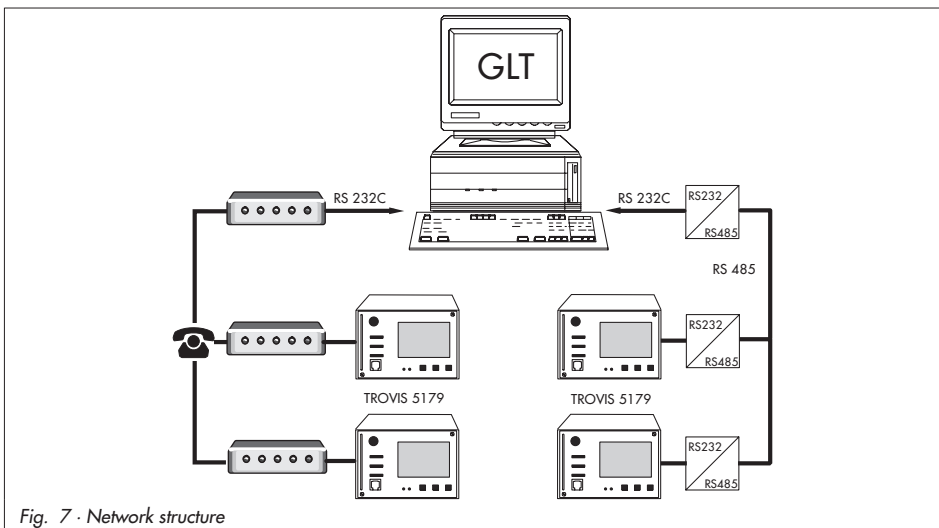

Fig. 7 · Network structure

The TROVIS 5179 District Heating Controller is fitted with a Modbus interface RS-232. Optionally, a cable converter for four-wire bus (1400-7308) is available.

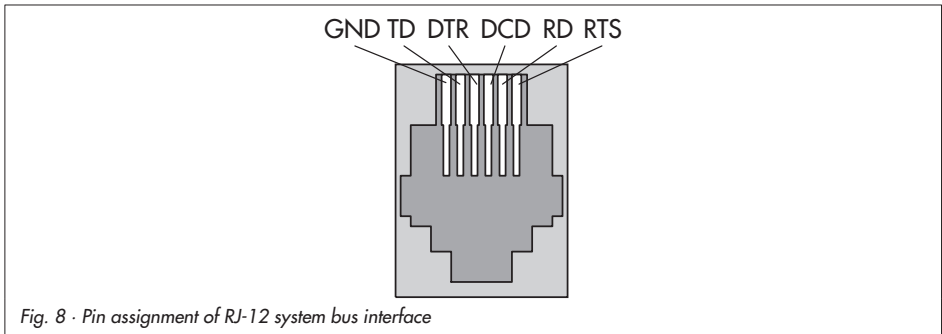

Fig. 8 - Pin assignment of RJ-12 system bus interface

9.1 RS-232-C system bus interface

The system bus connection is located at the back of the controller housing (RJ-12 jack). In this case, the controller can be connected either directly to the serial interface of a PC (point-to-point connection) or to a (dial-up) modem. A dial-up modem is required if the controller is to be connected to the telecommunications network. In this case, the controller works autonomously and can issue an alarm call to the building control station when errors occur. Additionally, the building control station can dial up the controller, read data from it, and send new data once the valid key number has been written to the holding register no. 40070. On recognizing the key code from the controller as valid, the register value "1" confirms writing permission. In any other case, the register value remains at "0". Any further establishment of communications requires the writing permission to be acquired by resending the key number.

Note!

If a wrong key number has been written to holding register no. 40070 for the third consecutive time, the controller immediately interrupts the modem connection and sets the D6 bit of the error status register (Unauthorized access). As a result, the call to the configured control system is triggered or a text message/fax is sent. Bit D6 is deleted as soon as the error status register has been read by the control system and the connection has been terminated.

In special cases, the **Lock dial-up** function can be selected to stop dial-up in case of faults. Using the **Dial-up also upon corrected fault** function, the controller additionally informs the building control station when a previously registered fault no longer persists.

Functions	WE	Configuration
Modem	OFF	Co9 -> Fb01 = ON
Modem dialing procedure	OFF	Co9 -> Fb02
Lock dial-up	OFF	Co9 -> Fb03
Dial-up also upon corrected fault	OFF	Co8 -> Fb00
Parameters*	WE	Parameter level / Range of values
Station address (ST.-NR)	255	PA9 / 1 to 247 (1 to 999 with Co9 -> Fb04 = ON)
Baud rate (BAUD)	9600	PA9 / 300 to 19200
Cyclic initialization (I)	30 min	PA9 / 0 to 255 min
Modem dial interval between calls (P)	5 min	PA9 / 1 to 255 min
Modem timeout (t)	5 min	PA9 / 1 to 255 min
Number of redial attempts (C)	5	PA9 / 0 to 99
Phone number of building control station (tELno)	-	PA9 / Configurable as required**
Phone number of alternative recipient (rESno)	-	PA9 / Configurable as required**

** Digits 0 to 9, P = Pause, - = End, max. 22 characters

* -> Section 9.3 ("Description of communication parameters to be adjusted")

9.2 RS-232/RS-485 system bus interface (for four-wire bus) in combination with cable converters

A constant bus connection is required (data cable) for operation of the district heating controller in conjunction with cable converters. The bus line is routed to the individual control instruments in an open ring. At the end of the bus line, the data cable is connected to the control station using an RS-485/RS-232 converter (e.g. TROVIS 5484). The maximum range of the bus connection (cable length) is 1,200 meters. A maximum of 32 devices can be connected to such a segment. If you wish to use more than 32 devices in line or need to bridge greater distances, make sure repeaters (e.g. TROVIS 5482) are installed to replicate the signal. With 8-bit addressing, a maximum of 246 devices can be addressed and connected to a bus.

Warning!

You are required to follow the relevant standards and regulations concerning lightning and overvoltage protection on installation.

Functions	WE	Configuration
Modbus	ON	Co9 -> Fb00 = ON
Modem	OFF	Co9 -> Fb01 = OFF
Modbus 16-bit addressing	OFF	Co9 -> Fb04
Parameters*	WE	Parameter level / Range of values
Station address (ST.-NR)	255	PA9 / 1 to 247 (1 to 999 with Co9 -> Fb04 = ON)
Baud rate (BAUD)	9600	PA9 / 300 to 19200

* -> Section 9.3 ("Description of communication parameters to be adjusted")

9.3 Description of communication parameters to be adjusted

Station address (ST.-NR)

This address is used to identify the district heating controller in bus or modem mode. In a system, each controller needs to be assigned a unique address.

Baud rate (BAUD)

In a bus system, the baud rate refers to the transfer speed between control system and district heating controller. In modem mode, baud rate refers to the transfer speed between district heating controller and modem.

The baud rate adjusted at the district heating controller must correspond with the baud rate of the control system, otherwise communication cannot be established.

Cyclic initialization (I)

This parameter defines the period of time for a cyclical issue of the initialization command "ATZ". The command is not issued during dial-up or when connected. "ATZ" causes the configuration profile 0 to be copied to the active profile, provided the modem parameters have been set and saved in profile 0 using a suitable terminal program.

Typical initialization of a modem with a terminal program:

AT & F (restores modem to its factory settings)
 OK (response of the modem)
 ATEOSO = 1 (command input, EO: echo off;
 SO = 1: answer on first ring)

Modem dialing pause (P)

It is recommended to observe an interval of approx. 3 to 5 minutes between dialing up to the control system/or sending a text message or fax to avoid a permanent overloading of the (telecommunications) network. The modem dialing pause is the interval between two dialing attempts.

Modem timeout (t)

When the controller connects to the GLT but without addressing a Modbus data point, the connection is closed after the time specified for *Modem time-out* has elapsed. If the error status register has not been read during the GLT connection, the controller dials up to the GLT again after the *Modem dialing pause (P)* has elapsed.

Number of redialing attempts (C)

The controller tries to dial up to the control system again, observing the *Modem dialing pause*, in case the control station/text messaging center/fax is busy or the function that triggered the call has not been reset by the controller. After the specified number of redialing attempts have failed, the district heating controller dials up the alternative recipient.
Resetting of triggered call = Reading the error status register (HR 40060)

Phone number of control station (tELno)

Enter the phone number of the control system modem including the dialing code, if necessary. Short pauses between the numbers can be entered using P (= 1 second); the end of the string is to be marked by "-". The phone number may include a maximum of 22 characters.

Example: "069, 2 sec. pause, 4009, 1 sec. pause, 0":

0 6 9 P P 4 0 0 9 P 0 - (= 11 characters)

Phone number of the alternative recipient (rESno)

Enter the phone number of the alternative recipient including the dialing code, if necessary. Short pauses between the numbers can be entered using P (= 1 second); the end of the string is to be marked by "-". The phone number may include a maximum of 22 characters.

Example: "069, 1 sec. pause, 654321": 0 6 9 P 6 5 4 3 2 1 - (= 10 characters)

Common modem settings are:

- ▶ EO - Echo off
- ▶ QO - Enable result codes
- ▶ X3 - Dial without checking for dial tone
- ▶ % CO - Data compression off
- ▶ \ N1 - Buffer off, fault correction off
- ▶ V1 - Result codes in text format
- ▶ % B 9600 - Baud rate 9600
- ▶ \ VO - Standard connect result codes

Resetting to default settings

A modem can be reset to its default settings directly at the controller using the key number.

Key number	Command
44	AT&F&W <CR> <LF>
45	AT&F&W ATX3 <CR> <LF> (for branch exchange systems)

Note!

The initialization settings described here are indispensable for operation on a dial-up modem. Nevertheless, it cannot be guaranteed that data are transferred after the initialization settings have been adjusted. Due to the broad range of modems available on the market and the different commands, refer to the operating manual of the modem for further details.

9.4 Meter bus interface

The district heating controller can communicate with up to 3 heat and water meters according to EN 1434-3.

Details on the use of the different heat or water meters can be found in the technical documentation TV-SK 6311.

9.4.1 Activating the meter bus

To successfully transfer data from the heat meter (WMZ) to the district heating controller, the heat meter must use a standardized protocol in accordance with EN 1434-3. It is not possible to make a general statement about which specific data can be accessed in each meter. For details on the different meter makes, refer to the technical documentation TV-SK 6311. All necessary function block parameters to set up the communication with heat or water meters are available in Co9 -> Fb21 to Fb23. The meter bus address, model code and reading mode need to be set in sequence. A meter bus address must be unique and correspond with the address preset in the WMZ.

If the preset meter bus address is unknown, a single heat meter connected to the controller can be assigned the meter bus address 254. The address 255 deactivates the communication with the respective WMZ. The model code to be set for the heat meter can be found in TV-SK 6311. In general, the default setting of 1434 can be used for most devices.

The meters can be read either automatically approx. every 24 hours (24h), continuously (con) or when the coils (= Modbus data points) assigned to the heat meters WMZ1 to WMZ3 are overwritten with the value 1 (Coil) via the system bus interface.

In InF9 info level, "1434" is displayed when the meter bus is activated. Press the enter key to get to the display referring to the meter bus. For each of the three heat meters whose address is not 255, "buSi" (with i = 1, 2, 3) is indicated. Press the enter key again to display the following information about the associated meter:

- ▶ Flow rate (d, cm/h)
- ▶ Total capacity (U, cm³)
- ▶ Capacity (P, kW)
- ▶ Energy (A, MWh, GJ)

- ▶ Flow temperature (b, °C)
- ▶ Return flow temperature (b, °C)
- ▶ Meter identification number (L without enter key, H with enter key)
- ▶ Meter bus address (sent by WMZ) (A, -)

Blinking values in combination with black squares in the top row of the display (fault status of the associated meter → TV-SK 6311) indicate different faults.

Note!

With reading mode “24h”, the displayed values are not updated by opening the “buS1” to “buS3” levels again; the values read during the last cycle remain unchanged.

With reading mode “con”, the values in the levels are not continuously updated. Reopen the specific level to get current values.

Functions	WE	Configuration
Meter bus 1, 2, 3	OFF	Co9 → Fb21 = ON, Fb22 = ON, Fb23 = ON
	255	Meter bus address for WMZ 1, 2, 3 / 0 to 255
	1434	Model code WMZ 1, 2, 3 / P15, PS2, 1434, CAL3, APAiO, SLS
	con	Reading mode WMZ 1, 2, 3 / 24h, con, Coil
Limitation of WMZ	OFF	Co5 → Fb08 = ON
		---: No limitation
		U: Flow rate limitation
		P: Capacity limitation
		U-P: Flow rate and capacity limitation
		by selecting “U”, “P” or “U-P” in addition:
		CONST: Limitation parameter constant
		4-Pt: Limitation acc. to 4-point characteristic, outdoor temperature dependent

9.4.2 Flow rate/capacity limitation using meter bus

Flow rate and/or capacity limitation with the aid of the connected meter bus can be implemented by selecting the type of limitation 2, 3 or 4. The update rate of the measured variable, flow rate and/or capacity, must be smaller than 5 seconds in meter bus operation to carry out a proper limitation. Refer to the technical documentation TV-SK 6311 for details on which listed heat meters fulfill this criterion and can be used for limitation purposes. In case of battery-operated heat meters in particular, please note that some makes react with communication intervals if they are polled too frequently. Other makes could use up their batteries too quickly. The technical documentation TV-SK 6311 provides more details on these matters.

- ▶ A system with simultaneous room heating and DHW heating requires maximum energy.
- ▶ A system with a fully charged storage tank which performs only room heating requires less energy.
- ▶ A system which suspends room heating during DHW heating requires less energy.

As a result, three different maximum limit values can be specified:

- ▶ *Max. limit value* to determine the absolute upper limit
- ▶ *Max. limit value for heating* for exclusive operation of the room heating
- ▶ *Max. limit value for DHW* for exclusive operation of the DHW heating

In all systems without DHW heating or without heating circuit, only the *Max. limit value* for the flow rate or capacity can be set.

Capacity limitation

Parameters	WE	Parameter level / Range of values
Maximum capacity of the entire system	50 kW	PA5 / 0.1 to 5999 kW
Maximum capacity of the DHW heating	50 kW	PA5 / 0.1 to 5999 kW
Proportional-action coefficient for limitation	1.0	PA5 / 0.1 to 10
By selecting "CONST" additionally		
Maximum capacity of the heating	50 kW	PA5 / 0.1 to 5999 kW
By selecting "4-Pt" additionally		
Outdoor temperature Point 1	-15 °C	PA5 / -30 to 90 °C
Point 2	- 5 °C	
Point 3	5 °C	
Point 4	15 °C	
Maximum limit of capacity, points 1 to 4	50 kW	PA5 / 0.1 to 5999 kW

Flow rate capacity

Parameters	WE	Parameter level / Range of values
Maximum flow rate of the entire system	9 m ³ /h	PA5 / 0.01 to 99.9 m ³ /h
Maximum flow rate of the DHW heating	9 m ³ /h	PA5 / 0.01 to 99.9 m ³ /h
Proportional-action coefficient for limitation	1.0	PA5 / 0.1 to 10
By selecting "CONST" additionally		
Maximum flow rate of the heating	9 m ³ /h	PA5 / 0.01 to 99.9 m ³ /h
By selecting "4-Pt" additionally		

Outdoor temperature	Point 1	-15 °C	PA5 /-30 to 90 °C
	Point 2	- 5 °C	
	Point 3	5 °C	
	Point 4	15 °C	
Maximum limit of flow rate, points 1 to 4		9 m ³ /h	PA5 / 0.01 to 99.9 m ³ /h

9.5 LON communication

Note!

The following section only applies to devices with LON interface and CO7 -> Fb00 = ON. On connecting LONMARK devices, CO7 -> Fb00 = OFF needs to be configured.

Each controller is assigned a LON station address, which needs to be set in the PA7 parameter level. A station address in a subnet must be unique. Each controller type is assigned its own subnet. This means that identical LON station addresses can be assigned for different controller types, e.g. 5174 and 5179, as they belong to different subnets. A maximum of 59 participants consisting of TROVIS 5171, 5174, 5177 and 5179 can be connected together.

Controller type	Subnet	Station address
TROVIS 5171	1	1 to 20
TROVIS 5174	4	1 to 20
TROVIS 5177	7	1 to 20
TROVIS 5179	9	1 to 20

The controller sends its inputs and outputs as well as pulse counters and their pulse duration over the LON network to a TROVIS 5171 Programmable Logic Controller.

The pulse inputs are sent after four minutes; the sensor temperatures when the temperature has changed by at least 1 °C or after four minutes at the latest. The analog inputs and outputs are sent when the signal level changes by 0.5 V. The binary inputs and outputs are sent after every change or after four minutes at the latest.

In the InF7 level, all other TROVIS 5100 network participants are listed together with controller type and LON address (e.g. "74-01"). A communication fault exists when the display blinks.

Function	WE	Configuration
LON active	OFF	Co7 -> Fb00 = ON

9.6 Requesting/processing an external demand

Requesting an external demand

The flow temperature set points can be passed on over the LON network in complex heating systems. The external flow set point is compared with the controller's own flow set point. The higher of the two flow set points is passed on.

Functions	WE	Configuration
External demand	OFF	Co5 -> Fb13 = ON
LON active	OFF	Co7 -> Fb00 = ON
Master controller	OFF	Co7 -> Fb01 = OFF

Note!

In systems An1 6 and 9, the setting Co5 -> Fb00 = OFF must be configured for passing on the flow temperature set point. In all other systems, the setting Co5 -> Fb00 = ON must be configured.

Processing an external demand

The master controller receives the demand of connected controllers over the LON network and makes the required energy available for all the control circuits. The secondary flow sensor installed directly downstream of the heat exchanger serves as the sensor for the primary valve. The *Boost* parameter improves the control performance of the connected heating circuit valves and compensates for any loss in capacity.

If an internal heating circuit has the highest set point, the primary valve regulates the temperature at the flow collector to the set point of the heating circuit plus *Boost*.

The set point in the heating circuit is regulated by the mixing valve of the heating circuit. In Inf5 level, the set point of the primary valve appears on the display in this case.

Note! *In systems An1 6 and 9, the external demand is only sent and not processed.*

Functions	WE	Configuration
Flow sensor secondary VFsek	ON	Co5 -> Fb00 = ON
External demand	OFF	Co5 -> Fb13 = ON
	0 °C	Boost / 0 to 30 °C
LON active	OFF	Co7 -> Fb00 = ON
Controller as master controller	OFF	Co7 -> Fb01 = ON

Note!

In controllers with a firmware version lower than 1.05, the master controller receives the Subnet 1 address and node address 1 and is the decisive controller in LON network terms. It is the only controller that can send alarms over a modem.

9.7 Sending outdoor temperatures and controller time

Two outdoor temperatures and the controller time can be sent over the LON bus which are taken on by all the other controllers. Any controller in the system can send these data. Either all the data can be sent by one controller or each piece of data can come from a separate controller. The controller time and the outdoor temperature are transmitted every four minutes. The outdoor temperature is additionally transmitted if it changes by 0.5 °C. All controllers delete the values received over the bus ten minutes after the last update.

Sending the controller time

The controller time can be made available to all LON participants. They download the transmitted time and adopt it. The controller time can be sent with the setting Co7 -> Fb02 = ON. This function should only be set in one LON participant, otherwise various controller times might be sent. In the case that the controller time of the LON participant fails, the controller time continues to run locally in all other participants.

Function	WE	Configuration
Controller time	OFF	Co7 -> Fb02 = ON

Sending outdoor temperatures

Two outdoor temperatures can be sent. By specifying the terminal number after activating the corresponding function block, the sensor is defined whose measured temperature is passed on. The transmitted temperatures are available to all LON participants.

Functions	WE	Configuration
Outdoor temperature 1	OFF	Co7 -> Fb03 = ON Terminal number of outdoor sensor
Outdoor temperature 2	OFF	Co7 -> Fb04 = ON Terminal number of outdoor sensor

Note!

The outdoor temperature used by each LON participant is set on selecting the outdoor sensor (select: FUEHL, 0-10, Lon-1, Lon-2).

10 Installation

The controller consists of the housing with the electronics and the back panel with the terminals. It is suitable for panel, wall, and top hat rail mounting (Fig. 9).

Panel mounting

1. Remove both screws (1).
2. Pull apart the controller housing and back panel.
3. Make a cut-out of 138 x 91 mm (width x height) in the control panel.
4. Insert the controller housing through the panel cut-out.
5. Insert one mounting clamp (2) each at the top and bottom or at the sides. Screw the threaded rod towards the panel with a screwdriver such that the housing is clamped against the control panel.
6. Install the electrical connections at the back of the housing as described in section 11.
7. Fit the controller housing.
8. Fasten both screws (1).

Wall mounting

1. Remove both screws (1).
2. Pull apart the controller housing and back panel.
3. If necessary, bore holes with the specified dimensions in the appropriate places. Fasten the back panel with four screws.
4. Install the electrical connections at the back of the housing as described in section 11.
5. Fit the controller housing.
6. Fasten both screws (1).

Top hat rail mounting

1. Fasten the spring-loaded hook (4) at the bottom of the top hat rail (3).
2. Slightly push the controller upwards and pull the upper hooks (5) over the top hat rail.

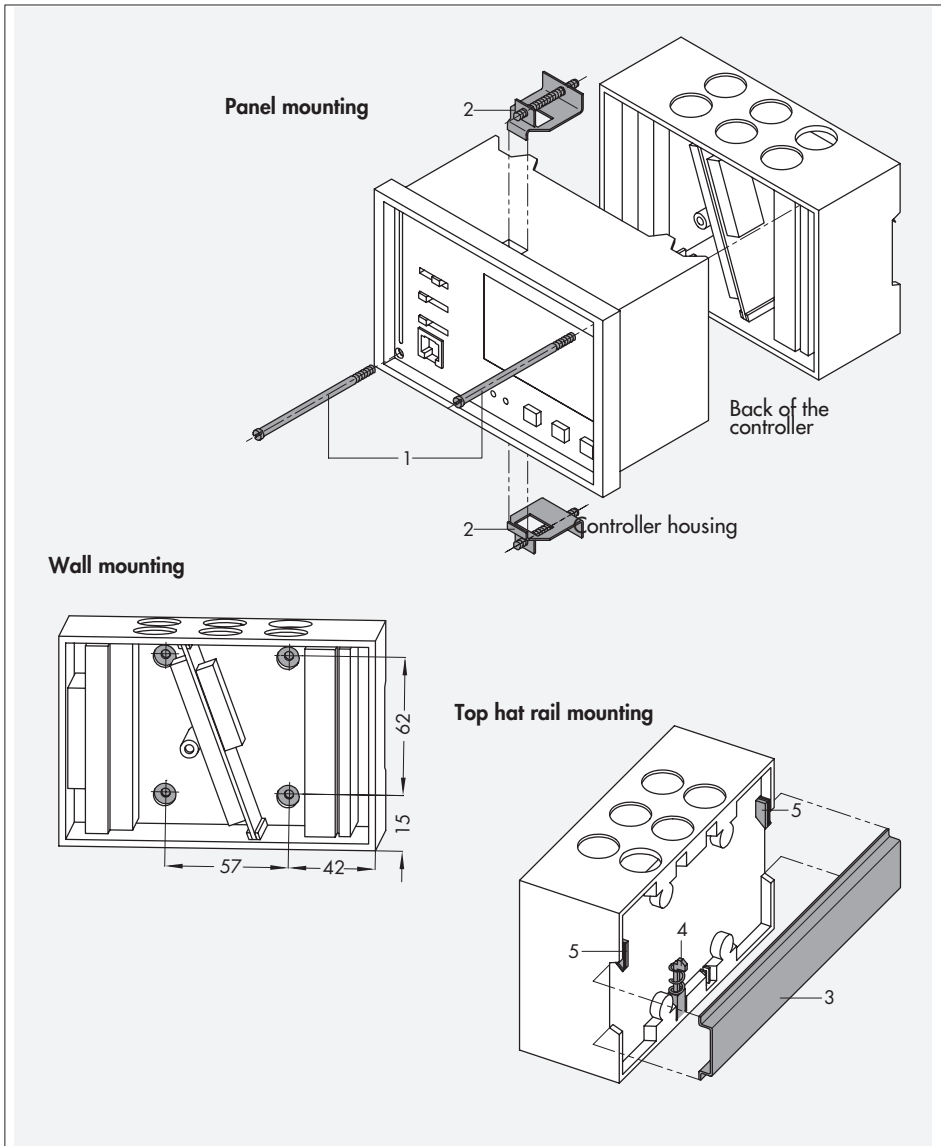

Fig. 9 - Installation

11 Electrical connection

Caution!

For electrical installation, you are required to observe the relevant electrotechnical regulations of the country of use as well as the regulations of the local power suppliers. Make sure all electrical work is performed by trained and experienced personnel!

Notes on installing the electrical connections

- ▶ Install the 230 V power supply lines and the signal lines separately! To increase noise immunity, observe a minimum distance of 10 cm between the lines. Make sure the minimum distance is also observed when the lines are installed in a cabinet.
- ▶ The lines for digital signals (bus lines) and analog signals (sensor lines, analog outputs) must also be installed separately!
- ▶ In plants with a high electromagnetic noise level, we recommend to use shielded cables for the analog signal lines. Ground the shield at one side, either at the control cabinet inlet or outlet, using the largest possible cross-section. Connect the central grounding point and the PE grounding conductor with a cable $\geq 10 \text{ mm}^2$ using the shortest route.
- ▶ Inductances in the control cabinet, e.g. contactor coils, are to be equipped with suitable interference suppressors (RC elements).
- ▶ Control cabinet elements with high field strength, e.g. transformers or frequency converters, should be shielded with separators providing a good ground connection.

Overvoltage protection

- ▶ If signal lines are installed outside buildings or over large distances, make sure appropriate surge or overvoltage protection measures are taken. Such measures are indispensable for bus lines!
- ▶ The shield of signal lines installed outside buildings must have current conducting capacity and must be grounded on both sides.
- ▶ Surge diverters must be installed at the control cabinet inlet.

Connecting the controller

The controller is connected as illustrated in the following wiring diagrams.

If individual inputs for other functions, e.g. for binary inputs, are to be used, they must be determined in the configuration levels (Co1 to Co6).

Open the housing to connect the cables. To connect the feeding cables, make holes in the marked locations at the top, bottom or back of the rear part of the housing and fit suitable cable glands.

Connecting the sensors

Cables with a minimum cross-section of $2 \times 0.5 \text{ mm}^2$ can be connected to the terminals at the back panel of the housing.

Connecting the actuators

Connect cables with at least 1.5 mm^2 suitable for damp locations to the terminals of the controller output. The direction of travel needs to be checked at start-up.

- ▶ Set mode switch to (+). Valves must open.
- ▶ Set slide switch to (-). Valves must close.

Connecting the pumps

Connect all cables with at least 1.5 mm^2 to the terminals of the controller as illustrated in the corresponding connection diagram (-> page 92 to 96).

Wiring plan legend (page 92 to 96):

AA	Analog output 0 to 10 V	VFS	Flow sensor in storage tank
AE	Analog input 0 to 10 V	VFT	Flow sensor in heat exchanger
BA	Binary output	GND	Ground
BA1	UP HK1 ON/OFF	GWx	Limit alarm to terminal x
BA2	UP HK1 Speed reduced	GWy	Limit alarm to terminal y
BA3	UP HK2 ON/OFF	ZB	Meter bus
BA4	UP HK2 Speed reduced	HK	Heating circuit
BE/V	Binary input for flow rate	FW	District heating circuit
AF	Outdoor sensor	TW	DHW circuit
FG	Potentiometer (terminal 3 at Type 5244)	SLP	Storage tank charging pump
RF	Room sensor (terminal 1 at Type 5244)	TLP	Heat exchanger charging pump
RüF	Return flow sensor	UP	Circulation pump
SF	Storage tank sensor (1: Storage tank ON; 2: Storage tank OFF)	ZP	Circulation pump
STh	Storage tank thermostat		
VF	Flow sensor		

Option Type 5244 or 5257-5
(Terminal base of room panel is illustrated)

System Anl 1

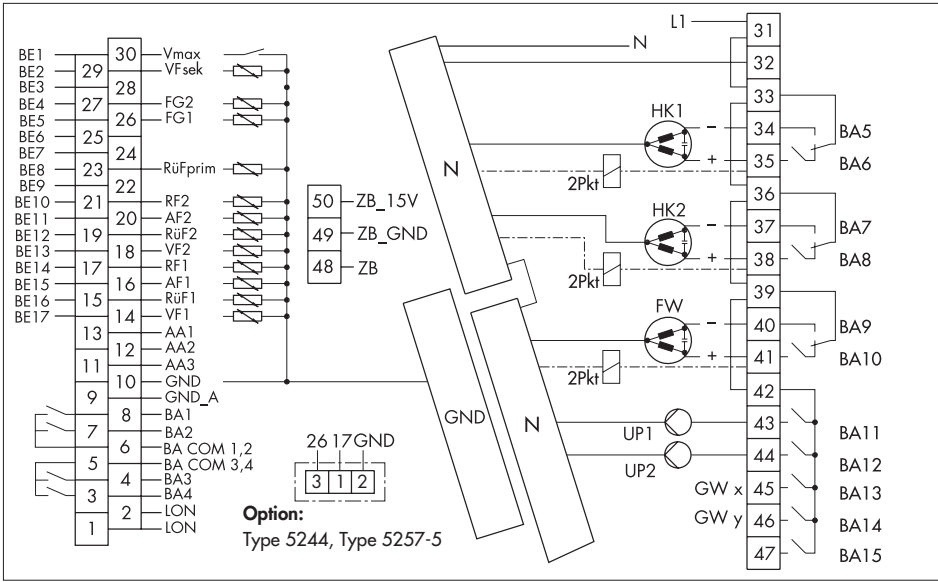

System Anl 2

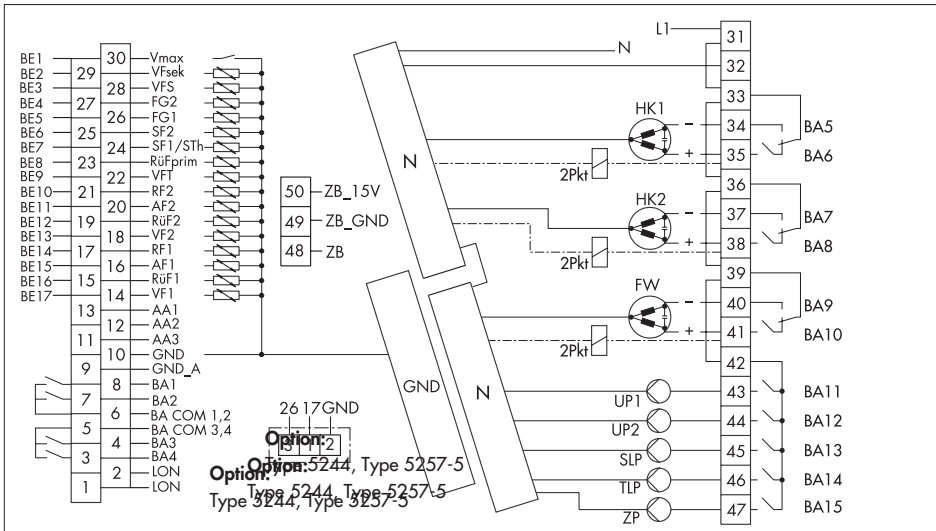

System Anl 3

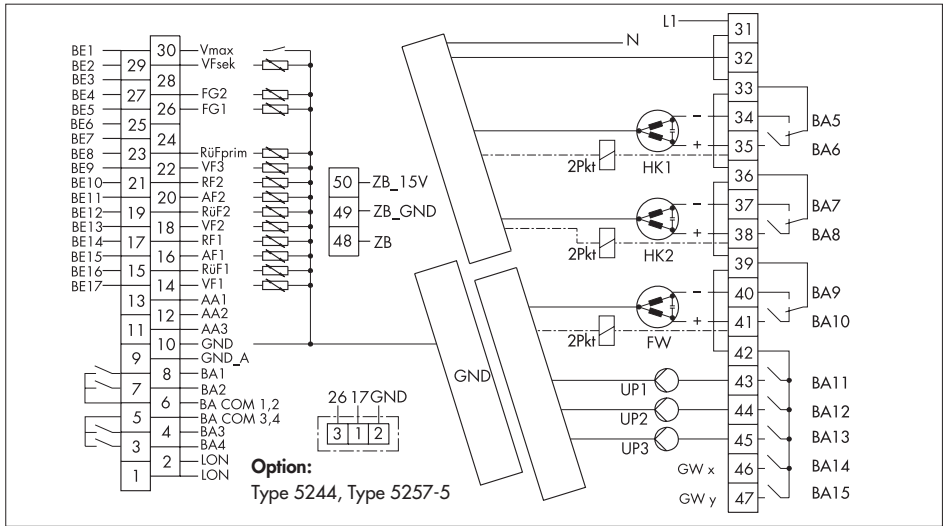

System Anl 4

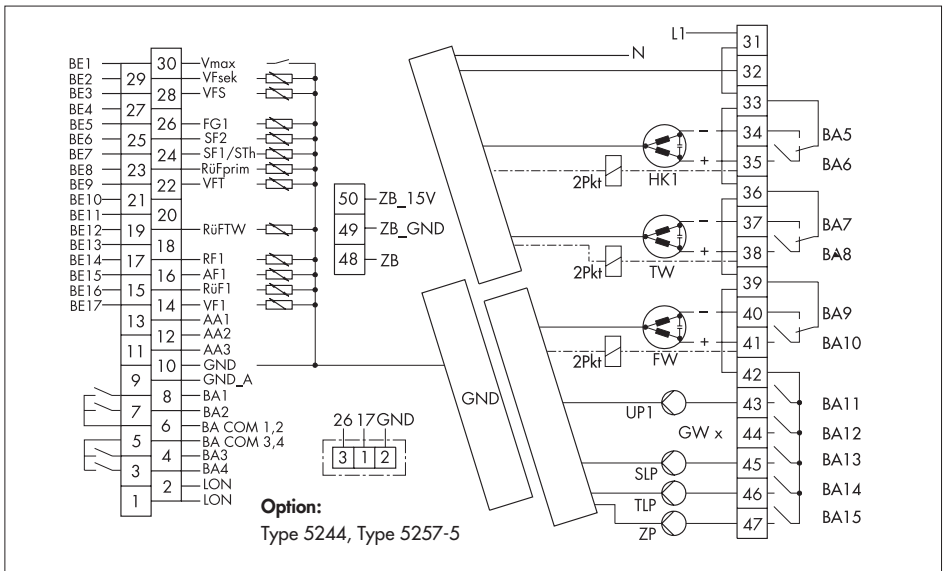

System Anl 5

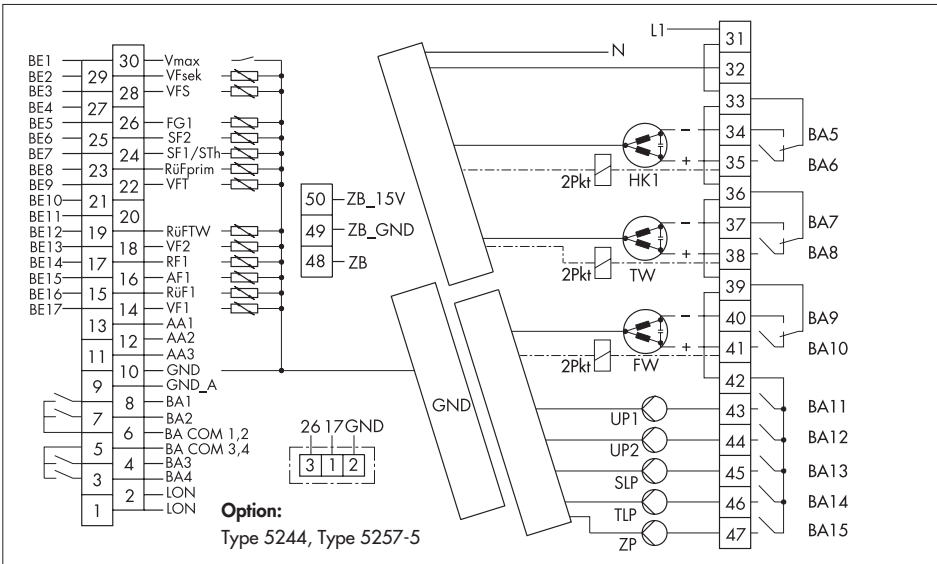

System Anl 6

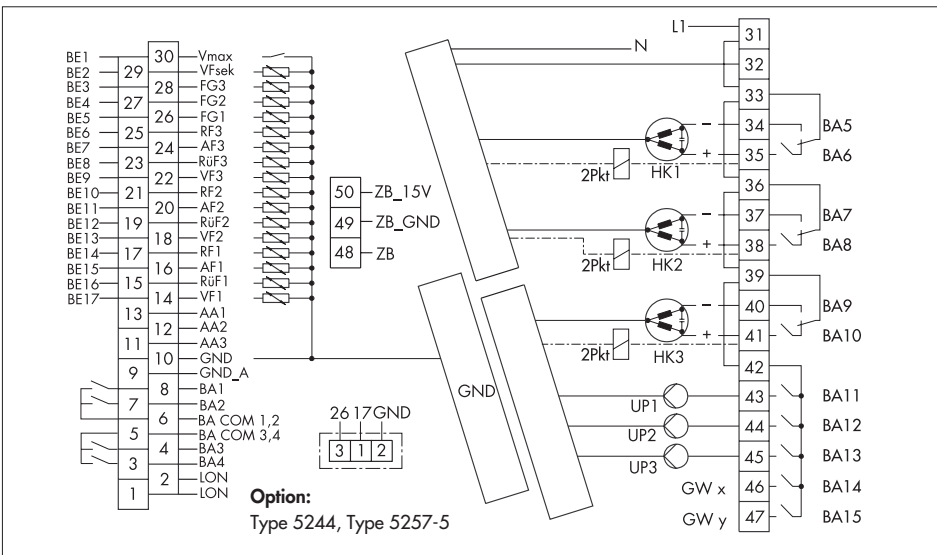

System Anl 7

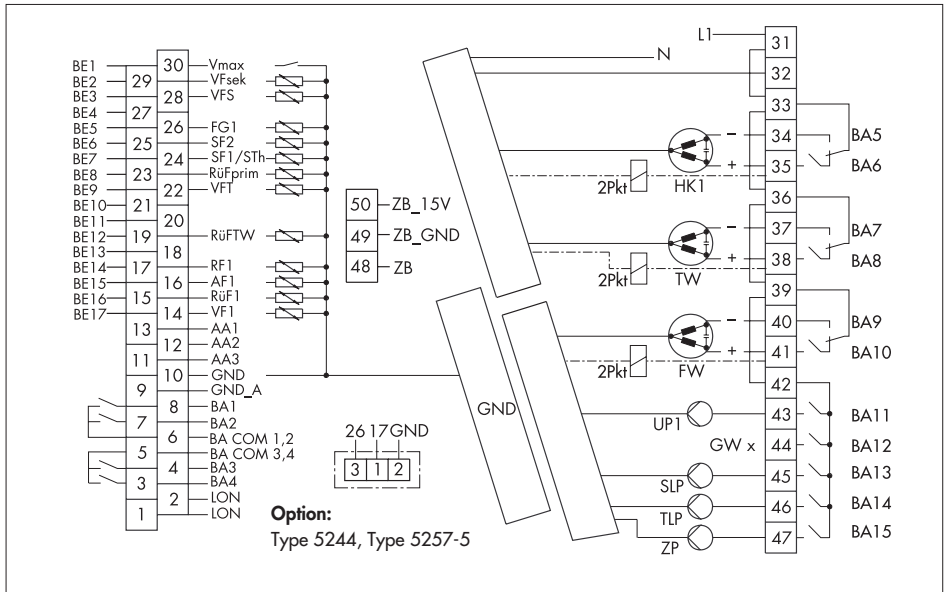

System Anl 8

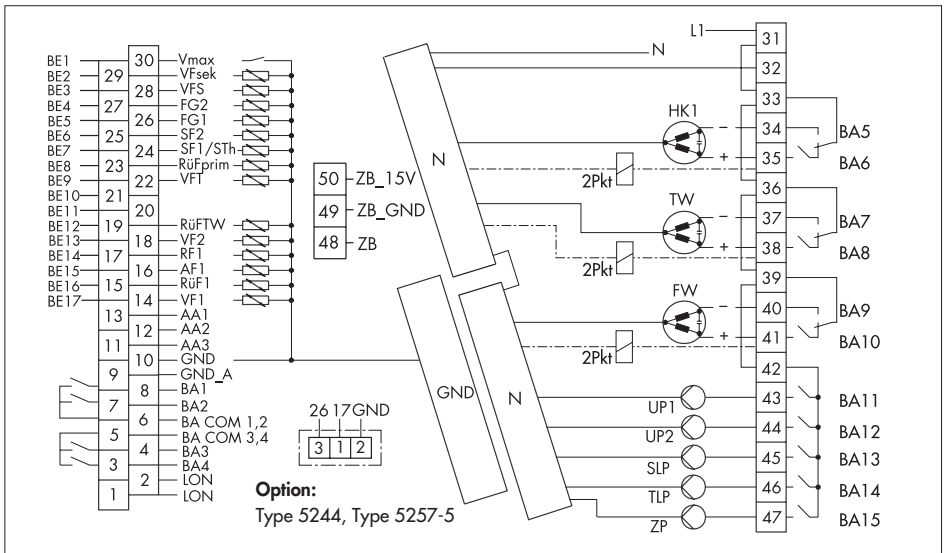

System An1 9

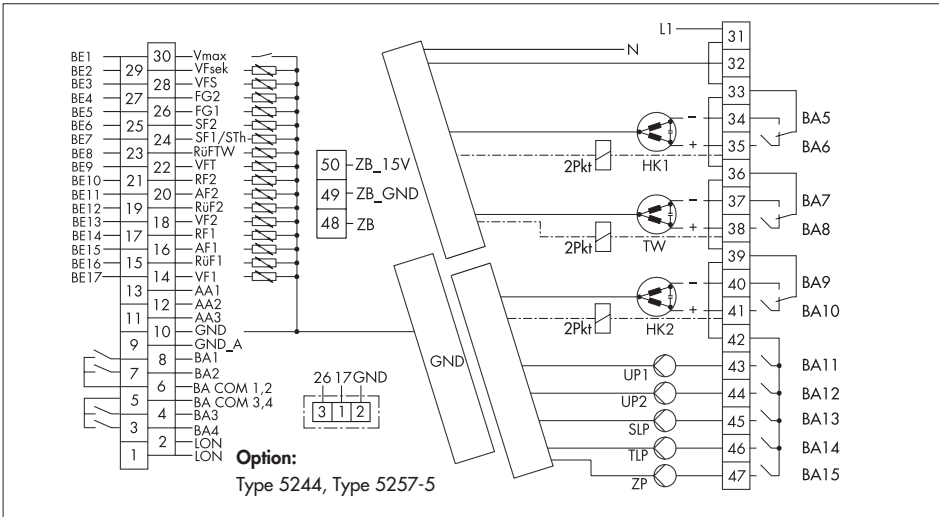

System An1 10

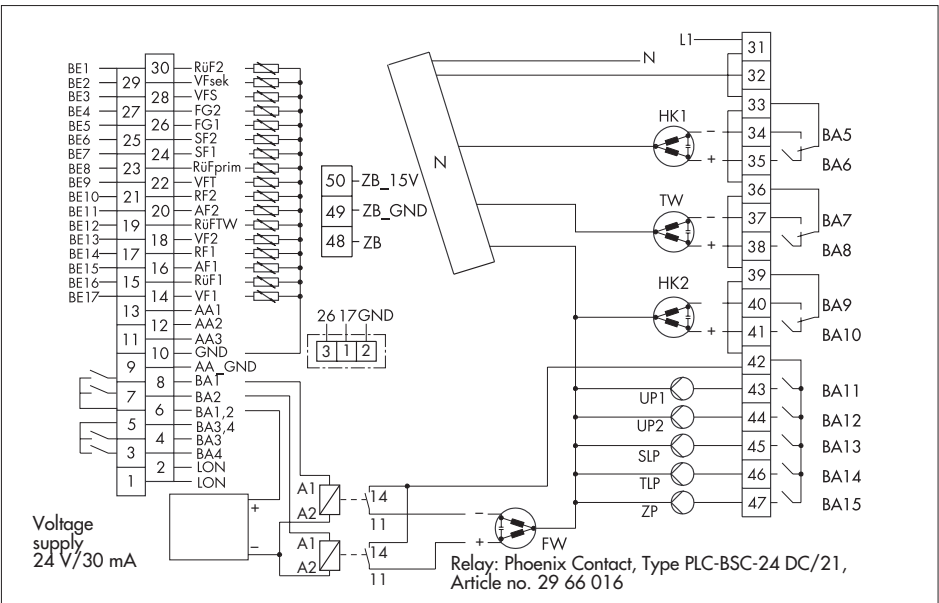

12 Appendix

12.1 Function block lists

Co1 to Co3: Heating circuit 1 to 3

Fb	Function	WE	Anl	Comments Function block parameters / Range of values (default settings)
00	Room sensor RF1, 2, 3	OFF	All	Co1, 2, 3 -> Fb00 = ON: Room sensor active In systems Anl 3, 5 and 8 only for optimization and display
01	Return flow sensor RüF1, 2, 3	OFF	All	Co1, 2, 3 -> Fb01 = ON: Return flow sensor active Function block parameters: Limitation factor / 0 to 25.5 (1.0) In system Anl 6 only after entering key number.
02	Outdoor sensor AF1, 2, 3 * HK1 = ON HK2 = OFF HK3 = OFF	*	All	Co1, 2, 3 -> Fb02 = ON: Outdoor sensor active; Option: Sensor Lon1 Lon2 In HK1 it can only be deactivated when all heating circuits are configured as room temperature-dependent control. The outdoor temperature is then set to the fictive value of 3 °C.
03	Reserved			
04	Reserved			
05	Optimization	OFF	All	Co1, 2, 3 -> Fb05 = ON: Option: 1 Activation according to outdoor temperature; set-back acc. to time schedule* 2 Activation according to outdoor temperature; set-back acc. to room sensor* 3 Activation and deactivation acc. to room sensor * Function block parameters: Advance heating time / 0 to 360 min (120 min) Option 2 and 3 only with Co1, 2, 3 -> Fb00 = ON
06	Room temperature- dependent control	OFF	6, 9	Co1, 2, 3 -> Fb06 = ON: Room temperature-dependent control active
07	Adaptation	OFF	Not 3, 5, 8	Co1, 2, 3 -> Fb07 = ON: Adaptation active; only with Co1, 2, 3 -> Fb00 = ON and Co1, 2, 3 -> Fb10 = OFF
08	Flash adaptation	OFF	Not 3, 5, 8	Co1, 2, 3 -> Fb08 = ON: Flash adaptation active; only with Co1, 2, 3 -> Fb00 = ON

Fb	Function	WE	Anl	Comments Function block parameters / Range of values (default settings)
09	RK switched off when switch at MAN-CLOSED	OFF	All	Co1, 2, 3 -> Fb09 = ON: UP still runs until $1 \times T_Y$. The flow sensor is no longer be read.
10	4-point characteristic	OFF	Not 3, 5, 8, 10	Co1, 2, 3 -> Fb10 = ON: 4-point characteristic Co1, 2, 3 -> Fb10 = OFF: Gradient characteristic
11	Summer mode	ON	All	Co1, 2, 3 -> Fb11 = ON: Function block parameters: Start summer mode / 01.01 to 31.12 (01.05) End summer mode/ 01.01 to 31.12 (30.09) Outdoor temp. limit for summer mode / 0 to 30 °C (18 °C)
12	Potentiometer input Release HK	OFF	All	Co1, 2, 3 -> Fb12 = ON: Valve position feedback (0 to 1000 Ω), 1000 Ω additional resistor required Co1, 2, 3 -> Fb12 = OFF: RK released with binary signal; Option FrG-E: Released over bin. signal (potentiometer) FrG-A: Released over time schedule With FrG-A: RLG: Configuration acc. to input FREE: Input freely available
13	Pump management	OFF	All	Co1, 2 -> Fb13 = ON: BA 2, 4 OFF outside time-of-use Co1, 2 -> Fb13 = OFF: BA 2, 4 ON outside time-of-use
14	Continuous-action control for heating circuit	OFF	All	Co1, 2, 3 -> Fb14 = ON: Continuous-action control 0 to 10 V Function block parameters: K_P (proportional gain) / 0.1 to 50.0 (0.5) T_N (reset time) / 1 to 999 s (200 s) T_V (derivative-action time) / 0 to 999 s (0 s)
15	Three-step control for heating circuit	ON	All	Co1, 2, 3 -> Fb15 = ON: Three-step control; Function block parameters: K_P (proportional gain) / 0.1 to 50.0 (0.5) T_N (reset time) / 1 to 999 s (200 s) T_Y (valve transit time) / 15 to 240 s (120 s) UP lag time / 120 to 1200 s (240 s) Co1, 2, 3 -> Fb15 = OFF: On/off control Function block parameters: Hysteresis / 1 to 30 °C (5 °C) Min. activation time / 0 to 600 s (120 s) Min. deactivation time / 0 to 600 s (120 s) UP lag time / 120 to 1200 s (240 s)
16	Parameter optimization	OFF	6, 9	Co1, 2, 3 -> Fb16 = ON: Automatic parameter optimization (K_P , T_N , T_V)

Fb	Function	WE	Anl	Comments Function block parameters / Range of values (default settings)
17	Flow sensor OFF with room temperature-dependent control	OFF	6, 9	Co1, 2, 3 -> Fb17 = ON: Deactivate flow sensor
18	Differential temperature control using variable weighting factors	OFF	All	Co1, 2, 3 -> Fb18 = ON: Only for mixer circuits Function block parameters: Proportional gain (K_P) / 0.1 to 999 (0.5) Reset time (T_N) / 1 to 999 s (200 s) Intended temp. difference / 0 to 40 °C (20 °C) Analog value max. / 0 to 100 % (90 %) Analog value min. / 0 to 100 % (30 %)

Fb Function block, WE Default setting

Co4: DHW heating

Fb	Function	WE	Anl	Comments Function block parameters / Range of values (default setting)
00	Storage tank sensor SF1	ON	Not 1, 3, 6	Co4 -> Fb00 = OFF, only with storage tank thermostat: Co4 -> Fb00 = OFF and Co4 -> Fb01 = OFF
01	Storage tank sensor SF2	ON	Not 1, 3, 6	Co4 -> Fb01 = ON: 2 storage tank sensors SF1 and SF2 Co4 -> Fb01 = OFF: 1 storage tank sensor SF1 or with Co4 -> Fb00 = OFF: Storage tank thermostat
02	Return flow sensor DHW circuit	OFF	Not 1, 2, 3, 6	Co4 -> Fb02 = ON: Return flow sensor in DHW circuit active Function block parameters: Limitation factor / 0 to 25.5 (1.0) Note: Can only be changed after entering the key number
03	Flow sensor VFS	ON	Not 1, 3, 6	Co4 -> Fb03 = ON: Charging temperature limited with VFT, regulated with VFS Co4 -> Fb03 = OFF: Charging temperature regulated with VFT, without VFS
04	Circulation pump	OFF	Not 1, 3, 6	Co4 -> Fb04 = ON: ZP continues to run during storage tank charging Co4 -> Fb04 = OFF: ZP runs acc. to time schedule
05	UP OFF at the start of reverse control	OFF	5	Co4 -> Fb05 = ON: UP of pump heating circuit is additionally switched off when reverse control starts.

Fb	Function	WE	Anl	Comments Function block parameters / Range of values (default setting)
06	Reverse control	ON	Not 1, 3, 6	Co4 -> Fb06 = ON: Reverse control Co4 -> Fb06 = OFF: Set-back operation Function block parameters: Activate priority in case of deviation / 0 to 30 °C (0 °C)
07	Time until reverse control	ON	Not 1, 2, 3, 6	Co4 -> Fb07 = ON: Reverse control after 2 minutes Co4 -> Fb07 = OFF: Reverse control after 10 minutes
08	Thermal disinfection	OFF	Not 1, 3, 6	Co4 -> Fb08 = ON: Function block parameters: Day of the week / 0 = daily, 1 = Monday, 2, ..., 7 (3 = Wednesday) Disinfection temperature / 60 to 90 °C (70 °C) Charging boost / 0 to 30 °C (5 °C) Start time / 00:00 to 23:30 h (00:00 h) Stop time / 00:00 to 23:30 h (04:00 h)
09	Three-point stepping control for DHW heating	ON	Not 1, 2, 3, 6	Co4 -> Fb09 = ON: Function block parameters: K _P (proportional gain) / 0.1 to 50.0 (0.5) T _N (reset time) / 1 to 999 s (200 s) T _V (valve transit time) / 15 to 240 s (120 s)
10	Storage tank system	OFF	Not 1, 3, 6	Co4 -> Fb10 = ON: DHW heating in storage tank system
11	Mixing valve always active	OFF	Not 1, 3, 6	Co4 -> Fb11 = ON: Heating maintained to prevent circulation losses
12	Public holiday and vacation data apply to DHW circuit	OFF	Not 1, 3, 6	Co4 -> Fb12 = ON: Function block parameter: Data for heating circuit / 1 to 3 (1)
13	Condensate accumulation control		7, 8	Co4 -> Fb13 = ON: Function block parameter: Maximum system deviation / 2 to 10 °C (2 °C) For all other systems (Anl) enter under Co5 -> Fb07
14	Continuous-action control DHW heating	OFF	Not 1, 3, 6	Co4 -> Fb14 = ON: Continuous-action control 0 to 10 V Function block parameters: K _P (proportional gain) / 0.1 to 50.0 (0.5) T _N (reset time) / 1 to 999 s (200 s) T _V (derivative-action time) / 0 to 999 s (0 s)

Fb Function block, WE Default setting

Co5: General functions and pre-control circuit

Fb	Function	WE	Anl	Comments Function block parameters / Range of values (default setting)
00	Flow sensor secondary VFsek	ON	All	Co5 -> Fb00 = ON: In systems Anl 6 and 9 not possible with Co5 -> Fb06 = ON
01	Return flow sensor primary	ON	Not 6, 9	Co5 -> Fb01 = ON: Return flow limitation active, Option steig Limitation acc. to gradient characteristic 4-pt Limitation acc. to 4-point characteristic Note: Can only be changed after entering key number
02	Reserved	OFF	All	
03	4-point characteristic	OFF	3, 5, 8, 10	Co5 -> Fb03 = ON: 4-point characteristic Co5 -> Fb03 = OFF: Gradient characteristic Setting applies for all heating circuits.
04	Delayed outdoor temperature adaptation	OFF	All	Co4 -> Fb04 = ON: Option Ab When outdoor temperature drops AufAb When outdoor temperature drops or rises Function block parameter: Delay / 1 to 6 °C/h (3 °C/h)
05	Summer time/winter time changeover	ON	All	Co4 -> Fb05 = ON: Automatic summer time/winter time changeover
06	Compensation of time delays	OFF	1, 2, 4, 7, 10	Co5 -> Fb06 = ON: Only with Co5 -> Fb00 = ON
07	Condensate accumulation control	OFF	All	Co5 -> Fb07 = ON: Only with Co5 -> Fb14 = ON Function block parameter: Maximum system deviation / 2 to 10 °C (2 °C)
08	Limitation of WMZ	OFF	Not 6, 9	Co5 -> Fb08 = ON: Select limitation, depending on Co9 -> Fb21 to Fb23 ---: No limitation U: Flow rate limitation P: Capacity limitation U-P: Flow rate and capacity limitation when "U", "P" or "U-P" is selected: CONST: Limitation constant 4-Pt: Limitation acc. to 4-point characteristic, dependent on outdoor temperature Note: Can only be changed after entering key number

Fb	Function	WE	Anl	Comments Function block parameters / Range of values (default setting)
09	Pulse input for flow rate or capacity limitation	OFF	Not 6, 9	Co5 -> Fb09 = ON: Type of limitation Option: U: Flow rate limitation P: Capacity limitation CONST Limitation constant 4-Pt: Limitation acc. to 4-point characteristic Function block parameter: Pulse weighting / 0.1 to 10 (10) Note: Can only be changed after entering key number
10	Locking manual levels	OFF	All	Co5 -> Fb10 = ON: Manual intervention not possible and parameters cannot be changed Note: Can only be changed after entering key number
11	Limit monitoring of a selected sensor input x	OFF	All	Co5 -> Fb11 = ON: Function block parameters: Terminal number Upper/lower limit Signal edge, binary output FSr-A/FSr-E: Status alarm to error status register OFF/ON BA ON/BA OFF: Setting/not setting the binary input FALL/steig: Negative signal edge/increasing signal edge
12	Limit monitoring of a selected sensor input y	OFF	All	Co5 -> Fb12 = ON: Function block parameters: Terminal number Upper/lower limit Signal edge, binary output FSr-A/FSr-E: Status alarm to error status register OFF/ON BA ON/BA OFF: Setting/not setting the binary input FALL/steig: Negative signal edge/increasing signal edge
13	External demand	OFF	Not 3, 5, 8	Co5 -> Fb13 = ON: The highest set point is passed on; (only with Fb00 = ON possible, in systems Anl 6 and 9 Fb00 = OFF) Function block parameter: Boost / 0 to 30 °C (0 °C) In systems Anl 6 and 9 the demand can only be sent

Co6: Sensor initialization

Fb	Function	WE	Anl	Comments Function block parameters / Range of values (default setting)
00	Sensor selection general	ON	All	Co6 -> Fb00 = ON: Pt 100; Pt 1000 Co6 -> Fb00 = OFF: Pt 100; PTC
01 to 17	Sensor input 1 to sensor input 17	OFF	All	Any sensor inputs that are different from the settings for function block Fb00 Co6 -> Fb01 to Fb17 = ON: select: Outdoor temperature input: 0/4 to 20 mA, 0 to 10 V = -40 to 50 °C Other temperature inputs: 0/4 to 20 mA, 0 to 10 V = 0 to 160 °C Ni200, Ni1000, PTC, NTC, Pt1000, Pt100, 0/4-20, 0-10
23	Sensor calibration	OFF	All	

Fb Function block, WE Default setting

Co7: LON communication

Fb	Function	WE	Anl	Comments Function block parameters / Range of values (default setting)
00	LON active	OFF	All	Co7 -> Fb00 = ON: LON interface active
01	Controller as master controller	OFF	All	Co7 -> Fb01 = ON: Controller is defined as primary controller (processes the external demand as master controller) Co7 -> Fb01 = OFF: Controller is defined as secondary controller
02	Controller time	OFF	All	Co7 -> Fb02 = ON: Controller time = LON system time
03	Outdoor temperature 1	OFF	All	Co7 -> Fb03 = ON: LON outdoor temperature 1 Select: Terminal number of outdoor sensor
04	Outdoor temperature 2	OFF	All	Co7 -> Fb04 = ON: LON outdoor temperature 2 Select: Terminal number of outdoor sensor
05	Report operational faults of other LON participants	OFF	All	Co7 -> Fb05 = ON: Report fault alarms of other LON participants

Fb Function block, WE Default setting

Co8: Error initialization

Fb	Function	WE	Anl	Comments Function block parameters / Range of values (default setting)
00	Dial-up also upon corrected fault	OFF	All	CO8 -> Fb00 = ON: Dial-up to the building control station both when a fault was detected and a fault was corrected CO8 -> Fb00 = OFF: Dial-up to building control station only when fault was detected
01 to 17	BE1 in FSr to BE 17 in FSr	OFF	All	Co8 -> Fb01 to Fb17 = ON: Option: Rising signal edge/make contact Negative signal edge/break contact Note: Can only be changed after entering key number
22	Limit monitoring	OFF	All	Configurable over Modbus
23	Alarm binary input changed	OFF	All	Co8 -> Fb23 = ON: Subsequent faults reported in error status register (bit D11)

Fb Function block, WE Default setting

Co9: Modbus and meter bus communication

Fb	Function	WE	Comments Function block parameters / Range of values (default setting)
00	Modbus	ON	CO9 -> FB00 = ON: Modbus active
01	Modem	OFF	CO9 -> FB01 = ON: Modem active
02	Modem dialing mode	OFF	CO9 -> FB02 = ON: Pulse dialing CO9 -> FB02 = OFF: Tone dialing
03	Lock dial-up	OFF	CO9 -> FB03 = ON: No dial-up in case of fault
04	Modbus 16-bit addressing	OFF	CO9 -> Fb04 = ON: 16-bit addressing CO9 -> Fb04 = OFF: 8-bit addressing
05	Reserved		
06	Text message alarm	OFF	CO9 -> FB06 = ON: Fault alarm sent to mobile phone
07	Text message dialing mode	OFF	CO9 -> FB07 = ON: Pulse dialing CO9 -> FB07 = OFF: Tone dialing
10	Fax alarm	OFF	CO9 -> FB10 = ON: Alarm sent to fax
11	Fax dialing mode	OFF	CO9 -> FB11 = ON: Pulse dialing CO9 -> FB11 = OFF: Tone dialing

FB Function		Comments	
		WE	Function block parameters / Range of values (default setting)
21 to 23	Meter bus #1 to Meter bus #3	OFF	CO9 -> Fb21, 22, 23 = ON: Function block parameters: Meter bus address WMZ_ / 0 to 255 (255) Model code WMZ_ / P15, PS2, 1434, CAL3, APAtO, SLS (1434) Reading mode WMZ_ / 24h, con, Coil (con)

Fb Function block, WE Default setting

12.2 Parameter list

PA1 to PA3: Heating circuits HK1 to HK3

Display

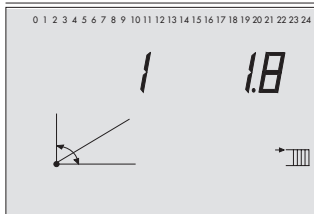

Parameter designation

Range of values (default settings)

Gradient of the heating characteristic, flow

0.4 to 3.2 (1.8)

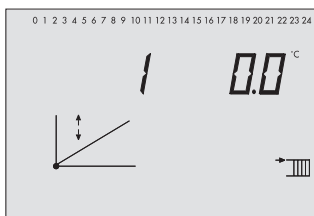

Level of the heating characteristic, flow

-30 to 30 °C (0 °C)

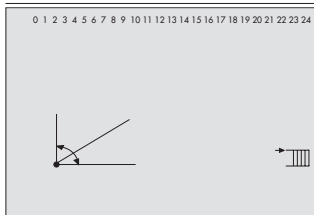

4-point characteristic

☒ Press key to adjust the following parameters:
 outdoor temperature,
 flow temperature,
 return flow temperature and
 set-back difference.

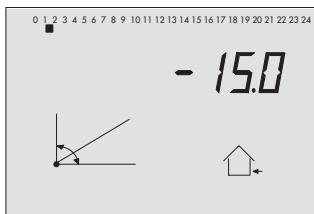

4-point characteristic

Point 1: Outdoor temperature

Outdoor temperatures of the points 2, 3, 4 are marked by squares below the numbers 2, 3, 4.

-30 to 90 °C

(point 1 = -15 °C, point 2 = -5 °C, point 3 = 5 °C, point 4 = 15 °C)

Display

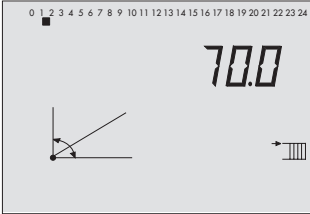

Parameter designation

Range of values (default settings)

4-point characteristic

Point 1: Flow temperature

Flow temperatures of the points 2, 3, 4 are marked by squares below the numbers 2, 3, 4.

20 to 130 °C

(point 1 = 70 °C, point 2 = 55 °C, point 3 = 40 °C, point 4 = 25 °C)

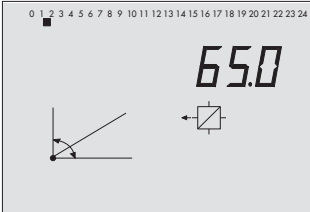

4-point characteristic

Point 1: Return flow temperature

Return flow temperatures of the points 2, 3, 4 are marked by squares below the numbers 2, 3, 4.

20 to 90 °C

(point 1 = 65 °C, point 2 = 50 °C, point 3 = 35 °C, point 4 = 20 °C)

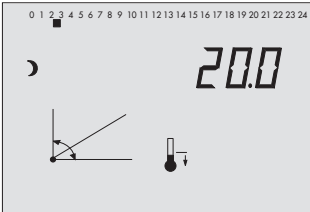

4-point characteristic Set-back difference

Varying set-back differences can be entered for the second and third points. The corresponding point is marked by squares below the numbers 2 and 3.

0 to 50 °C (20 °C)

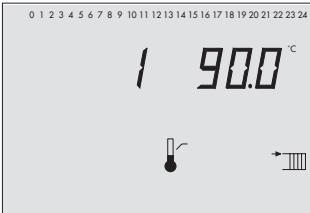

Maximum flow temperature

20 to 130 °C (90 °C)

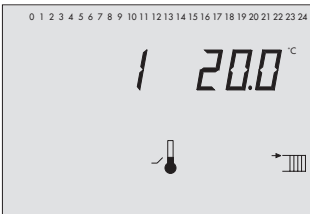

Minimum flow temperature

20 to 130 °C (20 °C)

Control according to fixed set point:

Min. return flow temperature = Max. return flow temperature

Display

Parameter designation

Range of values (default settings)

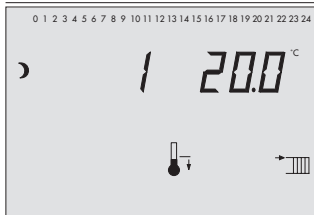

Set-back difference

0 to 50 °C (20 °C)

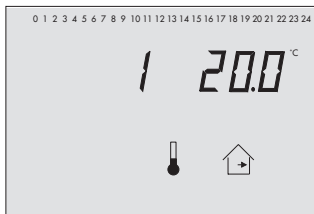

Day set point

10 to 90 °C (20 °C)

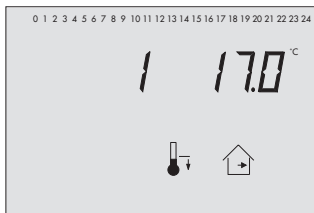

Night set point

10 to 90 °C (17 °C)

Optimization 2, 3

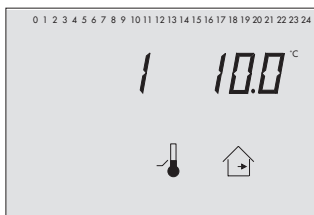

Sustained temperature

10 to 90 °C (10 °C)

Optimization 3

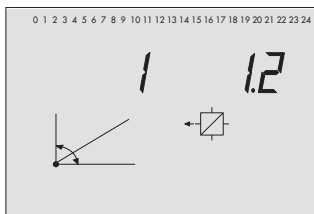

Gradient of the heating characteristic, return flow

0.4 to 3.2 °C (1.2)

Only with Co1, 2, 3 -> Fb10 = OFF

Display

Parameter designation

Range of values (default settings)

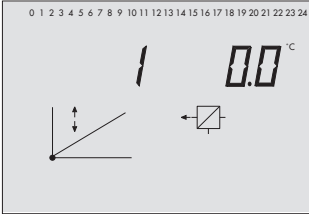

Level of the heating characteristic, return flow

-30 to 30 °C (0 °C)

Characteristic is shifted parallel.

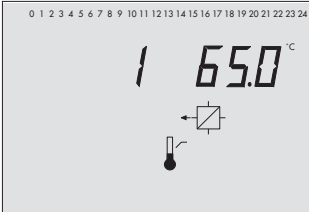

Max. return flow temperature

20 to 90 °C (65 °C)

Only with Co5 -> Fb01 = ON, **select:** steig

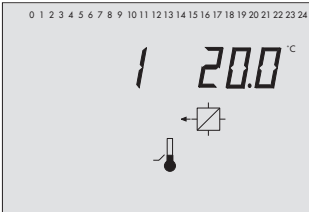

Min. return flow temperature

20 to 90 °C (20 °C)

Only with Co5 -> Fb01 = ON, **select:** steig

Control according to fixed set point:

Min. return flow temperature = Max. return flow temperature

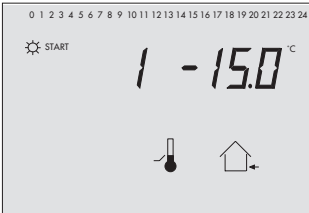

OT activation value in rated operation

-30 to 50 °C (-15 °C)

The heating continues to run and is not set back outside the time-of-use when the outdoor temperature is below the OT limit.

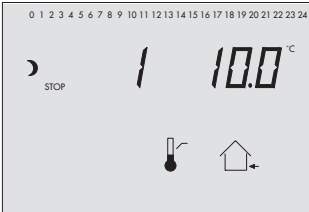

OT deactivation value in reduced operation

-10 to 50 °C (10 °C)

The heating is switched off outside the time-of-use when the outdoor temperature is above the OT limit.

Display

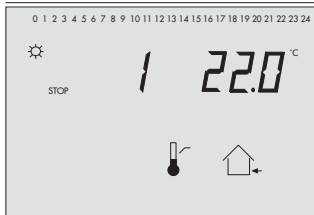

Parameter designation

Range of values (default settings)

OT deactivation value in rated operation

0 to 90 °C (22 °C)

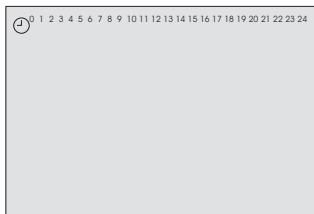

Times-of-use

Freely configurable (daily 7:00 to 24:00 h)

-> Section 1.6

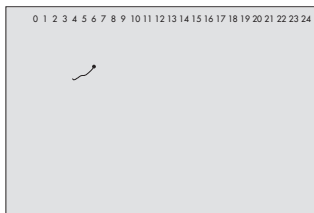

Public holidays

Freely configurable

-> Section 1.6

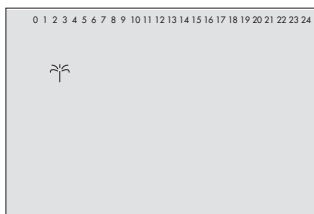

Vacations

Freely configurable

-> Section 1.6

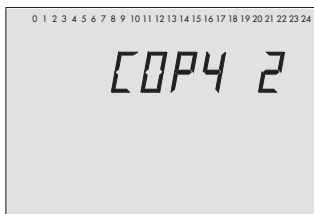

Copy times-of-use of HK1 for HK2

Only in systems An1, 2, 3, 5, 6, 7, 8, 9, 10

Display

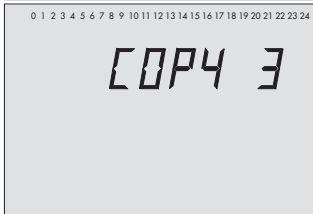

Parameter designation

Range of values (default settings)

Copy times-of-use of HK2 for HK3

Only in systems An1 3, 6

PA4: DHW heating

Display

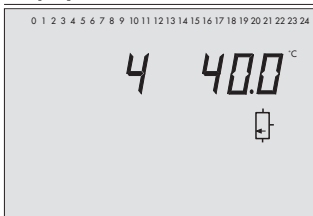

DHW demand ON

20 to 90 °C (40 °C)

Systems with a storage sensor SF1
Co4 -> Fb02 = ON , Fb02 = OFF

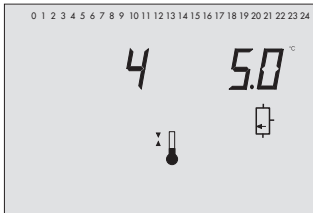

Hysteresis

0 to 30 °C (5 °C)

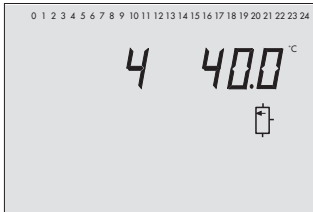

DHW demand ON

20 to 90 °C (40 °C)

Systems with two storage sensors SF1 and SF2
Co4 -> Fb02 = ON , Fb02 = ON

Display

Parameter designation

Range of values (default settings)

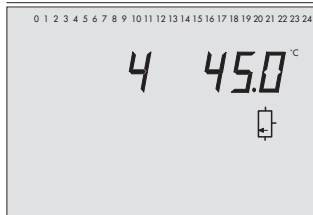

DHW demand OFF

20 to 90 °C (45 °C)

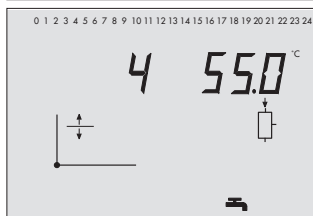

Charging temperature

20 to 90 °C (55 °C)

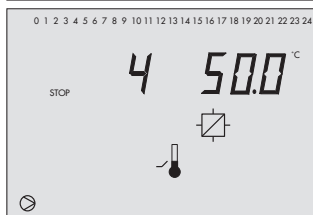

Heat exchanger charging pump, deactivation limit

20 to 90 °C (50 °C)

Lag of heat exchanger charging pump until the heat exchanger flow temperature falls below the limit.

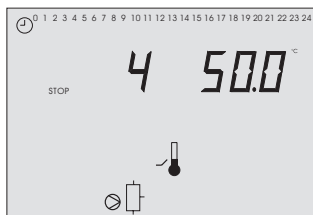

Storage tank charging pump, deactivation limit

20 to 90 °C (50 °C)

Lag of storage tank charging pump until the heat exchanger flow temperature falls below the limit.

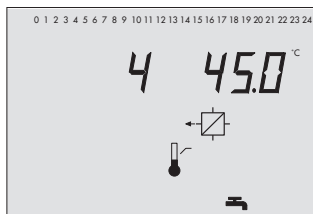

Return flow limitation temperature for DHW

20 to 90 °C (45 °C)

Display

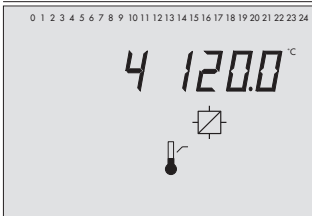

Parameter designation

Range of values (default settings)

Maximum charging temperature

20 to 120 °C (120 °C)

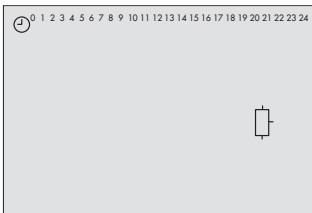

Time schedule of DHW heating

00:00 to 24:00 h

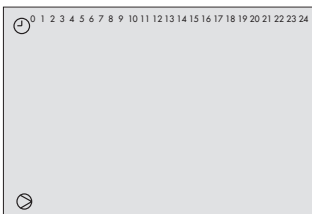

Time schedule of circulation pump

00:00 to 24:00 h

PA5: Capacity and flow rate limitation

Display

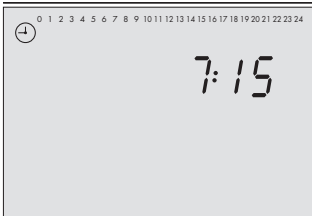

Parameter designation

Range of values (default settings)

Time

00:00 to 24:00 h

Display

Parameter designation

Range of values (default settings)



Date (day.month)

01.01 to 31.12

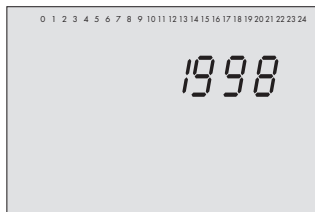

Date (year)

Freely configurable

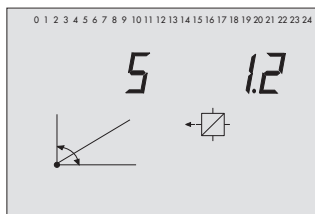

Gradient of the heating characteristic, return flow

0.4 to 3.2 (1.2)

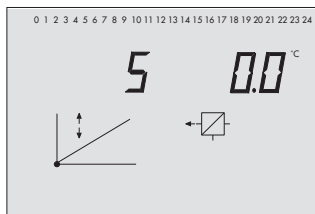
Only with Co5 -> Fb01 = ON, **select:** steig

Level of the heating characteristic, return flow

-30 to 30 °C (0 °C)

Characteristic is shifted parallel.

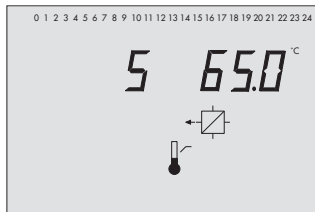

Maximum return flow temperature

20 to 90 °C (65 °C)

Only with Co5 -> Fb01 = ON, **select:** steig

Display

Parameter designation

Range of values (default settings)

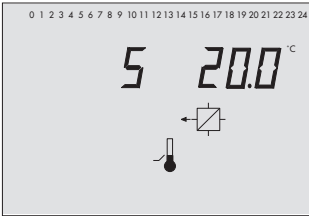

Minimum return flow temperature

20 to 90 °C (20 °C)

Only with Co5 -> Fb01 = ON, **select:** steig

Control according to fixed set point:

Min. return flow temperature = Max. return flow temperature

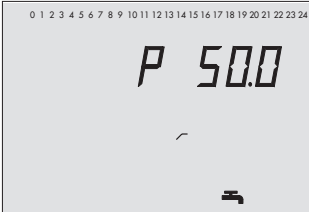

Maximum capacity of the entire system

0.1 to 5999 kW (50 kW)

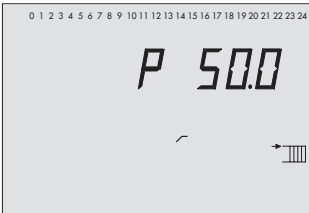

Maximum capacity of the heating

0.1 to 5999 kW (50 kW)

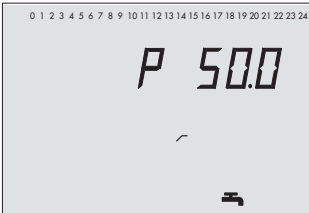

Maximum capacity of the DHW heating

0.1 to 5999 kW (50 kW)

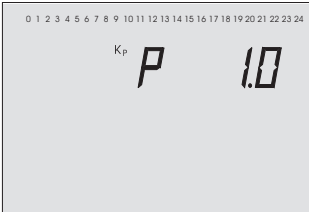

Proportional-action coefficient for the limitation

0.1 to 10 (1.0)

Display

Parameter designation

Range of values (default settings)

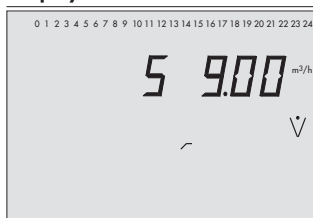

Maximum flow rate of the entire system

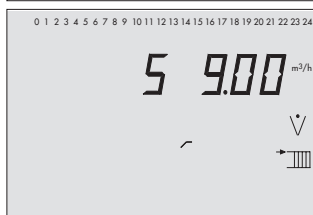
0.01 to 99.9 m³/h (9 m³/h)

Maximum flow rate of the heating

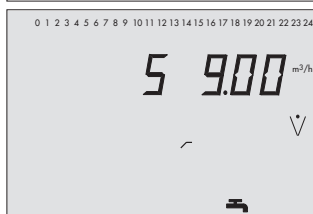
0.01 to 99.9 m³/h (9 m³/h)

Maximum flow rate of the DHW heating

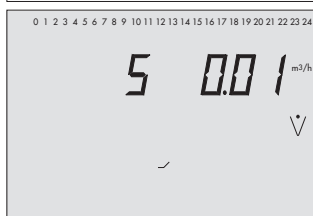
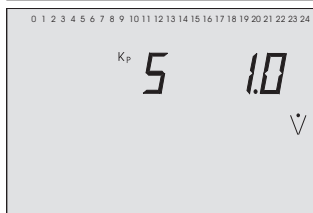
0.01 to 99.9 m³/h (9 m³/h)Minimum flow rate
(creep limitation)0.01 to 99.9 m³/h (0.01 m³/h)

Proportional-action coefficient for the limitation

0.1 to 10 (1.0)

Display

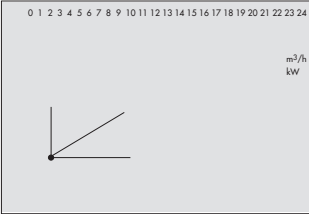

Parameter designation

Range of values (default settings)

4-point characteristic

☒ Press key to adjust the following parameters:
 outdoor temperature,
 return flow temperature (see page 108),
 maximum flow rate or maximum capacity.

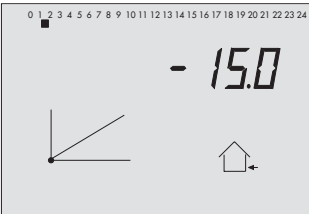

4-point characteristic:

Point 1: Outdoor temperature
 Outdoor temperatures of the points 2, 3, 4 are marked by squares below the numbers 2, 3, 4.

-30 to 90 °C
 (point 1 = -15 °C, point 2 = -5 °C, point 3 = 5 °C, point 4 = 15 °C)

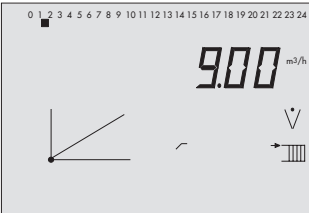

4-point characteristic:

Point 1: Maximum limit of the flow rate
 Limits of the points 2, 3, 4 are marked by squares below the numbers 2, 3, 4.

0.01 to 99.9 m³/h
 (point 1 to point 4 = 9 m³/h)

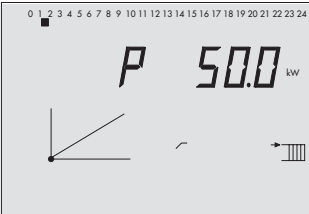

4-point characteristic

Point 1: Maximum limit of the capacity
 Limits of the points 2, 3, 4 are marked by squares below the numbers 2, 3, 4.

0.1 to 5999 kW
 (point 1 to point 4 = 50 kW)

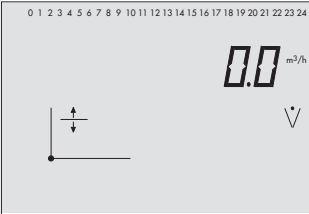

V-offset of the entire system

-300 to 300 m³/h (0.0 m³/h)

Display

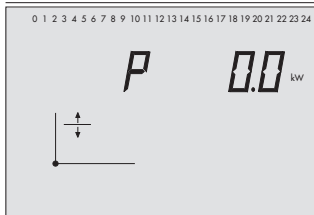

Parameter designation

Range of values (default settings)

P-offset of the entire system

-3000 to 3000 kW (0.0 kW)

PA9: Communication

Display

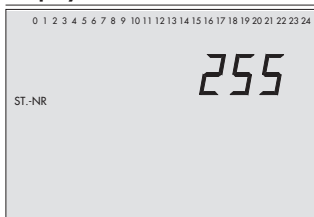

Parameter designation

Range of values (default settings)

Station address (ST.-NR)

1 to 247 (255)

1 to 999 (255) with Co9 -> Fb04 = ON

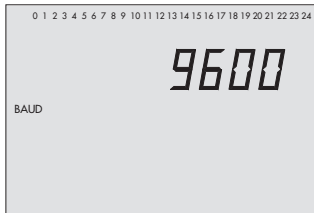

Baud rate (BAUD)

300 to 19200 (9600)

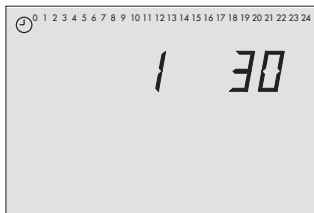

Cyclic initialization (I)

0 to 255 min (30 min)

Display

Parameter designation
Range of values (default settings)

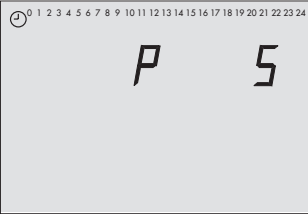

Modem dialing pause (P)
1 to 255 min (5 min)

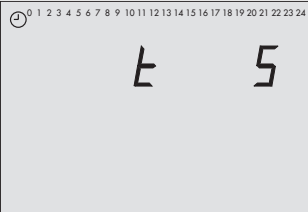

Modem timeout (t)
1 to 255 min (5 min)

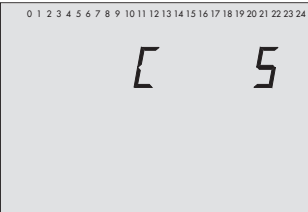

Number of dialing attempts (C)
0 to 99 (5)

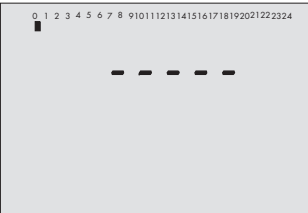

Co9 -> Fb01 = ON:
Phone number of control station (tELno)/alternative recipient (rESno)
Co9 -> Fb06 = ON:
D1 access number (UGno)/mobile phone number (HAndY)
Co9 -> Fb10 = ON:
Fax number (tELno)/Station ID (St Id)
Max. 22 or 14 characters: 0 to 9
P = Pause, - = End of number

12.3 Display

The following displays are typical displays that can appear.

Icons at the edge of the display may vary depending on the operating mode and how the controller is configured; they cannot be shown in this case.

Inf1 to Inf3: Heating circuits HK1 to HK3

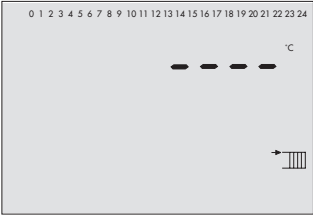
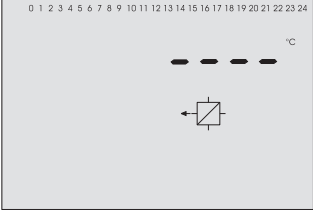
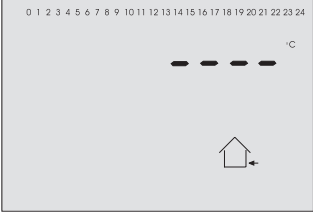
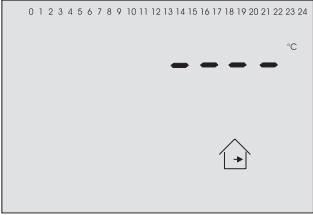
Display	Parameter designation
	<p>Current flow temperature at VF1, VF2, VF3</p> <p>✳ Press enter key to confirm. The set point is displayed.</p>
	<p>Current return flow temperature at RüF1, RüF2, RüF3</p> <p>✳ Press enter key to confirm. The set point is displayed.</p> <p>When the function for differential temperature control using variable weighting factors without return flow temperature limitation is active, "s-r" also appears on the display.</p>
	<p>Current outdoor temperature</p> <p>✳ Press enter key to confirm. The set point is displayed.</p>
	<p>Current room temperature</p> <p>✳ Press enter key to confirm. The set point is displayed.</p>

Display

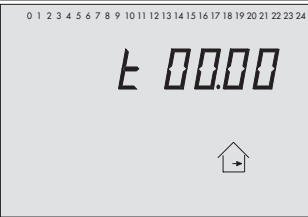

Parameter designation

Tendency of the room temperature

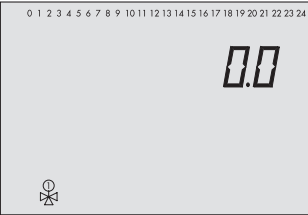

Valve position

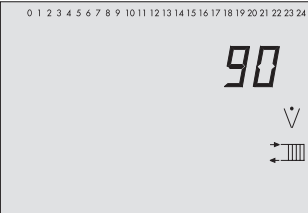

The actual value of the analog output with differential temperature control using variable weighting factors

- Press enter key to confirm.
The set point is displayed.

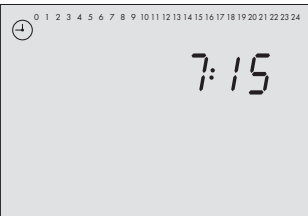

Time

- Press enter key to confirm.
The time-of-use for Monday (1) is displayed.
- Press arrow key to scroll between times-of-use for the other days of the week.

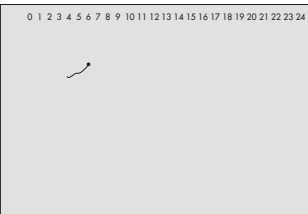

Public holidays

- Press enter key to confirm.
The first programmed public holiday is displayed.
- Press arrow key to scroll between further programmed public holidays.

Display

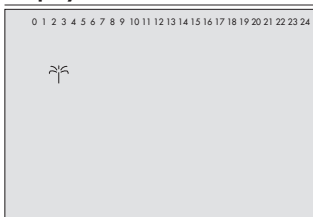

Parameter designation

Vacations

- Press enter key to confirm..
The first vacation period is displayed.
- Press arrow key to scroll between other vacation periods.

Inf4: DHW heating

Display

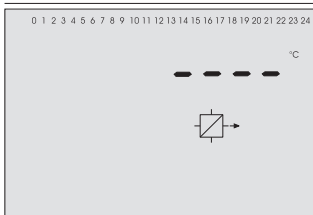

Parameter designation

Charging temperature (supply of heat exchanger)

- Press enter key to confirm.
The set point is displayed.

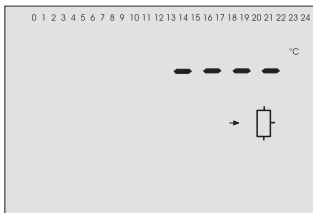

Charging temperature (supply of storage tank)

- Press enter key to confirm.
The set point is displayed.

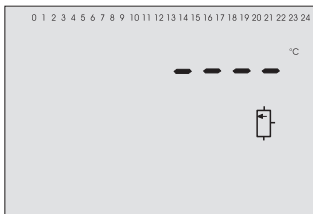

Storage tank temperature at sensor SF1

- Press enter key to confirm.
The set point is displayed.

Display

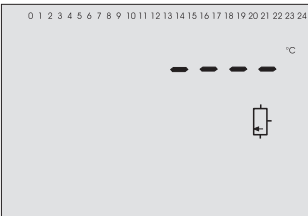

Parameter designation

Storage tank temperature at sensor SF2

- Press enter key to confirm.
The set point is displayed.

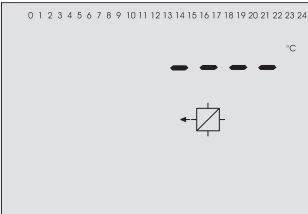

Storage tank temperature at return flow sensor

- Press enter key to confirm.
The set point is displayed.

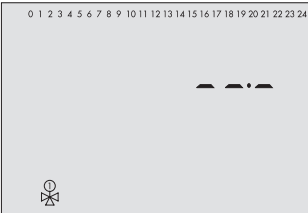

Control signal for continuous-action control

Only with Co4 -> Fb14 = ON

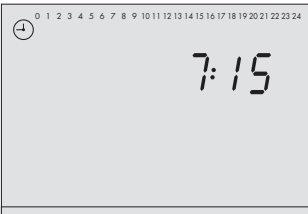

Time; Times-of-use for DHW demand

- Press enter key.
The times-of-use for Monday (1) are shown.
- Press the arrow key to view times-of-use of the other days of the week.



Times-of-use for circulation pump

- Press enter key.
The times-of-use for Monday (1) are shown.
- Press enter key.
Press the arrow key to view times-of-use of the other days of the week.

Inf5: District heating circuit

Display

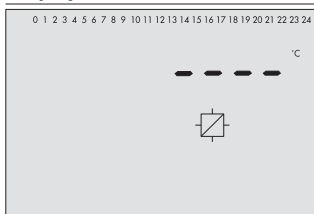

Parameter designation

Charging temperature



Press enter key to confirm.
The set point is displayed.

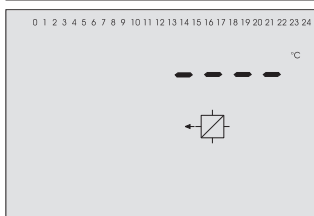

Return flow temperature at sensor RfF or RfFprim



Press enter key to confirm.
The set point is displayed.

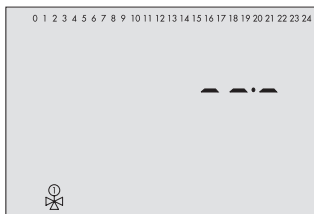

Valve position

Only with Co5 -> Fb16 = ON

Inf7: LON communication

Display

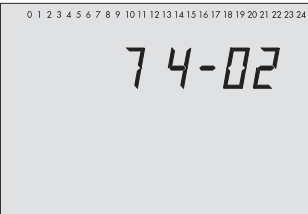

Parameter designation

Connected LON controller,
e.g. a TROVIS 5174 with LON address 2

- ⊗ Press enter key.
"FSr" of the corresponding controller is displayed.

Inf8: Error status register/sensor failure

Display

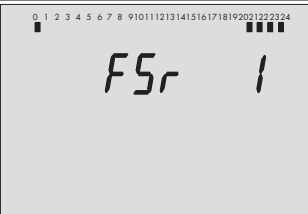

Parameter designation

Error status register FSr 1

- ⊗ Press enter key.
"FSr 2" appears

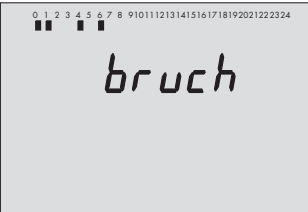

Sensor failure

The affected sensors are marked with a square below their assigned number:

0 (VF1) · 1 (RüF1) · 2 (AF1) · 3 (RF1) · 4 (VF2) · 5 (RüF2) · 6 (AF2)
7 (RF2) · 8 (VF3) · 9 (RüF3) · 10 (AF3) · 11 (RF3) · 12 (FG1)
13 (FG2_FGprim) · 14 (FG3) · 15 (VFprim) · 16 (RüFprim)
17 (VFT) · 18 (RüFTW) · 19 (SF1) · 20 (SF2)
21 (VFS) · 22 (flow rate)

InF9: Communication

(only with Co9 -> Fb01 = ON, Co9 -> Fb06 = ON or Co9 -> Fb10 = ON)

In the main display loop, the connection status appears in the InF9 level and only exists when the modem, SMS or fax function is active, otherwise just "END" appears on the display.

In this display, the applicable status from the following list of states appears when a modem connection is established.

- ▶ **PAUSE:** Device start (not yet initialized), dialing interval
- ▶ **INIT:** Modem has been initialized
- ▶ **FREE:** No connection established, modem is ready
- ▶ **RING:** Modem has been dialed, connection has not yet been established
- ▶ **CALL:** Modem is dialing the control station
- ▶ **CONN:** Connection to control station is established
- ▶ **ENDE:** Disconnection taking place

With "Fax function" setting, GENG3, 00, 40, 60, 80 appear on the display in sequence as the connection is being established.

12.4 Sensor resistance tables

Resistance values with PTC resistors

Type 5224 Outdoor Temperature Sensors, Type 5264 and Type 5265 Flow and Return Flow Temperature Sensors, Type 5264 Storage Tank Temperature Sensors

°C	-20	-10	0	10	20	25	30	40	50	60	70	80	90	100	110	120
Ω	694	757	825	896	971	1010	1050	1132	1219	1309	1402	1500	1601	1706	1815	1925

Type 5244 Sensor

°C	10	15	20	25	30
Ω	679	699	720	741	762

Switch position Ⓞ , terminals 1 and 2

Resistance values with Pt 1000 resistors

Type 5227-2 Outdoor Temperature Sensor, Type 5277-2 (thermowell required) and Type 5267-2 (contact sensor) Flow, Return Flow and Storage Tank Temperature Sensors. Type 5257-1, Type 5257-5 (room panel) Room Temperature Sensors.

°C	-35	-30	-25	-20	-15	-10	-5	0	5	10
Ω	862.5	882.2	901.9	921.6	941.2	960.9	980.4	1000.0	1019.5	1039.0

°C	15	20	25	30	35	40	45	50	55	60
Ω	1058.5	1077.9	1097.3	1116.7	1136.1	1155.4	1174.7	1194.0	1213.2	1232.4

°C	65	70	75	80	85	90	95	100	105	110
Ω	1251.6	1270.7	1289.8	1308.9	1328.0	1347.0	1366.0	1385.0	1403.9	1422.9

°C	115	120	125	130	135	140	145	150
Ω	1441.7	1460.6	1479.4	1498.2	1517.0	1535.8	1554.5	1573.1

Resistance values with Pt 100 resistors

Use the resistance values specified in the table for Pt 1000 resistors and divide the values by 10.

Type 5225 Outdoor Temperature Sensor, Types 5204, 5205-46 to -48 Flow and Return Flow Temperature Sensors, Types 5205-46 to -48 Storage Tank Temperature Sensors, Type 5255 Room Temperature Sensor.

12.5 Technical data

Inputs	
Sensor inputs	Max. 17 configurable inputs for temperature sensors Pt 100, Pt 1000, Ni 200, Ni 1000 und PTC, NTC, 0–10 V, 0/4–20 mA or binary alarms (heating/DHW circuit) 5 flow temperature sensors, 2 outdoor temperature sensors, 2 return flow temperature sensors, 2 room temperature sensors, 2 storage tank temperature sensors
Binary inputs	Storage tank thermostat
Other inputs	Pulse counter input for flow rate or capacity limitation Inputs for valve position feedback, remote operation to correct the room temperature and to select the operating mode
Outputs	
Analog output Control signal y	3 outputs 0 to 10 V (load > 4.7 k Ω) Three-step signal: 230 V~, 2 A On/off signal: 230 V~, 2 A
Binary outputs	5 outputs to control pumps, 230 V~, 3 A 4 outputs for alarms max. 50 V DC, 100 mA
Operating voltage	230 V, 48 to 62 Hz, 8 VA
Interface	RS-232 for connection to a modem, interface for meter bus LON (free topology)
Ambient temperature	0 to 40 °C
Storage temperature	-20 to 60 °C
Degree of protection	IP 40 according to IEC 529
Class of protection	II according to VDE 0106
Degree of contamination	2 according to VDE 0110
Overvoltage category	II according to VDE 0110
Humidity rating	F according to VDE 40040
Noise immunity	According to EN 61000-6-1
Noise emission	According to EN 61000-6-3
Weight	Approx. 0.6 kg

12.6 Customer data

Station	
Operator	
Relevant SAMSON office	
System code number	

Function block settings in configuration levels

	Co1	Co2	Co3	Co4	Co5	Co6	Co7	Co8	Co9
Fb00									
Fb01									
Fb02									
Fb03									
Fb04									
Fb05									
Fb06									
Fb07									
Fb08									
Fb09									
Fb10									
Fb11									
Fb12									
Fb13									
Fb14									
Fb15									
Fb16									
Fb17									
Fb18									
Fb19									
Fb20									
Fb21									
Fb22									
Fb23									

PA1 to PA3: Heating circuits HK1 to HK3

Parameters	PA1	PA2	PA3	Range of values
Gradient, flow				0.4 to 3.2
Level, flow				-30 to 30 °C
Maximum flow temperature				20 to 130 °C
Minimum flow temperature				20 to 130 °C
Set-back difference				0 to 50 °C
Gradient, return flow				0.4 to 3.2
Level, return flow				-30 to 30 °C
Outdoor temperature; point 1				-30 to 90 °C
Outdoor temperature; point 2				-30 to 90 °C
Outdoor temperature; point 3				-30 to 90 °C
Outdoor temperature; point 4				-30 to 90 °C
Flow temperature; point 1				20 to 130 °C
Flow temperature; point 2				20 to 130 °C
Flow temperature; point 3				20 to 130 °C
Flow temperature; point 4				20 to 130 °C
Return flow temperature; point 1				20 to 90 °C
Return flow temperature; point 2				20 to 90 °C
Return flow temperature; point 3				20 to 90 °C
Return flow temperature; point 4				20 to 90 °C
Set-back temperature; point 2				0 to 50 °C
Set-back temperature; point 3				0 to 50 °C
Day set point				10 to 90 °C
Night set point				10 to 90 °C
Sustained temperature				10 to 90 °C
Maximum return flow temperature				20 to 90 °C
Minimum return flow temperature				20 to 90 °C
OT activation value rated operation				-30 to 50 °C
OT deactivation value reduced operation				-10 to 50 °C
OT deactivation value rated operation				0 to 90 °C

Parameters	PA1	PA2	PA3	Range of values
Times-of-use				
Monday Start – Stop (1)				00:00 to 24:00 h
Monday Start – Stop (2)				00:00 to 24:00 h
Tuesday Start – Stop (1)				00:00 to 24:00 h
Tuesday Start – Stop (2)				00:00 to 24:00 h
Wednesday Start – Stop (1)				00:00 to 24:00 h
Wednesday Start – Stop (2)				00:00 to 24:00 h
Thursday Start – Stop (1)				00:00 to 24:00 h
Thursday Start – Stop (2)				00:00 to 24:00 h
Friday Start – Stop (1)				00:00 to 24:00 h
Friday Start – Stop (2)				00:00 to 24:00 h
Saturday Start – Stop (1)				00:00 to 24:00 h
Saturday Start – Stop (2)				00:00 to 24:00 h
Sunday Start – Stop (1)				00:00 to 24:00 h
Sunday Start – Stop (2)				00:00 to 24:00 h
Function block parameters Co1, Co2, Co3				
Limitation factor (Fb01 = ON)				0 to 25.5
Advance heating time (Fb05 = ON)				0 to 360 min
Start summer mode (Fb11 = ON)				01.01 to 31.12
Stop summer mode (Fb11 = ON)				01.01 to 31.12
Outdoor temp. limit in summer mode (Fb11 = ON)				0 to 30 °C
K_p (proportional gain) (Fb14/15 = ON)				0.1 to 50
T_N (reset time) (Fb14/15 = ON)				1 to 999 s
T_V (derivative-action time) (Fb14 = ON)				0 to 999 s
T_V (valve transit time) (Fb15 = ON)				15 to 240 s
UP lag time (Fb15 = ON/OFF)				120 to 1200 s
Hysteresis (Fb15 = OFF)				1 to 30 °C
Min. activation time (Fb15 = OFF)				0 to 600 s
Min. deactivation time (Fb15 = OFF)				0 to 600 s
Proportional gain (K_p) (Fb18 = ON)				0.1 to 999
Reset time (T_N) (Fb18 = ON)				1 to 999 s

Differential temperature control using variable weighting factors (Fb18 = ON)				0 to 40 °C
Function block parameters Co1, Co2, Co3				
Analog value max. (Fb18 = ON)				0 to 100 %
Analog value min. (Fb18 = ON)				0 to 100 %

PA1

Vacations (Start – Stop)									
Public holidays									

PA2

Vacations (Start – Stop)									
Public holidays									

PA3

Vacations (Start – Stop)									
Public holidays									

PA4: DHW heating

Parameters	PA4		Range of values
DHW demand ON			20 to 90 °C
DHW demand OFF			20 to 90 °C
Hysteresis			0 to 30 °C
Charging temperature			20 to 90 °C
Heat exchanger charging pump, deactivation value			20 to 90 °C
Storage tank charging pump, deactivation value			20 to 90 °C
Return flow limitation temperature			20 to 90 °C
Maximum charging temperature			20 to 120 °C
Times-of-use	DHW	ZP	
Monday Start – Stop (1)			00:00 to 24:00 h
Monday Start – Stop (2)			00:00 to 24:00 h
Tuesday Start – Stop (1)			00:00 to 24:00 h
Tuesday Start – Stop (2)			00:00 to 24:00 h
Wednesday Start – Stop (1)			00:00 to 24:00 h
Wednesday Start – Stop (2)			00:00 to 24:00 h
Thursday Start – Stop (1)			00:00 to 24:00 h
Thursday Start – Stop (2)			00:00 to 24:00 h
Friday Start – Stop (1)			00:00 to 24:00 h
Friday Start – Stop (2)			00:00 to 24:00 h
Saturday Start – Stop (1)			00:00 to 24:00 h
Saturday Start – Stop (2)			00:00 to 24:00 h
Sunday Start – Stop (1)			00:00 to 24:00 h
Sunday Start – Stop (2)			00:00 to 24:00 h

Function block parameters Co4		
Limitation factor (Fb02 = ON)		0 to 25.5
Activate priority in case of deviation (Fb06 = ON)		0 to 30 °C
Day of week (Fb08 = ON)		0, 1 to 7
Disinfection temperature (Fb08 = ON)		60 to 90 °C
Boost of charging temperature		0 to 30 °C
Start – Stop (Fb08 = ON)		00:00 to 23:30
T_V (valve transit time) (Fb09 = ON)		15 to 240 s
K_P (proportional gain) (Fb09/14 = ON)		0.1 to 50
T_N (reset time) (Fb09/14 = ON)		1 to 999 s
T_V (derivative-action time) (Fb14 = ON)		0 to 999 s
Data for heating circuits (Fb12 = ON)		1 to 3
Max. system deviation (Fb13 = ON)		2 to 10 °C

PA5: System-wide parameters

Parameters	PA5	Range of values
Gradient, return flow		0.4 to 3.2
Level, return flow		-30 to 30 °C
Maximum return flow temperature		20 to 90 °C
Minimum return flow temperature		20 to 90 °C
Maximum capacity of entire system		0.1 to 5999 kW
Maximum capacity of heating		0.1 to 5999 kW
Maximum capacity of DHW heating		0.1 to 5999 kW
Proport.-action coefficient for limitation		0.1 to 10
Maximum flow rate of entire system		0.01 to 99.9 m ³ /h
Maximum flow rate of heating		0.01 to 99.9 m ³ /h
Maximum flow rate of DHW heating		0.01 to 99.9 m ³ /h
Minimum flow rate		0.01 to 99.9 m ³ /h
Proport.-action coefficient for limitation		0.1 to 10
Outdoor temperature, point 1		-30 to 90 °C
Outdoor temperature, point 2		-30 to 90 °C

Parameters	PA5	Range of values
Outdoor temperature, point 3		-30 to 90 °C
Outdoor temperature, point 4		-30 to 90 °C
Return flow temperature, point 1		20 to 90 °C
Return flow temperature, point 2		20 to 90 °C
Return flow temperature, point 3		20 to 90 °C
Return flow temperature, point 4		20 to 90 °C
Max. limit of flow rate, point 1		0 to 99.9 m ³ /h
Max. limit of flow rate, point 2		0 to 99.9 m ³ /h
Max. limit of flow rate, point 3		0 to 99.9 m ³ /h
Max. limit of flow rate, point 4		0 to 99.9 m ³ /h
Max. limit of capacity, point 1		0 to 5999 kW
Max. limit of capacity, point 2		0 to 5999 kW
Max. limit of capacity, point 3		0 to 5999 kW
Max. limit of capacity, point 4		0 to 5999 kW
V-offset of the entire system		-300 to 300 m ³ /h
P-offset of the entire system		-3000 to 3000 kW
Function block parameters Co5		
Delay (Fb04 = ON)		1 to 6 °C
Max. system deviation (Fb07 = ON)		2 to 10 °C
Pulse weighting (Fb09 = ON)		0.1 to 10
Boost (Fb13 = ON)		0 to 30 °C
T _γ (valve transit time) (Fb14 = ON)		15 to 240 s
K _p (proportional gain) (Fb14/19 = ON)		0.1 to 50
T _N (reset time) (Fb14/19 = ON)		1 to 999 s
Hysteresis (Fb14 = OFF)		1 to 30 °C
Min. activation time (Fb14 = OFF)		0 to 600 s
Min. deactivation time (Fb14 = OFF)		0 to 600 s
T _v (derivative-action time) (Fb19 = ON)		0 to 999 s

Co9: Modbus and meter bus communication

Parameters				Range of values
Station number (ST.-NR)				1 to 247, 999
Baud rate (BAUD)				300 to 19200
Cyclic initialization (I)				1 to 255 min
Modem dial interval between calls (P)				0 to 255 min
Modem timeout (t)				0 to 255 min
Number of redial attempts (C)				1 to 99
Phone number of control station				max. 23 characters 0 to 9 P (pause) - (end)
Phone number of alternative recipient				
Access number				
Mobile phone number				
Fax number				
Station ID				
Function block parameters (Co9)	WMZ1	WMZ2	WMZ3	
Meter bus address (Fb21, 22, 23 = ON)				0 to 255
Model code (Fb21, 22, 23 = ON)				P15, PS2, 1434, CAL3, APAtO, SLS
Reading mode (Fb21, 22, 23 = ON)				24h, con, CoIL

Key number

1732

Index

4-point characteristic	40	Display	9
A		E	
Adaptation	48	Electrical connection	90 - 96
Advance heating		Enter key	6
outdoor temperature-dependent	45	Error archive register	70
Arrow keys	6	Error status register	72
Automatic mode	7 - 8	External demand	
B		processing	85
Baud rate	79	requesting	85
C		F	
Calibrating sensors.	24	Fault alarm	
Capacity limitation	64,82	as fax	74
Changeover key.	6	Fixed set point control.	42
Characteristics	39	Flash adaptation	48
Collective error alarm.	68	outdoor temperature dependent	48
Communication parameters	79	Flow rate limitation.	82
Condensate accumulation control	61	Forced charging, DHW storage tank	57
Configuration level.	97	Forced operation, pumps	59
Connection		Frost protection	59
Actuator.	91	Function block lists	97
Pump	91	Function block number	21
Sensor	91	Functions	21
Continuous-action control	63	G	
Control		Gradient characteristic	40
continuous-action	63	H	
on/off	63	Heating characteristic.	39
three-step	62	Holding register	70
Control station, phone number	80	I	
Controller time.	11	Information level	121
Customer data	130	Installation	
D		panel mounting	88
Day mode	8	top hat rail mounting	88
Default values	26	wall mounting	88
DHW heating			
in the storage tank charging system	54		
in the storage tank system	52		

Interface		Position feedback	51
Meter bus	81	Priority	
RS-232-C	77	DHW heating	56
RS-485	78	Pump management	50
K		R	
Key number	24	Rated operation	7 - 8
entering	24	Reduced operation	8
L		Release control loop	
Level structure	141	over the binary input	51
Limitation		Remote operation	46
using meter bus	82	Reset key	6
Locking		Resistance values	128
Manual level	66	Return flow temperature limitation	59
LON communication	84	Reverse control	56
M		Room panel	
Manual operation	8,27	Pt 1000	46
Modbus	13	PTC	46
Modem dialing pause	79	Room sensors	
Modem redialing attempts, number of	80	Pt 1000	46
Modem timeout	80	PTC	46
N		Room temperature-dependent control	49
Night mode	8	S	
O		Sending	
On/off control	63	controller time	86
Operating elements	6	Sensor calibration	24
Operating modes	8	Sensor failure	67
Operational faults	67 - 75	Set-back operation	57
Optimization	46	Start-up	20 - 26
Outdoor temp. adaptation, delayed	45	Station address	79
Outdoor temperature		Summer mode	44
forwarding	64	Summer time/winter time changeover	59
sending	86	System code number	20
Overvoltage protection	90	Description	28 - 38
P		T	
Parameter lists	107	Temperature monitoring	70
Parameters	23	Text message via SMS in case of fault alarm	74
		Thermal disinfection	57
		Three-step control	62

Time delays, compensating for	61	U	
Time-controlled operation	8	Universal inputs	24
Times-of-use		V	
copying	15	Vacation periods	18
setting	13	W	
		Weather-compensated control.	39

Frequently used abbreviations

AA	Analog output	RL	Return flow
AE	Analog input	RüF	Return flow sensor
AF	Outdoor sensor	RT	Room temperature
AT	Outdoor temperature	SF	Storage tank sensor
BA	Binary output	SLP	Storage tank charging pump
BE	Binary input	STh	Storage tank thermostat
Co	Configuration level	TLP	Heat exchanger charging pump
Fb	Function block	TW	Domestic hot water (DHW)
FG	Potentiometer	UP	Circulation pump
FW	District heating circuit	VF	Flow sensor
GND	Grounding	VFS	Flow sensor at storage tank
GWx	Limit issued to terminal x	VFT	Flow sensor at heat exchanger
GWy	Limit issued terminal y	VL	Flow
HK	Heating circuit	ZB	Meter bus
KW	Cold water	ZP	Circulation pump
RF	Room sensor		

InF1: Heating circuit 1
 InF2: Heating circuit 2
 InF3: Heating circuit 3
 InF4: DHW heating
 InF5: Primary control circuit
 InF7: LON communication
 InF8: Error status register
 InF9: Communication
 PU: Pump/manual level
 bln-E: Binary inputs and outputs
 Error: Error indication

PA1: Heating circuit 1
 PA2: Heating circuit 2
 PA3: Heating circuit 3
 PA4: DHW heating
 PA5: Capacity/flow rate limitation
 PA7: LON communication
 PA9: Communication

Anl: System

Co1: Heating circuit 1
 Co2: Heating circuit 2
 Co3: Heating circuit 3
 Co4: DHW heating
 Co5: Separate functions
 Co6: Sensor initialization
 Co7: LON communication
 Co8: Error initialization
 Co9: Communication

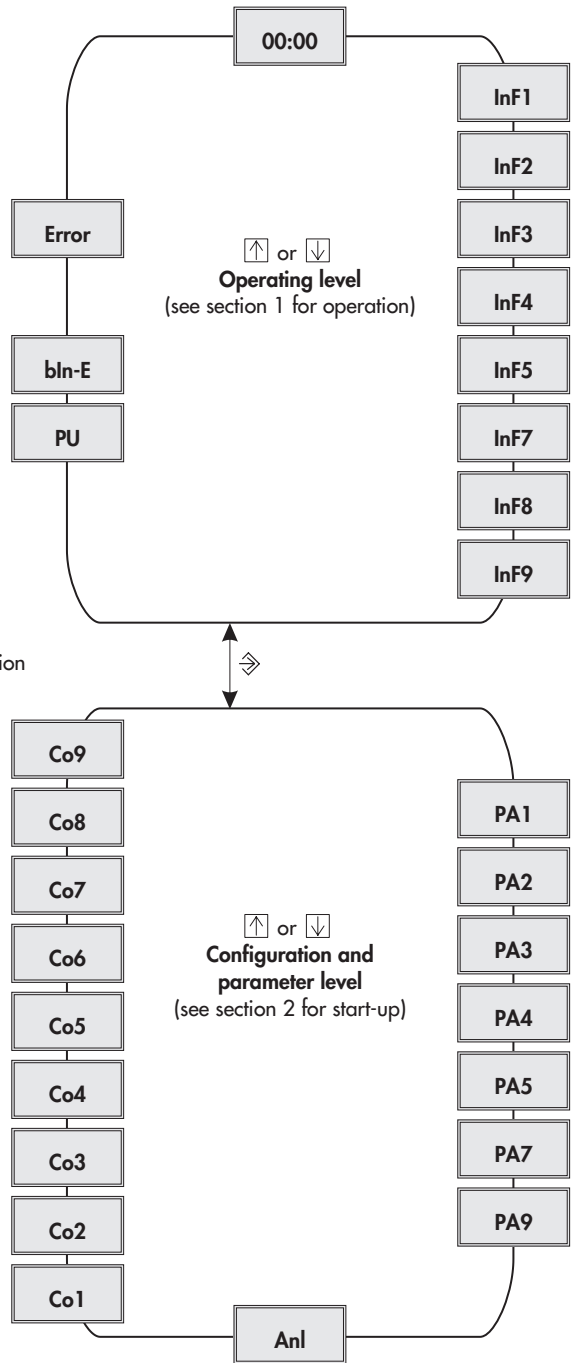

Fig. 10 · Level structure



SAMSON AG · MESS- UND REGELTECHNIK
Weismüllerstraße 3 · 60314 Frankfurt am Main · Germany
Phone: +49 69 4009-0 · Fax: +49 69 4009-1507
Internet: <http://www.samson.de>

EB 5179 EN

2006-03