

Automation System TROVIS 5100 Ventilation Controller TROVIS 5177



Mounting and Operating Instructions

EB 5177 EN

Firmware version 1.05
Edition September 2000

Contents

1	Scope of the ventilation controller	5
2	Safety instructions	6
3	Operation	7
3.1	Operating controls on front panel	7
3.1.1	Mode switch (A)	7
3.1.2	Selection switch for manual operation (B)	8
3.1.3	Changeover key and reset key (C, D)	8
3.1.4	Set point correction switch (F)	8
3.1.5	Arrow keys and enter key (H, I)	9
3.2	Manual operation mode	9
3.3	Control levels	12
3.3.1	Info levels	14
3.3.2	Changing system code number.	16
3.3.3	Control method	19
3.3.4	Parameter levels (PA1 to PA9)	19
3.3.5	Key code	30
3.3.6	Configuration levels (Co) and function blocks (Fb).	31
4	Description of systems	34
5	Function descriptions	48
5.1	Control method	48
5.1.1	Supply air temperature control	48
5.1.2	Exhaust air temperature control	48
5.1.3	Exhaust air temperature cascade control	49
5.1.4	Room temperature control	50
5.1.5	Room temperature cascade control	50
5.1.6	Supply air humidity control	51
5.1.7	Exhaust air/room humidity control	51
5.1.8	Exhaust air or room humidity cascade control	52
5.2	Inputs	53
5.2.1	Setting the type of sensor (Co6 Fb00...Fb13)	53
5.2.2	Calibrating the sensor (Co6 Fb23)	53
5.2.3	Analog inputs (Co5 Fb18...Fb21)	54
5.2.4	Binary inputs	54
5.2.5	Analog inputs	56
5.3	Outputs	57

5.3.1	Circulation pump control for the heating coil (BA3)	57
5.3.2	Enabling fan speed 1 (BA4)	57
5.3.3	Enabling fan speed 2 (Co4 Fb02, BA5)	57
5.3.4	Enabling the cold storage (Co3 Fb12, BA6)	58
5.3.5	Binary output dependent on Y3 (Co3 Fb12, BA6)	58
5.3.6	Controlling the chiller (Co3 Fb12, BA6)	59
5.3.7	Circulation pump control for the HRU (BA7)	59
5.3.8	On/off output of heating coil (Co1 Fb12, BA7)	59
5.3.9	Three-step output for heating coil (Co1 Fb13; BA6, BA7)	60
5.3.10	Fault alarm output (BA1)	60
5.3.11	Heating coil (Y1, Co1 Fb21)	60
5.3.12	Mixed air chamber (Y2, Co5 Fb07, Co2 Fb21, PA2)	60
5.3.13	Heat recovery unit (Y2, Co2 Fb21)	63
5.3.14	Humidifier (Y2,Y4, Co4Fb21)	64
5.3.15	Cooling coil (Y3)	65
5.3.16	Air volume control (Co4Fb04, Fb20; Co5Fb18...21, Y4)	65
5.3.17	Request for externally required signal over LON (Co1Fb01)	66
5.4	Time functions	68
5.4.1	Summer deactivation	68
5.4.2	Summer time operation (PA)	68
5.4.3	Automatic summer time/winter time changeover (Co5Fb16)	69
5.4.4	Public holidays and vacations (PA5)	69
5.4.5	Time schedules (times-of-use) (PA4, PA5)	69
5.5	Control functions	70
5.5.1	System start-up mode	70
5.5.2	Summer compensation (PA5)	71
5.5.3	Outdoor temperature-controlled supply air control	71
5.5.4	Sustained room temperature (Co5Fb05)	72
5.5.5	Night purge (Co5Fb17)	73
5.5.6	Air quality control via the mixed air chamber (Co5Fb18...21, PA)	73
5.5.7	Supply air temperature limit (Co5Fb01, Co5Fb18 PA5)	74
5.5.8	Return air temperature limit (Co5Fb04, PA1)	74
5.5.9	Variable return air temperature maximum limit (PA1)	75
5.5.10	Supply air humidity limit (Co5Fb06, Fb19; PA5)	75
5.6	Controller reaction when faults occur	76
5.6.1	Sensor failure and malfunctions	76

5.6.2	Setting default values	76
5.7	Protective functions	77
5.7.1	Frost protection	77
5.7.2	Locking settings (Co5Fb23)	78
5.7.3	Forced operation of the pumps.	78
6	LON communication (Co7, PA7, Co5 Fb03)	79
6.1	Configuring the LON interface	79
7	Serial interface (Co9)	81
7.1	Interface versions	81
7.2	Operation with a dial-up modem	82
7.2.1	Configuring the controller interface.	82
7.2.2	Parameters for operation with dial-up modem (PA9)	83
7.3	Status register	85
7.4	Operation with a dedicated line (bus operation)	86
7.4.1	Bus connection to RS-485 interface.	86
7.4.2	Configuring the interface	86
8	Memory module	87
8.1	Data transfer between controller and memory module	87
9	Installation	88
10	Electrical connection.	90
11	Technical data	93
Appendix A	Lists of function blocks	95
Appendix A.1	Configuration level Co1 for heating coil	95
Appendix A.2	Configuration level Co2 for heat recovery	95
Appendix A.3	Configuration level Co3 for cooling coil	95
Appendix A.4	Configuration level Co4	96
Appendix A.5	Configuration level Co5 of functions affecting all systems	97
Appendix A.6	Configuration level Co6 for sensor initialization	101
Appendix A.7	Configuration level Co7 for LON communication	102
Appendix A.8	Configuration level Co8 for error initialization.	102
Appendix A.9	Configuration level Co9 for Modbus communication.	103

Appendix B	Parameters	104
Appendix B.1	Parameters set in PA1 level	104
Appendix B.2	Parameters set in PA2 level	108
Appendix B.3	Parameters set in PA3 level	110
Appendix B.4	Parameters set in PA4 level	111
Appendix B.5	Parameters set in PA5 level	112
Appendix B.6	Parameters set in PA7 level (LON communication)	120
Appendix B.7	Parameter der Ebene PA9 (Modbus)	121
Appendix C	Operating level	124
Appendix C.1	Info level InF1	124
Appendix C.2	Info level InF2	125
Appendix C.3	Info level InF3	126
Appendix C.4	Info level InF4	127
Appendix C.5	Info level InF5	128
Appendix D	Resistance values of temperature sensors.	129
Appendix E	Customer data.	131
	Index	142
	Key code	145
	Important symbols on the display	149
	Front view.	150

1 Scope of the ventilation controller

The TROVIS 5177 Ventilation Controller is designed for controlling and monitoring air handling systems, ranging from simple air heaters right up to complex ventilation and air conditioning systems that contain heating coils, mixed air chambers, cooling coils, humidifiers and heat recovery units.

These mounting and operating instructions will enable you to operate the switches and keys of this controller as well as give an explanation of the electrical connection and mounting procedure. Also the extensive possibilities for configuration and parameterization are described. Please note that changes in configuration and parameterization require specialized knowledge on ventilation technology!

After the controller has been connected to the power supply, it is basically ready for operation. Since the controller functions according to time schedules, make sure the time and

date are set before start-up. Refer to page 22 onwards for step-by-step instructions on how to set the time and date.

The controller also saves information on configuration and parameters in a memory that can function for a long time without a power supply. Only the time and date need to be reset after a power failure.

The controller contains default setting to operate the ventilation system from 07.00 to 22.00 hours. If the two-speed fans are activated, the default setting for time-of-use between 10.00 and 15.00 hours. If you want a different time schedule for these setting, you must change the times-of-use. Refer to page 26 for details on how to change these settings.

If you require more information on a certain topic, use the subject index at the end of these instructions.

2 Safety instructions



- ▶ Assembly, start-up and operation of this device may only be performed by trained and experienced personnel familiar with this product. Proper transportation and storage are assumed.
- ▶ The controller is intended for use in electrical power installations. For wiring and maintenance, you are required to observe the relevant safety regulations.
- ▶ In automatic operating mode (time-controlled operation), the device ensures that all protective functions that are vital for the system are monitored. Safety features such as frost protection monitoring and excess temperature protection, however, are not active in the following cases: defective controller and failure of function; defective sensors or sensors that are not connected or have not been deactivated; lack of operating voltage to the controller.
- ▶ The installation and electrical wiring described in these instructions should only be performed by authorized personnel.
- ▶ Changing function blocks and their parameters (see Appendix A) requires specialized knowledge of ventilation systems and should only be performed by trained staff.

3 Operation

To understand the operation of this controller, use the fold-out page at the end of these mounting and operating instructions!

The controller is operated over switches and keys. They are accessible after the clear front door is opened. The mode switch (A) switches between the various operating modes. You can view parameters such as temperatures and set points using switch (C) and the keys (H) and (I) as well as determine the selectable functions and controller param-

eters. During which, you can access the various levels described in section 3.3. All settings made and the information required appear on the display (G).



It is also possible to transfer configuration and parameterization data with a memory module in the controller, refer to section 8. The following sections contain a description of the individual switches and keys as well as concerning the operation of the individual levels.



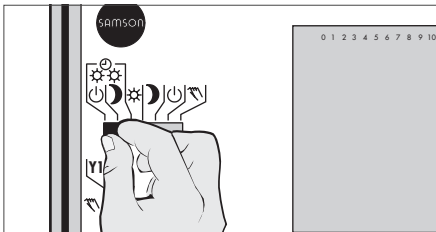

3.1 Operating controls on front panel

3.1.1 Mode switch (A)



Use this switch to select the operating mode:

-  **Automatic operation: Rated operation/stand-by operation:** The controller works according to set times-of-use and switches between rated and stand-by operation.
-  **Automatic operation: Rated operation/reduced operation:** The controller works according to set times-of-use and switches between rated and, in

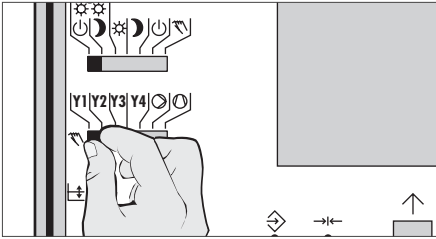

-  contrast to previous mode, reduced operation.
-  **Rated operation:** The ventilation system is constantly in operation. It is controlled acc. to the set point(s) for day, e.g. Supply air day set point.
-  **Reduced operation:** The ventilation system is constantly in operation. It is controlled acc. to the set point(s) for night, e.g. Supply air night set point.
-  **Stand-by operation:** The ventilation system is switched off. The frost protection is active, provided it has been enabled, see section 5.7.1
-  **Manual operation:** In combination with the selection switch for manual operation (B), the ventilation controller can be operated in the manual mode, see section 3.2.

3.1.2 Selection switch for manual operation (B)



If the mode switch (A) is set to manual mode and the manual level is activated, you can use this switch to operate the output which



you have selected over the selection switch for manual operation (B), see section 3.2.

- Y1 Control output Y1 (heating coil)
- Y2 Control output Y2 (humidifier, mixed air chamber, heat recovery unit)
- Y3 Control output Y3 (cooling coil)
- Y4 Control output Y4 (humidifier Anl 8 and Anl 9)
-  Pump(s)
-  Fans (former symbol )

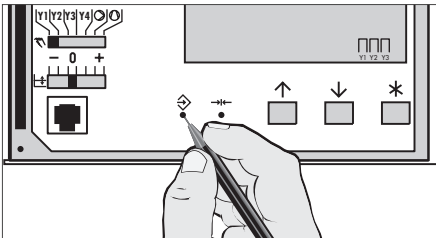
3.1.3 Changeover key and reset key (C, D)



These keys must be operated with a pointed object (e.g. pencil). The following functions are available:

-  **Changeover key** lets you change between the main levels: operating and configuration levels.
-  **Reset key** resets all parameters in the parameter level (!) to their default settings.

3.1.4 Set point correction switch (F)

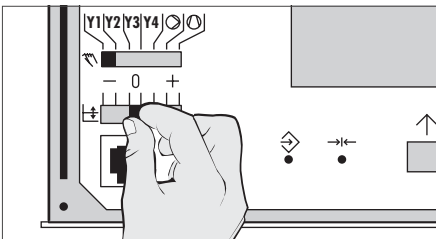

The set point can be increased or reduced with the aid of this switch.

- Set point is reduced by 1 K per raster
- 0 No change in set point
- + Set point is increased by 1 K per raster

3.1.5 Arrow keys and enter key (H, I)

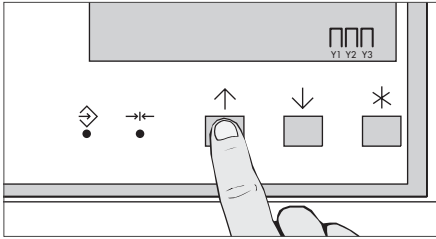

- ↑ ↓ **Arrow keys** let you scroll within levels, select parameters and function blocks as well as increase and reduce values
- * **Enter key** lets you activate levels, parameters, function blocks as well as confirm changed values

3.2 Manual mode



Note!

In manual mode, the user can set the outputs anyway as required. On selecting the manual mode, all limit temperatures and logical links ceased to be in force. The user has absolute control and takes on responsibility for interaction between all the outputs and the resulting consequences.

As soon as you set the mode switch to the  switch position, all operating states of the controller outputs are “frozen”, i.e. the control signals as well as the switching states of the binary outputs from automatic operation are kept regardless of the input variables. If

you have changed the output variables over manual mode, these states are maintained until you exit the manual mode. The system frost protection is guaranteed provided that the function block Co5 Fb15= ON is activated.

Activating manual mode

Press

Display shows

Comments

Slide the mode switch (A) to

The display remains unchanged.

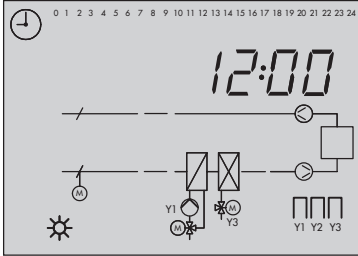

↑

Press enter key until "Hand" appears on the display.

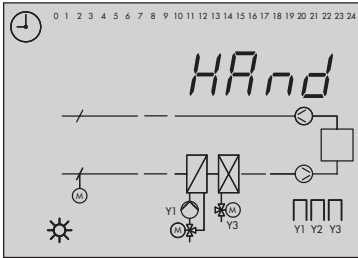

*

Press the enter key. The state of the selected output and the associated symbol blinking in the schematics appear on the display. This example shows Y1 (heating coil) as the selection switch (B) is positioned at Y1.

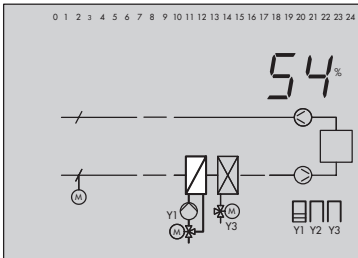

Slide the selection switch for manual operation (B) to the output that you want to change!

- Y1 Control signal Y1
- Y2 Control signal Y2
- Y3 Control signal Y3
- Y4 Control signal Y4
- Pump(s)
- Fans

The associated symbol blinks on the display. **Note:** - - - appears when this output is not connected.

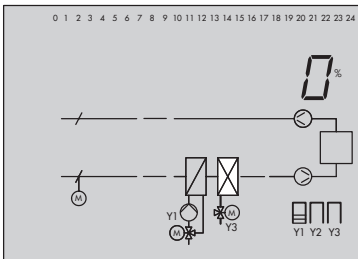

Press

Display shows

Comments

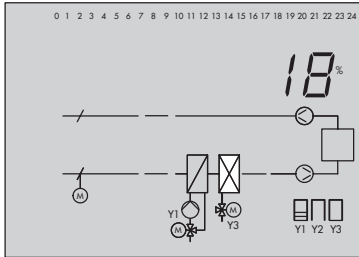

Activate the output, observing:
Switch on pumps, fan; increase control signal
Switch off pumps, fan; reduce control signal

Note: For two-speed fans, you can select On1, On2 or OFF.

Optionally

*

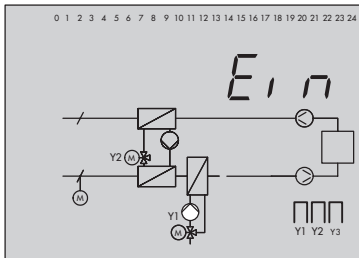

When the selection switch (B) is set to the pump symbol and several pumps are controlled, e.g. with An1 3, use the enter key to select another pump! The symbol of the selected pump blinks on the display, when the pump is switched off, just the circuit blinks.

Any changes to an output are kept if you push the selection switch for manual operation (B)!

Exiting manual mode

Slide

Display shows

Comments

the mode switch (A) to

☞

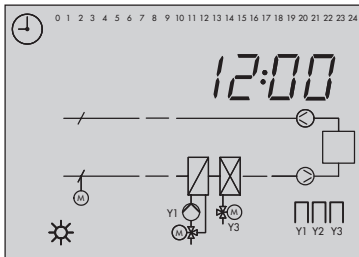

3.3 Control levels



Note!

Any changes in the configuration level (PA and CO levels) may cause errors in the system. Therefore, they must be only performed by the specialist!

Fig. 1 shows the level structure in the TROVIS 5177 Ventilation Controller. It also shows the operating steps that need to be taken to access each individual level. The controller contains two main levels: the operating level and the configuration level. Use the changeover key (C) to switch between the levels. The operating level contains the info levels, in addition to this, when switched to the manual mode, a manual level is also accessible. The configuration level contains the parameter levels, the system code number level and the configuration levels. The info, parameter and configuration levels are assigned to an index from 1 to 9 which is the same in all three levels. In this way, specifications concerning the heating coil are always termed InF1, PA1 und Co1 (index 1) according to the level. All other indices are summarized in the table opposite.

Usually, the ventilation controller is in the operating level and the time appears on the display. In Fig. 1, for example, "10:24" is indicated on the display. Apart from the time, symbols to represent the operating mode and operating status as well as the system represented symbolically appear on the display. Refer to page 147 for a summary of the major symbols.

A bar graph appears on bottom right-hand

corner of the display, showing roughly the control signals Y1, Y2 and Y3. This bar graph is shown in the operating level.

Note: Two minutes after the last entry, the controller returns automatically from the configuration level back to the operating level.

Designation of levels	Information, parameters, functions
InF1, PA1, Co1	Heating coil
InF2, PA2, Co2	Heat recovery unit, mixed air chamber
InF3, PA3, Co3	Cooling coil
InF4, PA4, Co4	Fans, humidifier
InF5, PA5, Co5	Functions affecting all systems
Co6	Sensor initialization
PA7, Co7	LON communication
Co8	Error initialization
PA9, Co9	Modbus communication
An1	System code number and control method

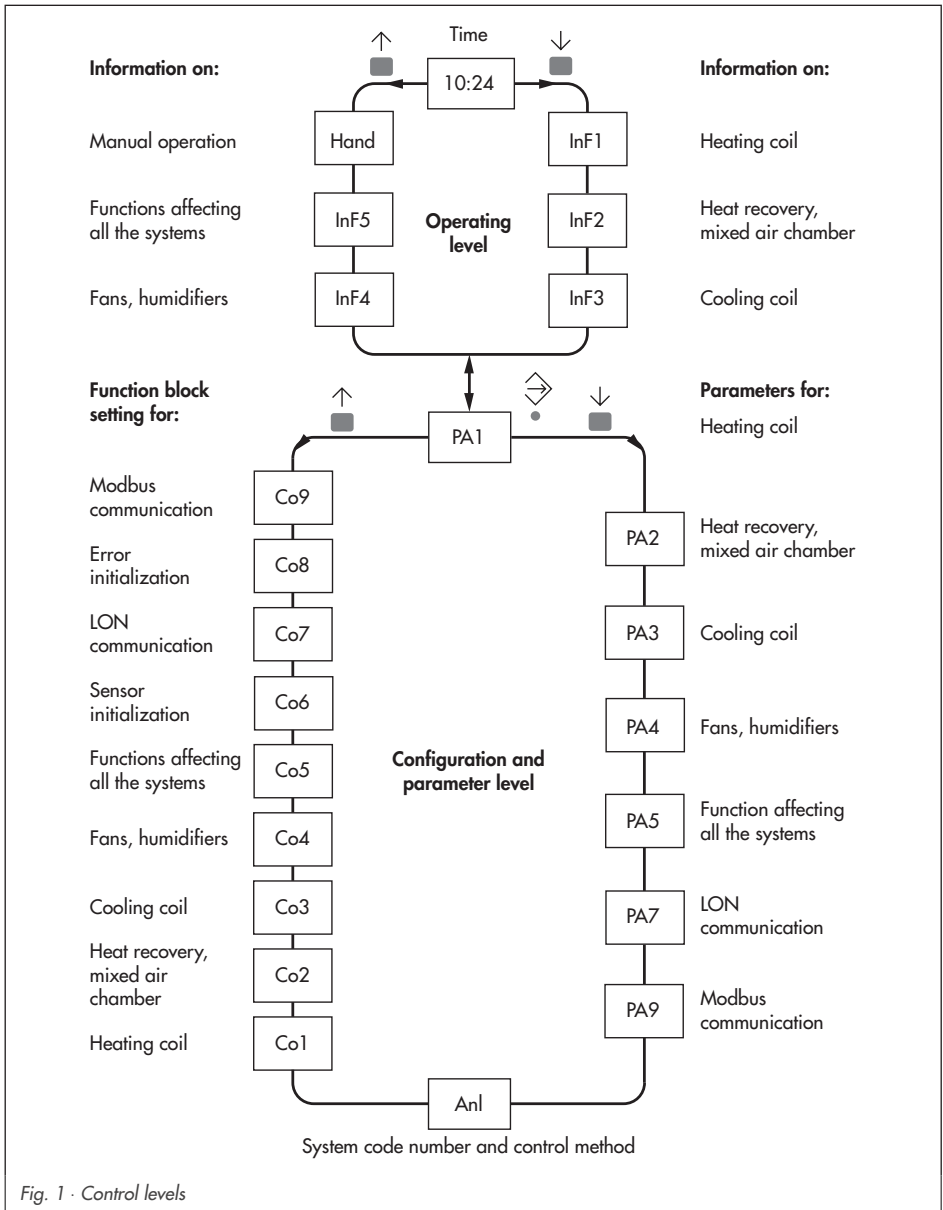

Fig. 1 - Control levels

3.3.1 Info levels

Information is displayed in the info levels (InF1 to InF5) about, for example, the operating states of the pumps and fans, or control signals and values of the temperature sensors. The system code number and configuration determine what sort of information is

shown on the display. Refer to Appendix C for a summary of symbols that appear on the display and their meanings. It is not possible to make any changes to parameters when the controller is in an info level.

Activating the info level (from the operating level)

Press

↑ or ↓

Display shows

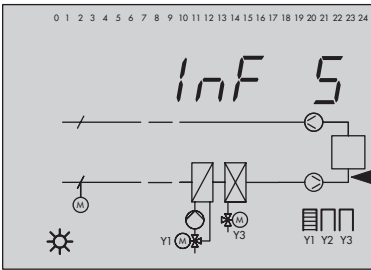

Comments

Use arrow keys to find the required InF level (InF1 to InF5)

*

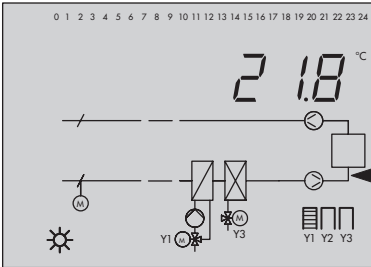

Press enter key to activate the info level. The first piece of information appears on the display. This example shows the supply air temperature.

Press

↑ or ↓

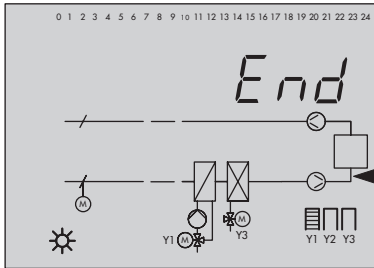
Display shows**Comments**

Every time you press the key, another piece of information appears on the display. See page 123 ff for further displays. On reaching the end of an info level, **End** appears on the display.

Exiting an info level**Press**
 ↑↓
 both
Display shows

Any display

Comments

Press both arrow keys simultaneously. The next info level appears on the display (depending on the system code number)

or

*

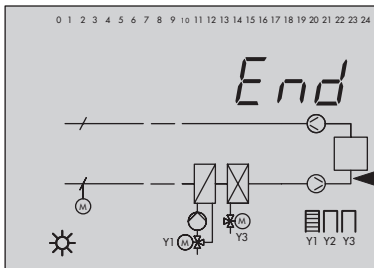

When **End** appears on the display, press the enter key. In this way, you can also access the next info level.

3.3.2 Changing the system code number

The ventilation controller contains different types of systems which are assigned to system code numbers 0 to 9. They are determined in the configuration level under *Anl* (system code number). By entering the system code number, you determine both the inputs and outputs of the controller as well as the selectable function blocks and parameters. You can find a list of the different systems in section 4.

Every change in system code number or control method (supply air control, exhaust air control) causes the assignment of sensors to be reprogrammed: the sensor inputs required for the function blocks are activated and the sensor inputs not used are deactivated. These settings can be changed manually. Proceed as follows to change the system code number:

Press



Display shows

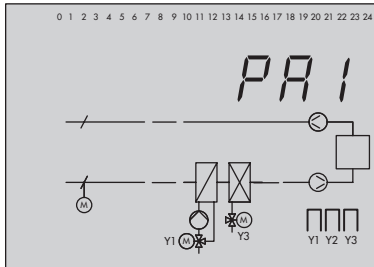

Comments

Press changeover key! The parameter level *PA1* appears on the display.

↑ or ↓
until

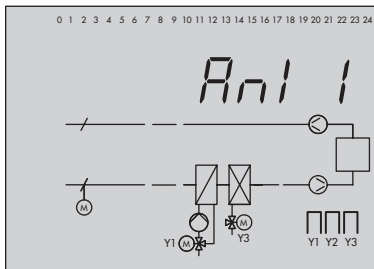

Press arrow keys until **An1** appears on the display. In addition to **An1**, the current system code number appears. This example shows 1.

Press



Display shows

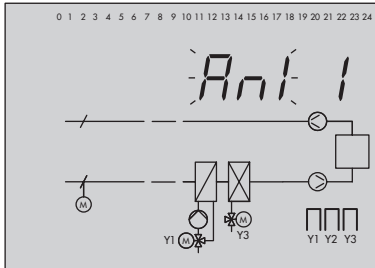

Comments

Press enter key to activate the system code number to change it. **Anl** starts to blink on the display.

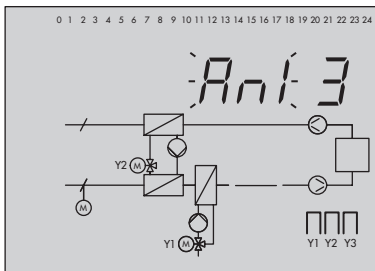

Select the system code number you require using the arrow keys. Every time you press the key, the schematics depicting the system change on the display.

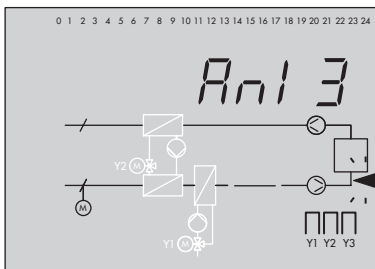

Confirm the new system code number with the enter key. **Anl** no longer blinks on the display. However, the system elements start to blink as well as one or two arrows to indicate the control method. This example shows supply air control.

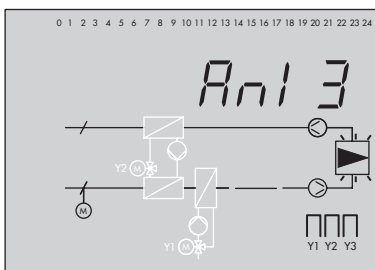

Use the arrow keys to select a different control method. Each control method is shown by the arrows on the right-hand side: in supply air duct, exhaust air duct, or both, in the room, or in the room and supply air duct; this example shows room control.

Press



Display shows

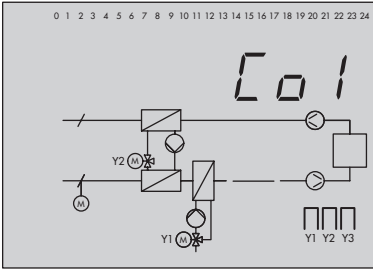

Comments

Press enter key to confirm the control method. **Co1** appears on the display. If this is not the case, you have selected Anl 6, 8 or 9, see the next step on how to proceed.

For Anl. 6, 8, 9 the control method for the humidifier control circuit now appears on the display. The cooling coil and humidifier blink. Set the control method in the same way as described for the temperature control circuit. When selecting using the arrow keys, a difference is made between humidifying and dehumidifying operation mode or just humidifying operation mode. When the latter applies, just the humidifier blinks on the display.

Press



Display shows

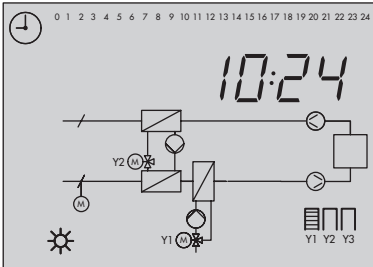

Comments

Press the changeover key to change to operating level.

3.3.3 Control method

You can choose between the following control methods for all systems:

- ▶ Supply air temperature control,
- ▶ Exhaust air temperature control,
- ▶ Exhaust air temperature cascade control,
- ▶ Room temperature control or
- ▶ Room temperature cascade control.

For systems Anl 6, 8 and 9 (air-conditioning systems) the control method needs to be set for the temperature control circuit as well as for the humidity control circuit. For the humidity circuit, you can choose between:

- ▶ Supply air humidity control,
- ▶ Exhaust air humidity control,
- ▶ Exhaust air humidity cascade control,
- ▶ Room humidity control or

- ▶ Room humidity cascade control.

The difference between temperature and humidity control circuits is shown on the display by blinking symbols. For the temperature control circuit, heating and cooling coil blink on the display. For the humidity control circuit, the cooling coil and humidifier blink on the display. Additionally, for the humidity control circuit, a difference is made between humidifying and dehumidifying operation and just humidifier operation.

You can set the control method in the configuration level under the system code number Anl. Refer to "Changing the system code number" in section 3.3.2 on page 16.

3.3.4 Parameter levels (PA1 to PA9)

In the parameter levels PA1 to PA9, you can change parameters which have been enabled by the configuration. The parameters

are recognizable by a combination of symbols that appear on the display. You will find a summary in Appendix B.

If you want to change parameters, proceed as follows:

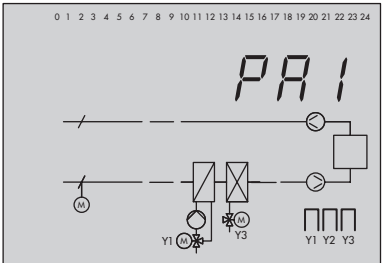
Press	Display shows	Comments
	<p>Refer to Appendix B for the parameter levels and the symbols assigned to the parameter(s).</p> 	<p>Press the changeover key to change to parameter level PA1.</p>

Press

↑ or ↓
until

Display shows

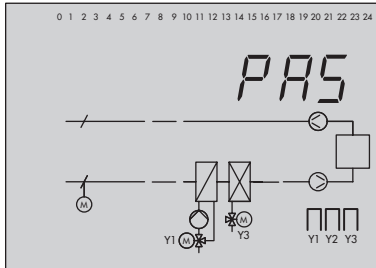

Comments

Use the arrow keys to select the parameter level needed. This example requires PA5.

*

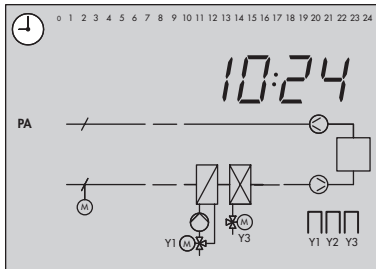

Press the enter key to access the parameter level PA5. The first parameter appears. In the example, it is the time.

↑ or ↓
until

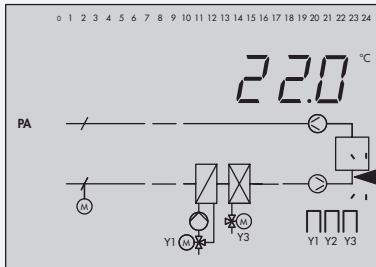

Use the arrow key until the parameter that you want to change appears on the display. In the example, it is the supply air temperature day set point.

*

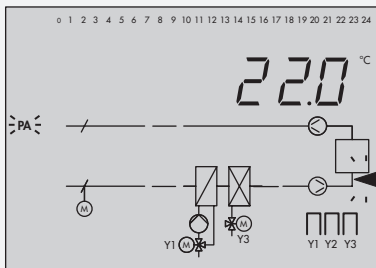

Press the enter key to activate the parameter. **PA** starts to blink on the display.

Press

Display shows

Comments

↑ or ↓

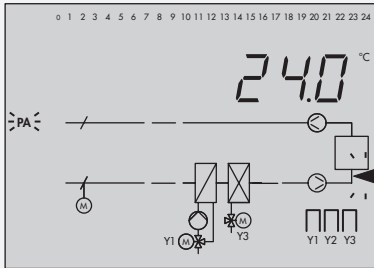

Use the arrow keys to set the new value for the parameter.

Note: The longer you press an arrow key, the quicker the value changes.

*

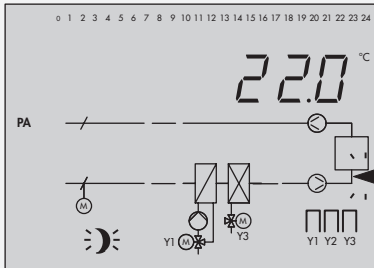

Press the enter key to confirm the new value. The next parameter appears on the display. In the example, it is supply air temperature night set point. It may be another parameter as it depends on the configuration!

↑↓
both

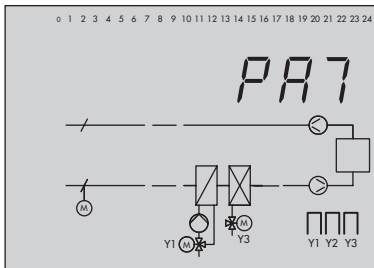

Repeat the instructions in the gray box to change other parameters, if need be.

Press both arrow keys simultaneously. The next PA level appears. **Note.** If *End* appears on the display, you can also press the enter key. If PA is not shown, this means a parameter is activated. Press the enter key first.

Press



Display shows

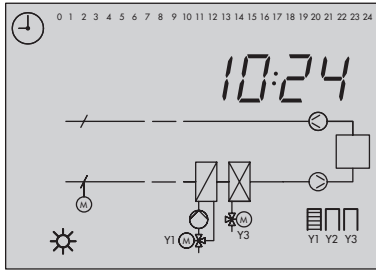

Comments

Press the changeover key to exit the configuration level.

Setting the time and date

Press



Display shows

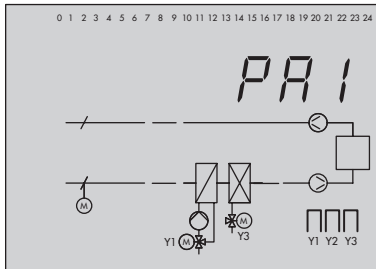

Comments

Press the changeover key! The parameter level PA1 appears on the display.

↓ until

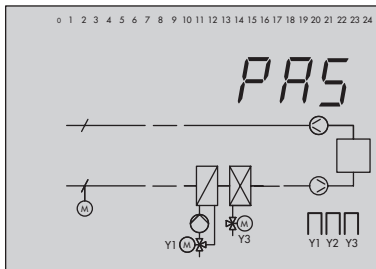

Press the arrow key until **PA5** appears on the display.

Press

Display shows

Comments

*

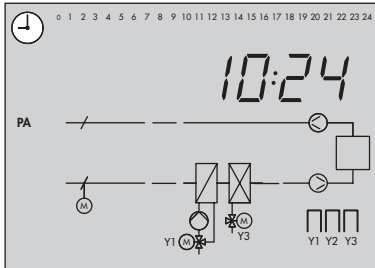

Press the enter key. The first parameter of parameter level PA5 is shown: the time, 10:24 h in this example.

*

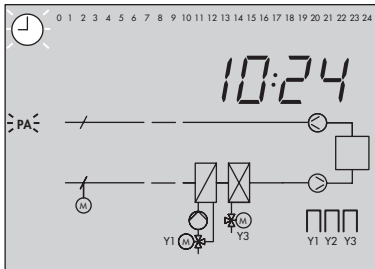

Press the enter key to activate the time to change it. The time and **PA** start to blink on the display.

↑ or ↓

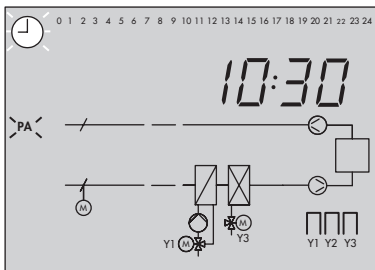

Use the arrow keys to set the new time.

*

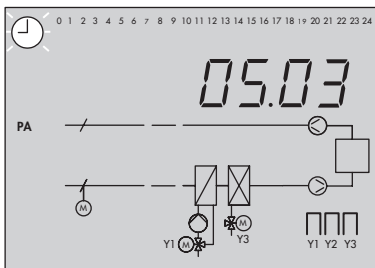

Press the enter key to confirm the new time. The date now appears on the display.

Press

Display shows

Comments

*

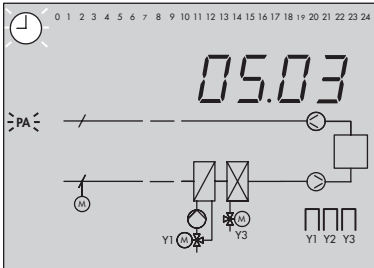

Press the enter key to activate the date to change it. The date and **PA** start to blink on the display.

↑ or ↓

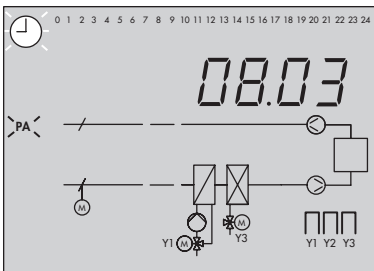

Use the arrow keys to set the new date.

*

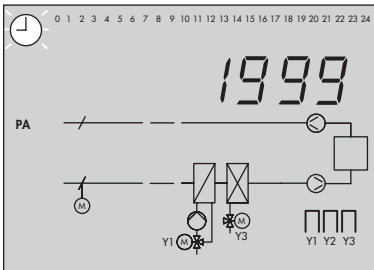

Press the enter key to confirm the new date.
The year now appears on the display; 1999 in this example.

*

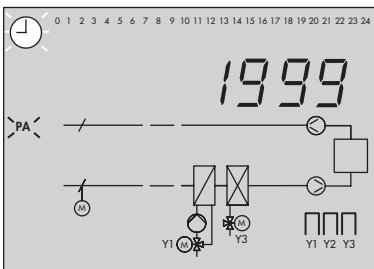

Press the enter key to activate the year to change it. The year and **PA** start to blink on the display.

Press

↑ or ↓

Display shows

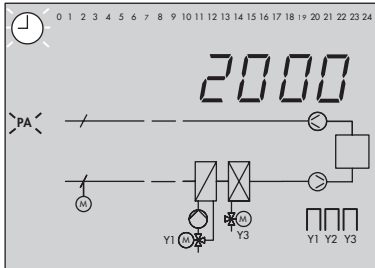

Comments

Use the arrow keys to set the new year.

*

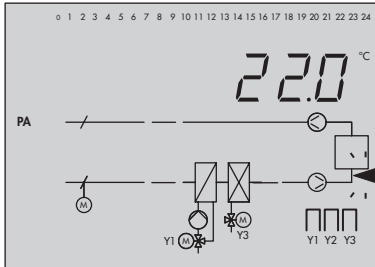

Press the enter key to confirm the new year.
A new parameter appears on the display. In this example, it is the supply air temperature day set point.

⇒

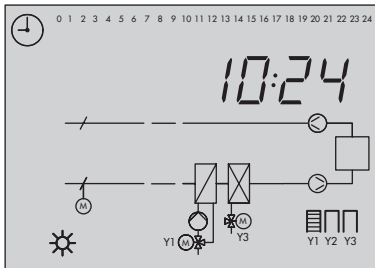

Press the changeover key to change to the operating level. The time is shown on the display.

Note: If this is not the case, a parameter is still activated. You must press the enter key first.

Programming the time schedules (times-of-use)

You can enter the time schedules separately for the system (PA5) and, if required, for the fan speed 2 (PA4). Refer to pages 118 and 111 for the relevant symbols. You can also set the time schedule as described as follows. You can enter two time periods for each day.

Example: The time schedules for every week day are to be changed. The time-of-use was previously set between 07.00 h and 22.00 h (default setting). The new times-of-use are to be between 06.00h and 14.00 h as well as between 19.00 h and 23.00 h. The following settings must be entered at the controller:

Press



Display shows

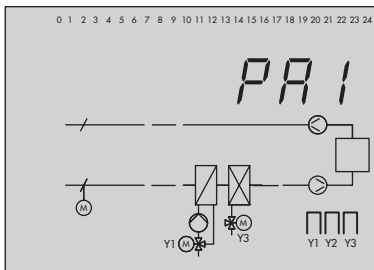

Comments

Press the changeover key to access the parameter level PA1.

↓ until

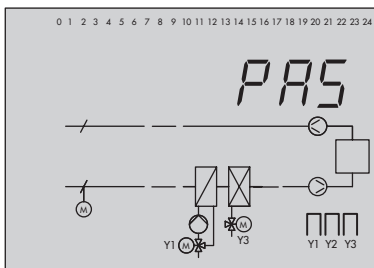

Press the arrow key until **PA5** appears on the display.

*

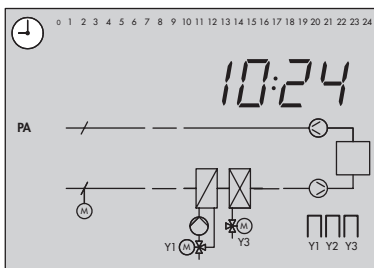

Press the enter key. The time appears on the display.

Press

↓
until

Display shows

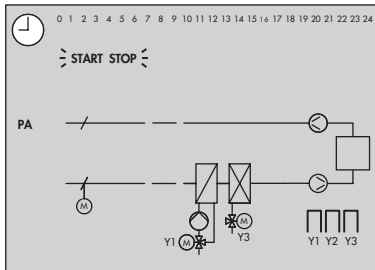

Comments

Press the arrow key until the symbol for the system times-of-use appears on the display.

*

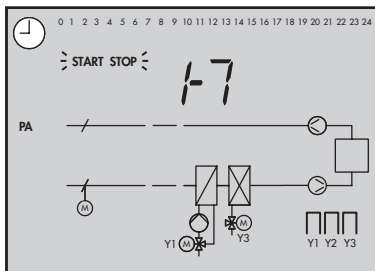

Press the enter key. **1-7** appears on the display.

↑ or ↓

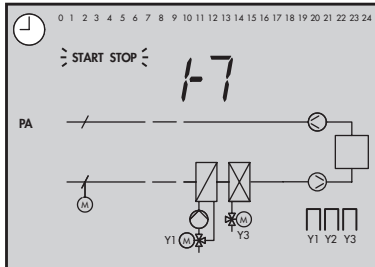

Use the arrow keys to select for which day(s) you want to change the times-of-use: 1-7 (all days), 1-5 (Monday to Friday), 6-7 (Saturday and Sunday) or 1, 2, ..., 7 (Monday, Tuesday, ..., Sunday). In this example, 1-7 is to be set.

Note: When 1-7, 1-5 or 6-7 are selected, the times-of-use for the days selected are reset to the default settings. Therefore do not use this menu to check the programmed time schedules! Use just the menu for the individual days 1, 2, ..., 7 instead!

Press

*

Display shows

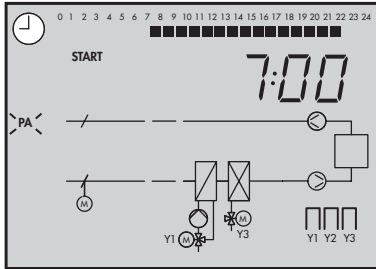

Comments

Press the enter key. The starting time for the first time-of-use appears; in this example, 07.00 h. The clock and PA start to blink on the display.

↑ or ↓

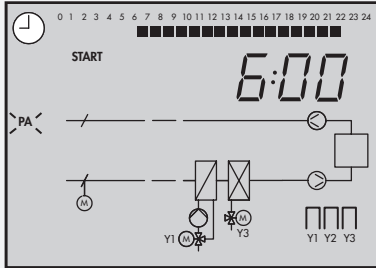

Use the arrow keys to set when the first time-of-use period should start (6:00 h in the example).

Note: You can only enter this time in 30-minute steps. The time set is shown at the top of the display as black squares (one square equals one hour).

*

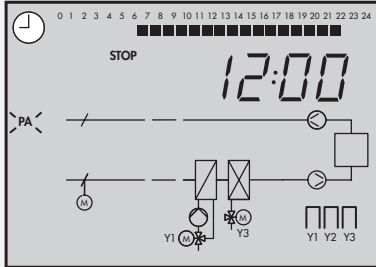

Press the enter key to confirm the new starting time. Now, the time when the first time-of-use finishes appears on the display (12:00 h in the example).

↑ or ↓

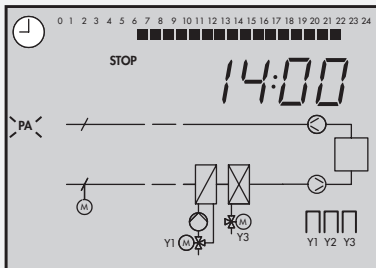

Use the arrow keys to set when the first time-of-use period should finish (14:00 the example).

Press

Display shows

Comments

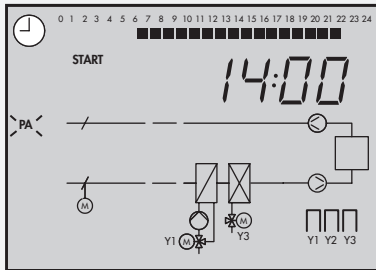

Press the enter key to confirm the new finishing time. Now, the time when the second time-of-use starts appears on the display (14:00 h in the example which the same time when the first time-of-use period finishes).

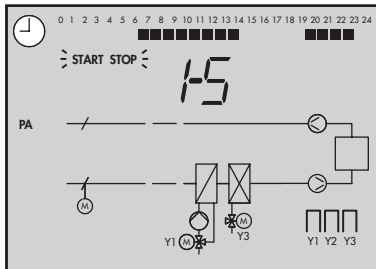

Repeat the procedure to set the second time-of-use to start at 19.00 h and finish at 23.00 h. Follow the instructions in the gray box. Then **1-5** appears on the display.

Note: If you need just one continuous time-of-use period, set the same time for the start of the second time period and the end of the first time period.

until

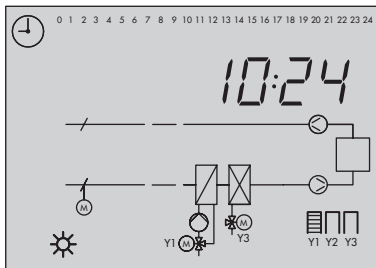

Press the arrow key until the same display as shown here appears (vacations). You have now exited the menu for times-of-use (time schedules).

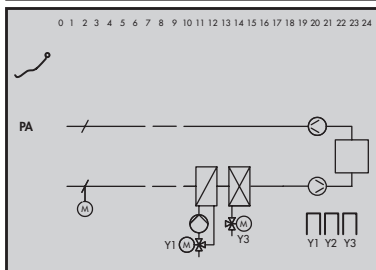

Press the changeover key to exit the configuration level and return to the operating level.

3.3.5 Key code



Caution!

The key code may only be used by trained personnel!

Several functions are protected against unintentional and unauthorized access. These functions can only be altered when the key code is known. The key code is written on

page 143. Tear out this page or blank out the key code to prevent its unauthorized use. If you are prompted to enter the key code, proceed as follows:

Press

Display shows

Comments

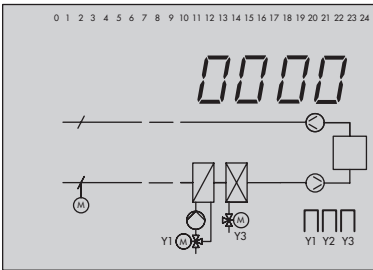

If the same display as shown here appears, you are being prompted to enter the key code.

↑ or ↓

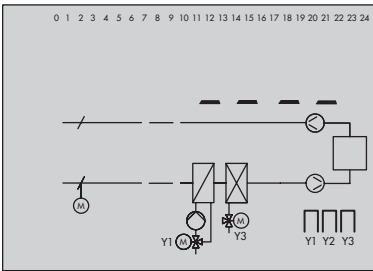

Use the arrow keys to enter the key code (see page 143)

Note: The longer you press an arrow key, the quicker the numbers change on the display.

*

Press the enter key to confirm the key code. When the correct key code has been entered, the function block you want to change starts then to blink on the display.

Note: The key code remains active three minutes after the last key has been pressed!

3.3.6 Configuration levels (Co) and function blocks (Fb)

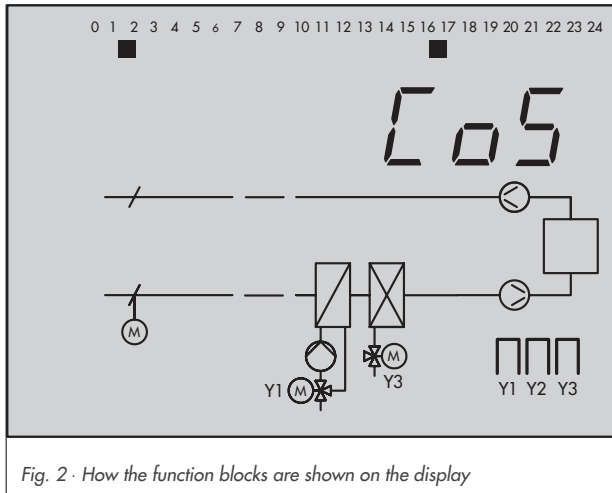

Fig. 2 · How the function blocks are shown on the display

The ventilation controller has various configuration levels (Co levels), in which functions are grouped according to their area of activity. Each configuration level consists of function blocks. The configuration levels are designated Co1 to Co9 and the function blocks Fb00 to Fb23. You can activate or deactivate

the function blocks to determine the selectable functions available in the controller. You will need to enter the key code before changing some of the function blocks. For various function blocks, you must also set the function block's parameters. Refer to Appendix A for a list of function block parameters. At first, the functions are determined by the system code number and the control method. It also determines the parameters in the parameter levels (PA1 to PA9).

On activating the Co level, the activated function blocks are indicated at the top of the display by the squares located to the bottom right of each function block number, see Fig. 2.

If you want to change the function blocks, proceed as follows:

1. Find out which function block you need in the Appendix A, noting the index of the Co level.
2. Access the configuration level and then the required Co level as described in the section below "Accessing a Co level".
3. Change the function block as described in the section on "Changing function blocks".
4. Exit the configuration level as described in section on "Exiting the configuration level".

Accessing a Co level (from the operating level)



Press the changeover key with a pointed object to access the config-

uration level. **PA1** appears on the display.

- ↑
or
↓
- Press an arrow key until the required Co level Co1 to Co9 appears on the display

Note: You can see at the top of the display which function blocks (Fb) are activated (squares located under the right-hand side of the

- number).
* Press the enter key to access the Co level you want to change. The first function block **Fb00** appears on the display.

Changing function blocks

- ↓ Access the Co level as described.
↓ Use the arrow key to find the function block you want to change.
* Press the enter key to access the function block. **Fbxx** now appears on the display, and can be changed.

Note: If **0000** is shown on the display, this is a prompt for entering the key code, see page 30.

- ↑ Press the upward arrow key to **activate** the function block.
↓ Press the downward arrow key to **deactivate** the function block.
* Press the enter key to confirm the setting. Depending on the function block setting, a square appears underneath the function block number at the top of the display (Fb is activated) or a square disap-

pears underneath the function block number at the top of the display (Fb is deactivated). Besides this, either the next function block or a function block parameter appears on the display.

Function block parameters are immediately active. Proceeds as follows:

- ↑ or ↓ Use the arrow keys to set a new value.
* Press the enter key to confirm the new value. Following this, either the next function block parameter, the next function block or **End** appears on the display. If necessary, change further function blocks and their parameters. Alternatively, exit the Co level or configuration level as described below.

Exiting a Co level

- ↑↓ both Press both arrow keys simultaneously. The next Co level or PA level appears on the display.

Note: Display should not start blinking. A blinking display requires first the enter key to be pressed to confirm the setting.

- * or
* If you have reached **End** on the display, press the enter key. The next Co level or the next function block appears on the display.

Exiting the configuration level



Press the changeover key to return to the operating level.

Note: The controller automatically returns to the operating level two minutes after the last key has been pressed!

4 Description of systems

The ventilation controller can be used to control ten different types of systems which are assigned system code numbers in the controller. The system code number (*An1*) is fixed in the configuration level Co. Default setting is An1 1. If you want to change the system code

number, refer to section 3.3.2 for more details. The table below contains the main differences between the system types. Each system type is described on the following pages.

System code number	Description of the system
System 0	Ventilation system with a heating coil
System An1 1	Ventilation system with a heating coil and a cooling coil (also chilled ceiling or direct expansion coil 1-speed)
System An1 2	Ventilation system with a heating coil and a mixed air chamber
System An1 3	Ventilation system with a heating coil and a heat recovery unit
System An1 4	Ventilation system with a heating coil and cooling coil (also chilled ceiling or direct expansion coil 1-speed) and a mixed air chamber
System An1 5	Ventilation system with a heating coil and a cooling coil (also chilled ceiling or direct expansion coil 1-speed) and a heat recovery unit
System An1 6	Air-conditioning system with a heating coil and a cooling coil and a humidifier
System An1 7	Ventilation system with a cooling coil (also chilled ceiling or direct expansion coil 1-speed)
System An1 8	Air-conditioning system with a heating coil and a cooling coil, a mixed air chamber and a humidifier
System An1 9	Air-conditioning system with a heating coil and a cooling coil, a heat recovery unit and a humidifier

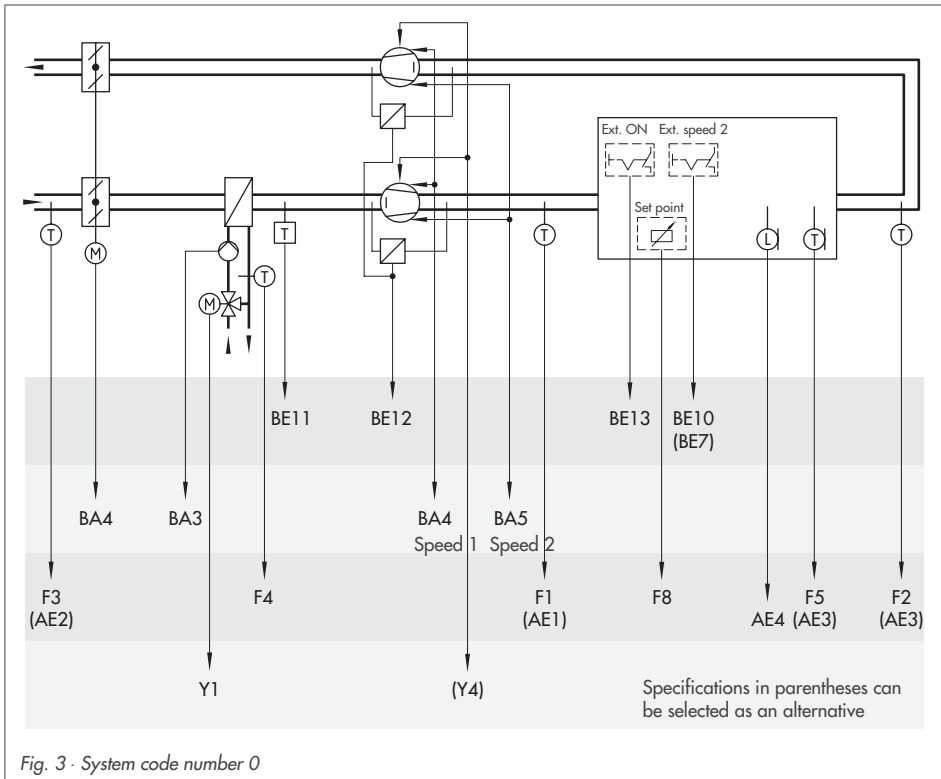

System code number 0 Heating coil control

- ▶ Outdoor temperature-controlled supply air control, see section 5.5.3
- ▶ Fan operation, 2-speed or 0 to 10 V, see section 5.3.3

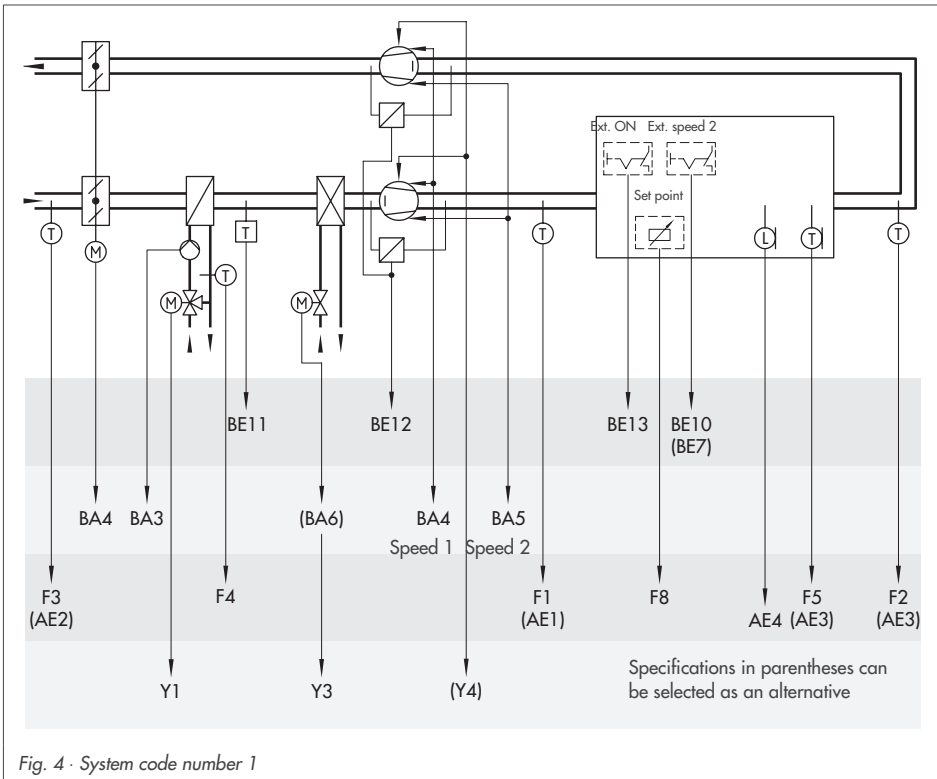

System code number 1 Heating coil and cooling coil control

- ▶ Summer compensation, see section 5.5.2,
- ▶ Sequence operation of heating/cooling or overlapping operation, see section 5.3.6
- ▶ Fan operation, 2-speed or 0 to 10 V, see section 5.3.3

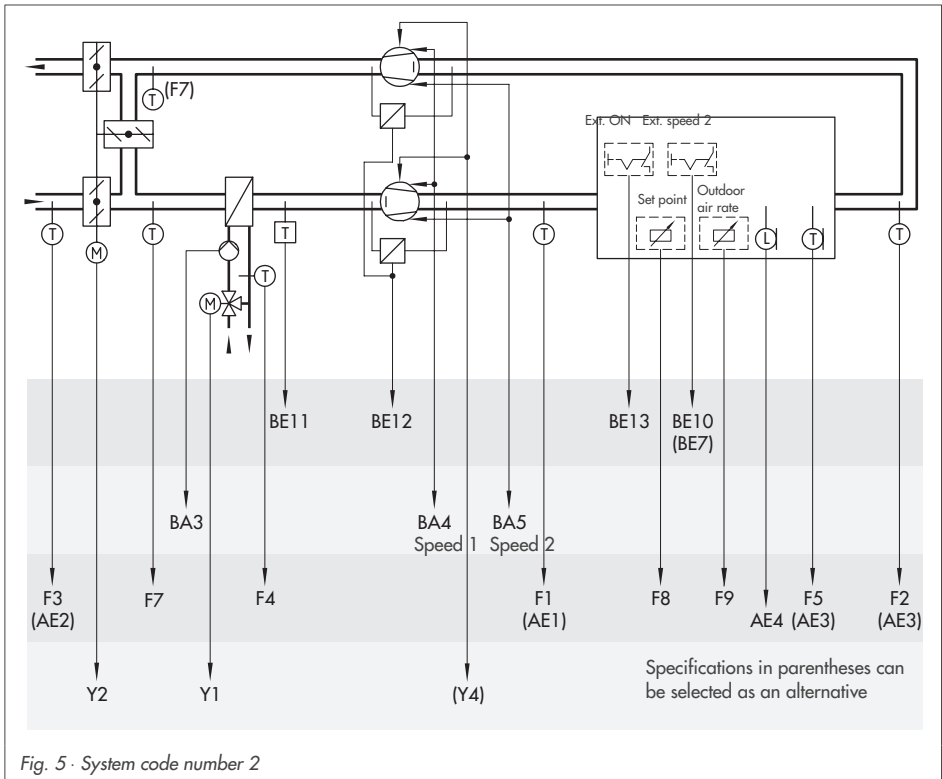

System code number 2

Mixed air chamber and heating coil control

- ▶ Summer time operation, see section 5.4.2,
- ▶ Sequence operation of heating/dampers or mixed air temperature control, see section 5.3.12,
- ▶ Automatic reversal of operating action for mixed air chamber, see section 5.3.12,
- ▶ Fan operation, 2-speed or 0 to 10 V, see section 5.3.3

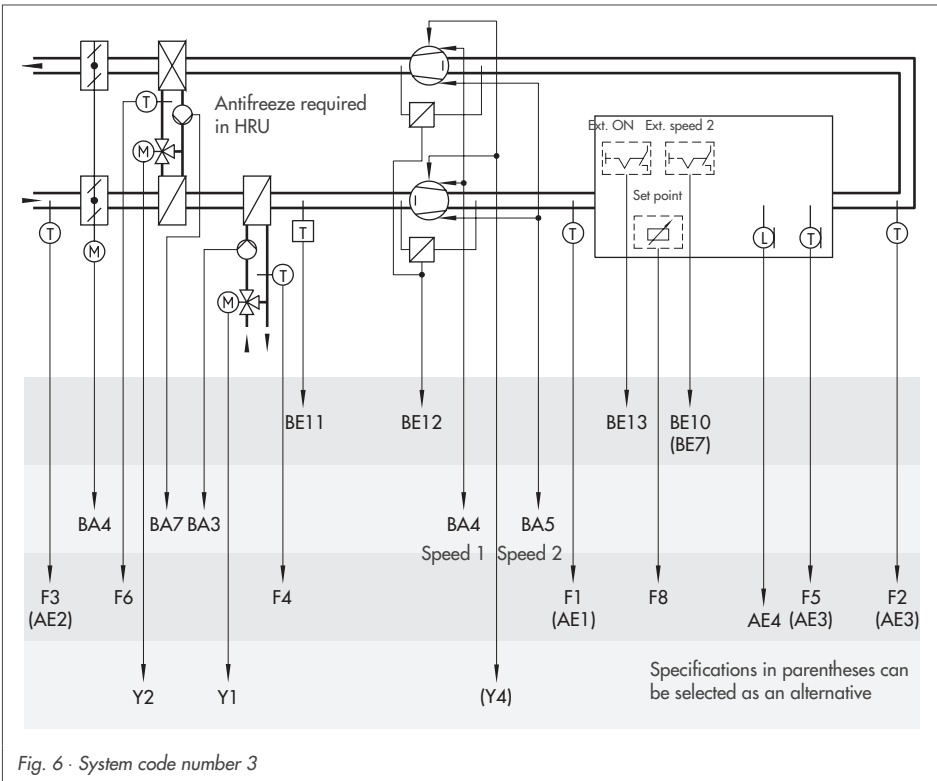

System code number 3 Heat recovery unit (HRU) and heating coil control

- ▶ Frost protection for HRU, see section 5.7.1,
- ▶ Fan operation, 2-speed or 0 to 10 V, see section 5.3.3

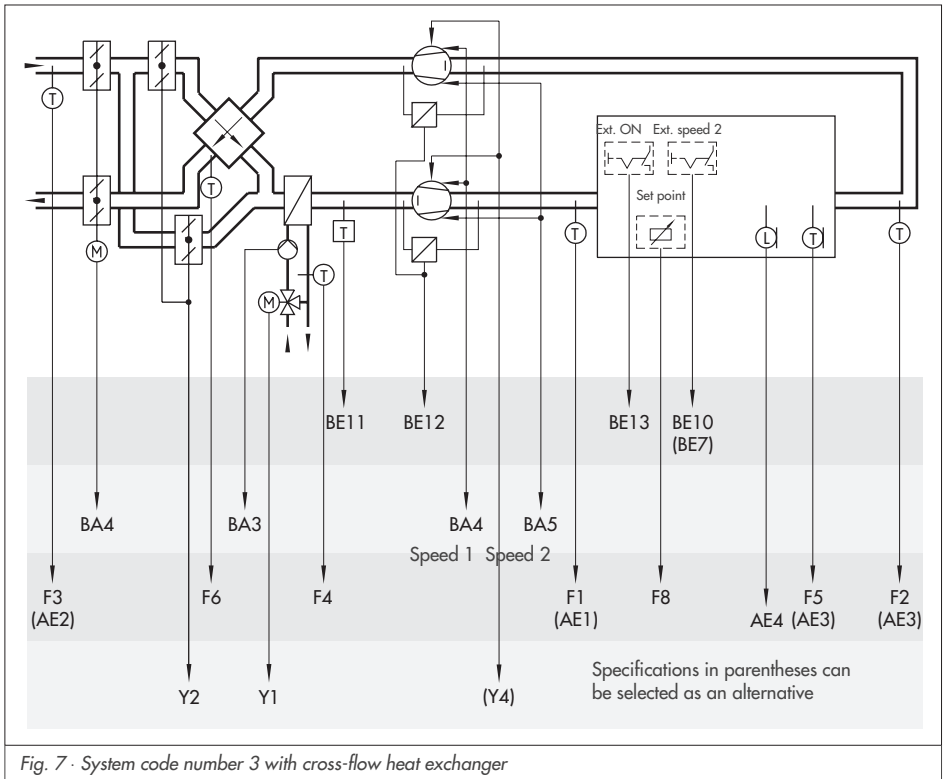

Fig. 7 · System code number 3 with cross-flow heat exchanger

System code number 3 Heat recovery unit (HRU) and heating coil control

- ▶ Heat recovery unit designed as a cross-flow heat exchanger
- ▶ Frost protection for HRU, see section 5.7.1,
- ▶ Fan operation, 2-speed or 0 to 10 V, see section 5.3.3

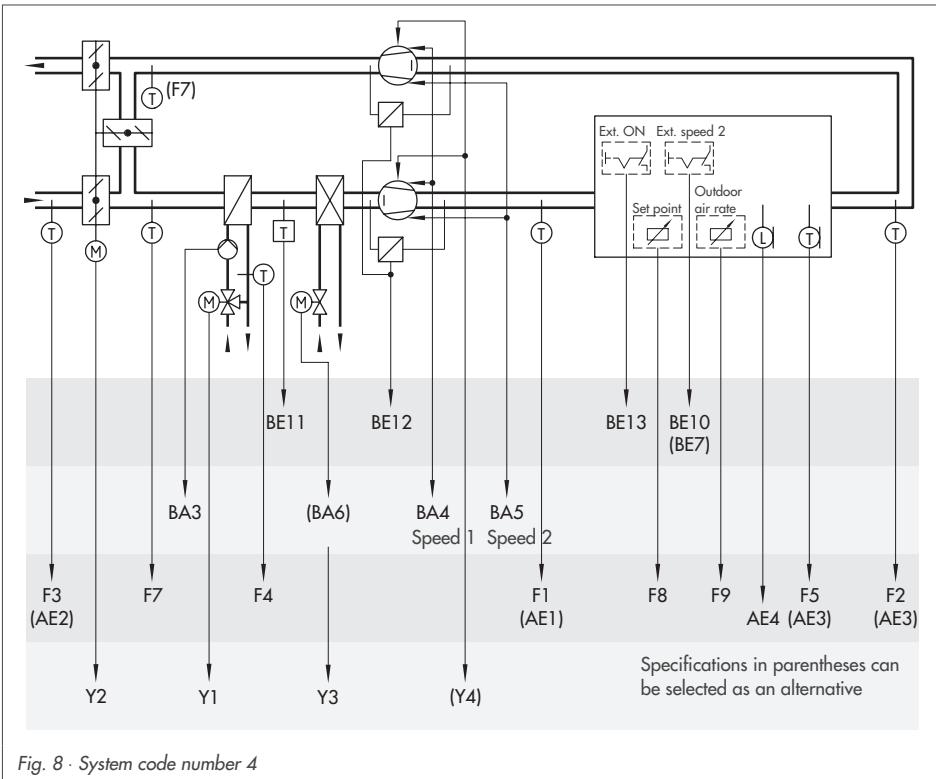
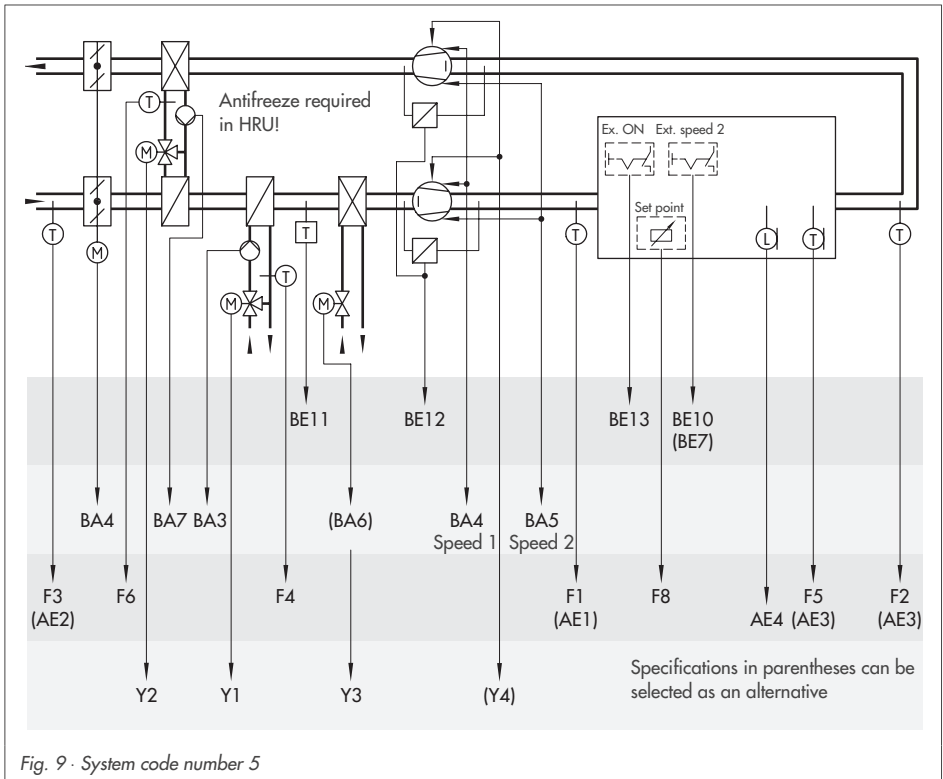

Fig. 8 · System code number 4

System code number 4

Control of mixed air chamber, heating coil and cooling coil

- ▶ Summer compensation, see section 5.5.2,
- ▶ Summer time operations, section 5.4.2,
- ▶ Sequence operation of heating/damper/cooling or sequence operation of heating/cooling and mixed air temperature control, see section 5.3.12
- ▶ Automatic reversal of operating action for mixed air chamber, see section 5.3.12,
- ▶ Fan operation, 2-speed or 0 to 10 V, see section 5.3.3



System code number 5

Control of heat recovery unit (HRU), heating coil and cooling coil

- ▶ Summer compensation, see section 5.5.2,
- ▶ Frost protection for HRU, see section 5.7.1,
- ▶ Fan operation, 2-speed or 0 to 10 V, see section 5.3.3

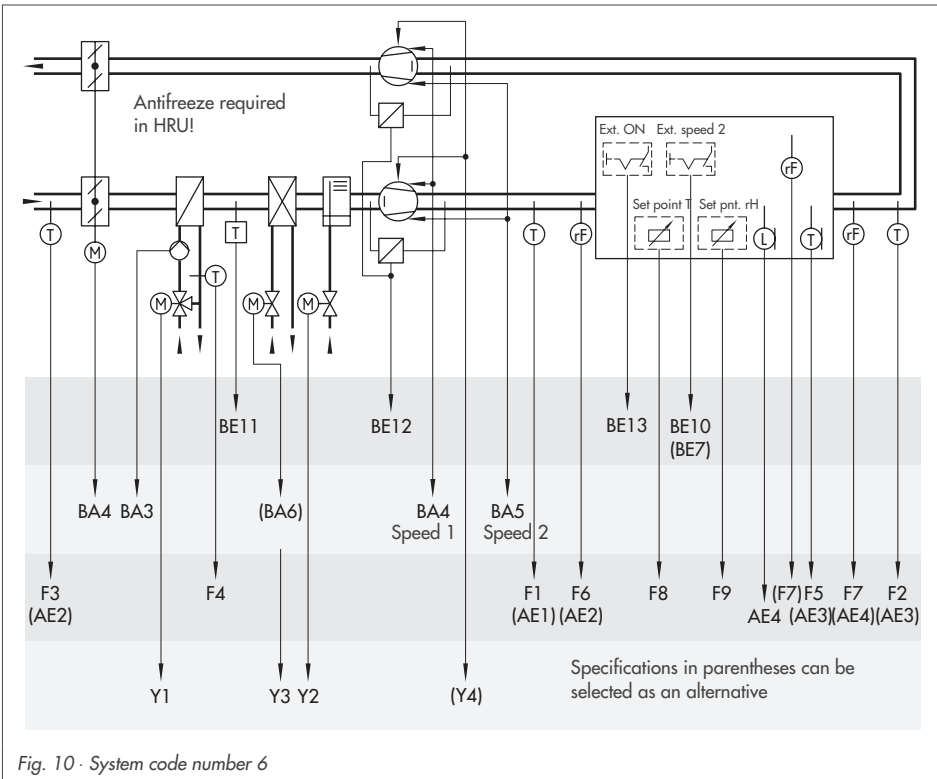

System code number 6 Control of heating coil, cooling coil and humidifier (just humidity)

- ▶ Two control circuits (temperature and humidity control)
- ▶ Humidifying or humidifying and dehumidifying operation configurable, see section 3.3.3 ,
- ▶ Summer compensation, see section 5.5.2,
- ▶ Fan operation, 2-speed or 0 to 10 V, see section 5.3.3

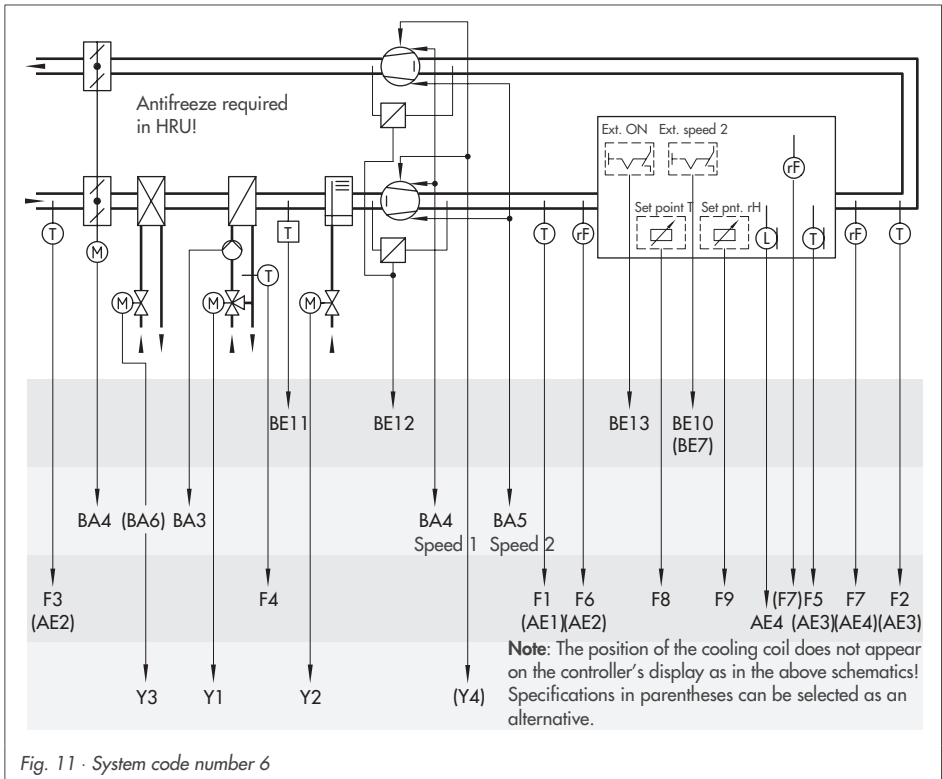

System code number 6

Control of cooling coil, heating coil and humidifier (humidifying and dehumidifying)

- ▶ Two control circuits (temperature and humidity control)
- ▶ Humidifying or humidifying and dehumidifying operation configurable, see section 3.3.3 ,
- ▶ Summer compensation, see section 5.5.2,
- ▶ Fan operation, 2-speed or 0 to 10 V, see section 5.3.3

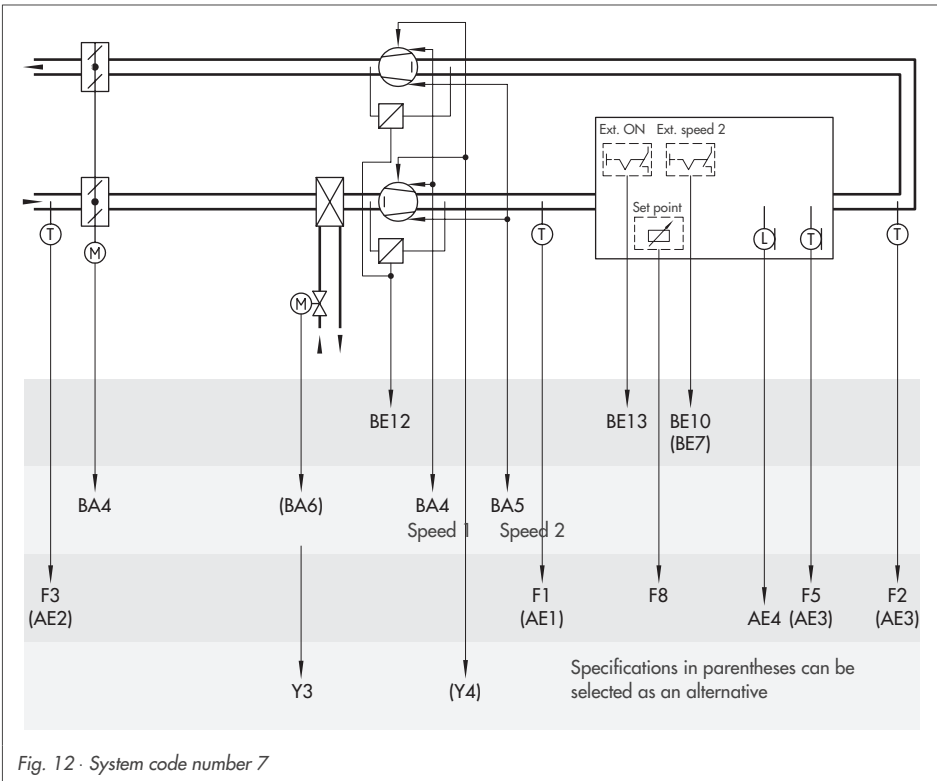

Fig. 12 · System code number 7

System code number 7

Cooling coil control

- ▶ Summer compensation, see section 5.5.2, section 5.3.3
- ▶ Fan operation, 2-speed or 0 to 10 V, see

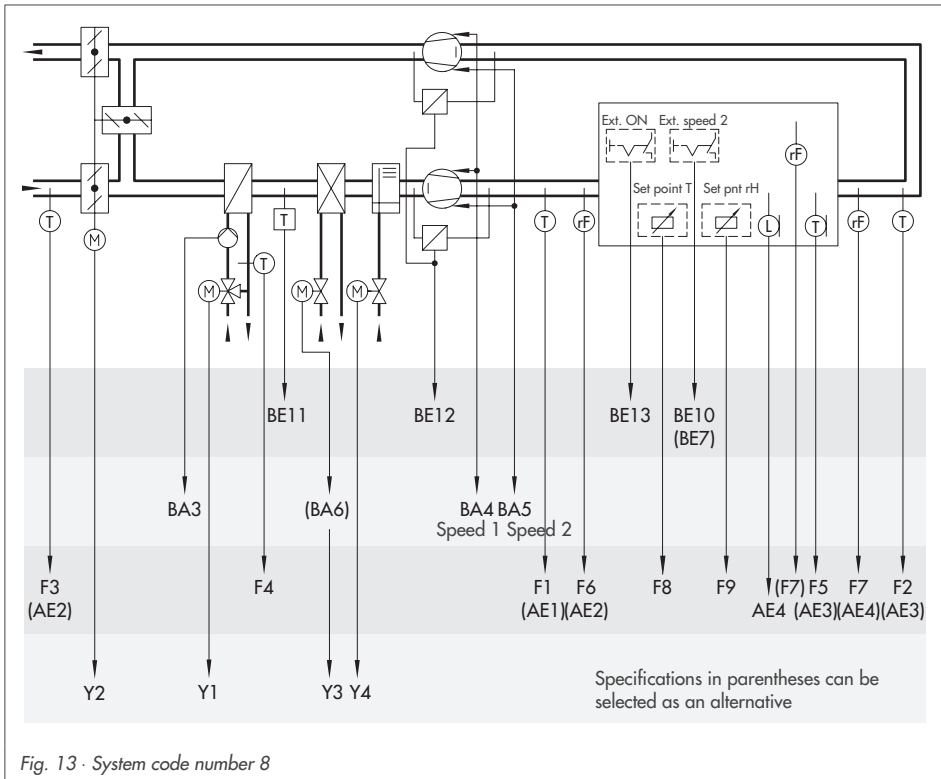
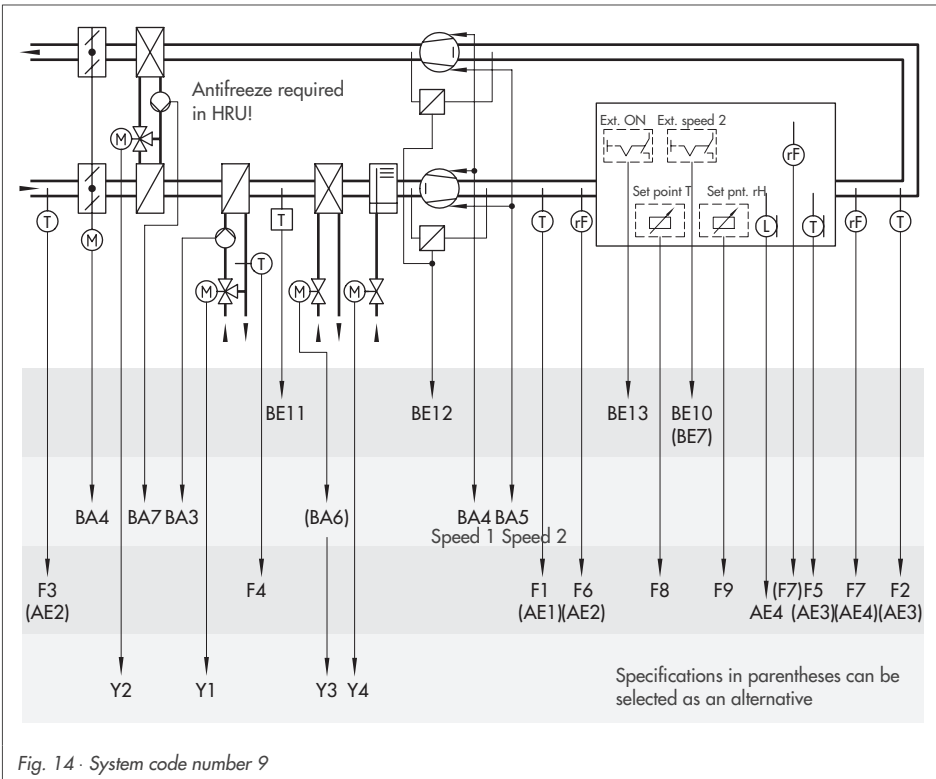

Fig. 13 · System code number 8

System code number 8

Control of mixed air chamber, heating coil, cooling coil and humidifier

- ▶ Two control circuits (temperature and humidity control)
- ▶ Humidifying or humidifying and dehumidifying operation configurable, see section 3.3.3
- ▶ Summer compensation, see section 5.5.2,
- ▶ Summer time operation, see section 5.4.2,
- ▶ Automatic reversal of operating action for mixed air chamber, see section 5.3.12,
- ▶ Fan operation, 2-speed, see section 5.3.3



System code number 9

Control of heat recovery unit (HRU), heating coil, cooling coil and humidifier (only humidification)

- ▶ Two control circuits (temperature and humidity control)
- ▶ Humidifying or humidifying and dehumidifying operation configurable, see section 3.3.3,
- ▶ Summer compensation, see section 5.5.2,
- ▶ Fan operation, 2-speed, see section 5.3.3

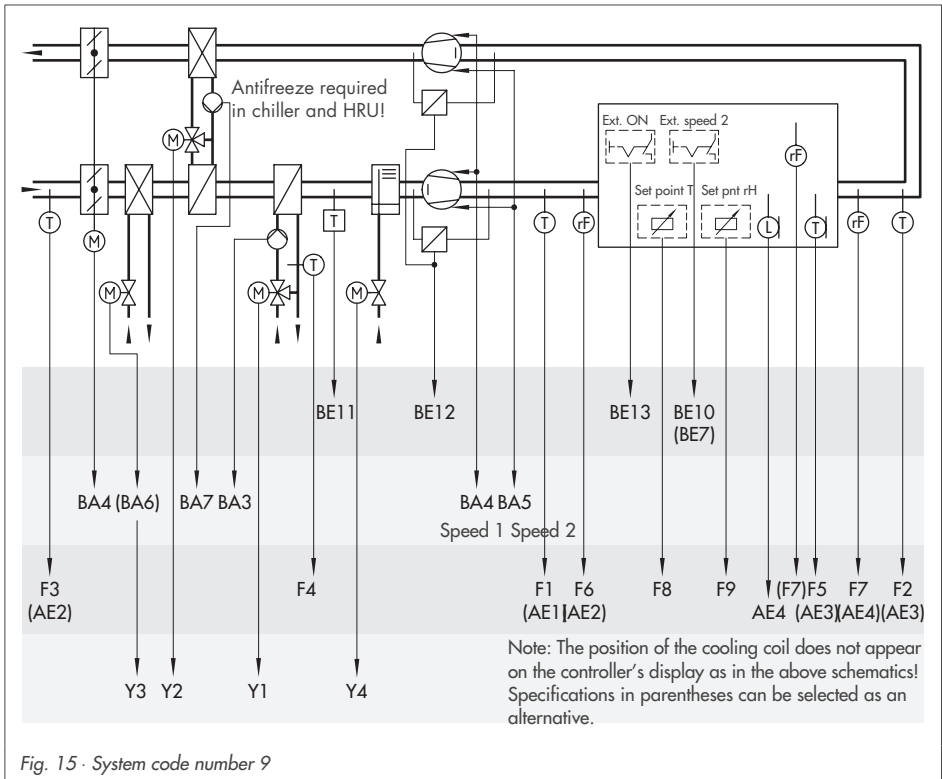

System code number 9

Control of heat recovery unit (HRU), heating coil, cooling coil and humidifier (humidifying and dehumidifying)

- ▶ Two control circuits (temperature and humidity control)
- ▶ Humidifying or humidifying and dehumidifying operation configurable, see section 3.3.3,
- ▶ Summer compensation, see section 5.5.2,
- ▶ Fan operation, 2-speed, see section 5.3.3

5 Function descriptions

The following descriptions assume that you are familiar with the operation of the controller and that you know how to set function blocks, their parameters as well as other

parameters. All the parameters that you can set in the parameter level or in the function blocks are written in italics.

5.1 Control method

You need to determine which control methods are to be used after you have determined the system code number. You can choose between:

- ▶ Supply air temperature control,
- ▶ Exhaust air temperature control,
- ▶ Exhaust air temperature cascade control,
- ▶ Room temperature control or
- ▶ Room temperature cascade control.

For system code numbers An1 6, 8 and 9, the control method for humidity control circuit is set in the same manner as the temperature control circuit. In the humidity control circuit, humidifying and dehumidifying mode or just humidifying mode are **differentiated between**.

Read section 3.3.3 to find out how to set this control method.

5.1.1 Supply air temperature control

The sensor input F1 is the control variable input by default. Alternatively, the supply air temperature can also be guided over the analog input AE1 to the controller.

Select F1 in the function block Co5 Fb18 for AE1.

The supply air temperature is controlled by a PID algorithm with an adjustable *Supply air temperature day set point* or *Supply air temperature night set point* (PA5).

Depending on the system code number, the temperature control circuit has between 1

and 3 sequence outputs that are adapted to the dynamics of the corresponding system components by means of the K_P , T_N and T_V control parameters which can be set in the parameter level (PA1, PA2, PA3).

Functions such as return air temperature limit, summer compensation, manual set point correction or condensation detection can shift the set point. The supply air can be controlled dependent on the outdoor temperature, see section 5.5.3.

5.1.2 Exhaust air temperature control

The sensor input F2 is the control variable input by default. Alternatively, the exhaust air temperature can also be guided over the

analog input AE3 to the controller.

Select F2 in the function block Co5 Fb20 for AE3.

The exhaust air temperature is controlled by a PID algorithm with an adjustable *Exhaust air temperature set point* (PA5).

Depending on the system code number, the temperature control circuit has between 1 and 3 sequence outputs that are adapted to the dynamics of the corresponding system

components by means of the K_P , T_N and T_V control parameters which can be set in the parameter level (PA1, PA2, PA3).

Functions such as return air temperature limit, summer compensation, manual set point correction or condensation detection can shift the set point.

5.1.3 Exhaust air temperature cascade control

The sensor input F2 is the control variable input for the exhaust air temperature and the sensor input F1 is the control variable input for the supply air temperature by default.

Alternatively, you can also change to the analog input AE1 for the supply air temperature by selecting F1 in function block Co5 Fb18 as well as change to the analog input AE3 for the exhaust air temperature by selecting F2 in the function block Co5 Fb20.

The exhaust air temperature control circuit is implemented as a P control circuit with adjustable *Exhaust air temperature day set point*, *Exhaust air temperature night set point* and *K_P Temperature master loop* (PA5). The supply air temperature is controlled by a PID control algorithm with adjustable *Supply air temperature set point slave loop* (= set point of the supply air temperature control, PA5).

Depending on the system code number, the supply air temperature control circuit has between 1 and 3 sequence outputs that are adapted to the dynamics of the corresponding system components by means of the K_P , T_N and T_V control parameters which can be changed in the parameter level (PA1, PA2, PA3). The parameters *Supply air tempera-*

ture minimum limit and *Supply air temperature maximum limit* (PA5) restrict the set point shift which arises when the exhaust air temperature control circuit takes influence on the supply air temperature control circuit: each deviation in exhaust air temperature by the amount x causes a shift of the supply air temperature set point by the amount x multiplied by the parameter *K_P Temperature master loop*.

Example:

<i>Exhaust air temperature set point</i>	= 22 °C
Current exhaust air temperature	= 20 °C
<i>Temperature set point slave loop</i>	= 30 °C
<i>K_P Temperature master loop</i>	= 2.5
<i>Supply air temp. minimum limit</i>	= 40 °C
Temperature set point	
slave loop calculated	= 35 °C

Shifts in the set point which are caused by manual set point correction, return air temperature limit, summer compensation or by condensation detection, have unrestricted effects on the exhaust air temperature set point.

5.1.4 Room temperature control

The sensor input F5 is the control variable input by default. Alternatively, the room temperature can also be guided over the analog input AE3 to the controller.

For this, select F5 for AE3 in function block Co5 Fb20.

The room temperature is controlled by a PID algorithm with an adjustable *Room temperature day set point* or *Room temperature night set point* (PA5).

Depending on the system code number, the

temperature control circuit has between 1 and 3 sequence outputs that are adapted to the dynamics of the corresponding system components by means of the K_P , T_N and T_V control parameters which you can change in the parameter level (PA1, PA2, PA3). Functions such as return air temperature limit, summer compensation, manual set point correction or condensation detection can shift the set point.

5.1.5 Room temperature cascade control

The sensor input F5 is the control variable input for the room temperature and the sensor input F1 is the control variable input for the supply air temperature by default.

Alternatively, you can also change to the analog input AE3 for the room temperature by selecting F5 in function block Co5 Fb20 as well as change to the analog input AE1 for the supply air temperature by selecting F1 in the function block Co5 Fb18.

The room temperature control circuit is implemented as a P control circuit with adjustable *Room temperature day set point*, *Room temperature day night point* and K_P *Temperature master loop* (PA5). The supply air temperature is controlled by a PID control algorithm with adjustable *Temperature set point of the slave loop* (= set point of supply air temperature control).

Depending on the system code number, the temperature control circuit has between 1 and 3 sequence outputs that are adapted to the dynamics of the corresponding system components by means of the K_P , T_N and T_V

control parameters which you can change in the parameter level (PA1, PA2, PA3). The parameters *Supply air temperature minimum limit* and *Supply air temperature maximum limit* restrict the set point shift which arises when the room temperature control circuit takes influence on the supply air temperature control circuit: each deviation in room temperature by the amount x causes a shift of the supply air temperature set point by the amount x multiplied by the parameter K_P *Temperature master loop*.

Example:

<i>Room temperature set point</i>	= 22 °C
<i>Current room temperature</i>	= 20 °C
<i>Supply air temperature set point</i>	= 30 °C
K_P <i>Temperature master loop</i>	= 2.5
<i>Supply air temperature minimum limit</i>	= 40 °C
<i>Supply air temperature set point calculated</i>	= 35 °C

Shifts in the set point which are caused by manual set point correction, return air tem-

perature limit, summer compensation or by condensation detection, have unrestricted effects on the room temperature set point.

5.1.6 Supply air humidity control

The supply air humidity control is only selectable for system code numbers An1 6, 8 and 9.

The sensor input F6 is the control variable input by default. Alternatively, you can also change to the analog input AE2 by selecting F6 in function block Co5 Fb19.

The supply air humidity is controlled by a PID control algorithm with an adjustable *Supply air humidity day set point* or *Supply air humidity day night point* (PA5).

The humidity control circuit can be used for just humidifying or for humidifying and dehumidifying depending on the control method. In humidifying and dehumidifying mode, the

cooling coil is controlled in sequence to the humidifier. The requirements of the humidity control circuit for dehumidifying and the temperature control circuit for cooling are converted internally into a common control signal Y3 for the cooling coil. Each output can be adapted to the dynamics of the corresponding system components by means of the K_P , T_N and T_V control parameters (PA3, PA4) that are adjustable.

A manual set point correction has an unrestricted effect on the control by the shifting the set point.

5.1.7 Exhaust air/room humidity control

The exhaust air or room humidity control is only selectable for system code numbers 6, 8 and 9.

The sensor input F7 is the control variable input by default. Alternatively, you can also change to the analog input AE4 by selecting F7 in function block Co5 Fb21.

The exhaust air or room humidity control is implemented as a PID control algorithm with adjustable *Exhaust air humidity set point* or *Room humidity set point* (PA5).

The humidity control circuit can be used just for humidifying or for humidifying and dehumidifying depending on the control method. In humidifying and dehumidifying mode, the

cooling coil is controlled in sequence to the humidifier. The requirements of the humidity control circuit for dehumidifying and the temperature control circuit for cooling are converted internally into a common control signal Y3 for the cooling coil. Each output can be adapted to the dynamics of the corresponding system components by means of the K_P , T_N and T_V control parameters (PA3, PA4) that are adjustable.

A manual set point correction has an unrestricted effect on the control by the shifting the set point.

5.1.8 Exhaust air or room humidity cascade control

The exhaust air or room humidity cascade control is only selectable for system code numbers 6, 8 and 9.

The sensor input F7 is the control variable input for exhaust air or room humidity and the sensor input F6 is the control variable input for supply air humidity by default. Alternatively, you can also change to the analog input AE4 for the exhaust air or room humidity by selecting F7 in function block Co5 Fb21 as well as change to the analog input AE2 for the supply air humidity by selecting F6 in the function block Co5 Fb19. The master loop has a P control response with adjustable *Exhaust air humidity set point* or *Room humidity set point* and *K_p Humidity master loop* (PA5). The supply air control is implemented by a PID control algorithm with adjustable *Humidity set point of the slave loop* (= set point of the supply air humidity, PA5).

The humidity control circuit can be used either just for humidifying or for humidifying and dehumidifying by involving the cooling coil in sequence to the humidifier. The requirements of the humidity control circuit for dehumidifying and the temperature control circuit for cooling are converted inter-

nally into one common control signal Y3 for the cooling unit. Each output can be adapted to the dynamics of the corresponding system components by means of the *K_p*, *T_N* and *T_V* control parameters (PA3, PA4) that are adjustable.

The set point of the supply air humidity control circuit is shifted depending on the system deviation in the exhaust air or room humidity control circuit:

Each deviation in humidity by the amount *x* shifts the supply air humidity set point by the amount *x* multiplied by the parameter *K_p Humidity master loop* within the range *Supply air humidity minimum limit* and *Supply air humidity maximum limit*.

Example:

- ▶ *Exhaust air humidity set point* = 60 % rH
- ▶ *Current exhaust air humidity* = 54 % rH
- ▶ *Humidity set point of the slave loop* = 70 % rH
- ▶ *K_p Humidity master loop* = 2.5
- ▶ *Supply air humidity maximum limit* = 80 % rH
- ▶ *Humidity set point of the slave loop* _{calculated} = 80 % rH

5.2 Inputs

The assignment of the inputs depends on the system code number and the control method. See section 4 for this assignment in the system diagrams. Alternatively, you can also assign analog inputs to the resistance sensors. The four analog inputs (0 to 10 V) are suitable for active temperature, humidity and

air quality sensors.

Sensors which are required for the selected control methods are always activated. You must determine separately all the other sensors as well as the functions of the binary inputs by configuring them.

5.2.1 Setting the type of sensor (Co6 Fb00...Fb13)

The ventilation controller can process signals either from Pt 100 sensors and PTC sensors or from Pt 100 sensors and Pt 1000 sensors. Select which type of sensor is to be used in function block Fb00. Fb00 = OFF means Pt 100 and PTC sensors are used; Fb00 = ON means Pt 100 and Pt 1000 sensors are used. If some of the sensor inputs are not the same as the assignment set in Fb00, the function blocks 01 to 13 for the sensor inputs F1 to

F13 must be activated (see Fig. 30 on page 92). On activating the sensor inputs, the type of sensor must be selected. The following appears: n1000 (Ni1000), ni200, nTC, PtC, P1000 (Pt 1000), Pt100, 4-20 (mA), 0-20 (mA).

Connect 50 Ω resistance in parallel for a current signal!

5.2.2 Calibrating the sensor (Co6 Fb23)

The values measured by all the connected sensors can be calibrated within a small tolerance range. To calibrate the sensors, proceed as follows:

Activate Fb23 in Co6 level. This is only possible after the key code has been entered!

↑ Use the arrow key to select the function block for the sensor you want to calibrate, e.g. Fb03 for outdoor sensor F3.

Note: Fb number matches the input numbers (see Fig. 30, p.92).

* Press enter key twice. The temperature appears on the display.

* Press the enter key. The indicated

↑
or
↓

*

*

temperature starts to blink.

Use arrow keys to set new value.

Press enter key to confirm this value. **End** appears on the display.

Press the enter key. The next Fb appears on the display.

If required, calibrate further sensor inputs. Do not forget to deactivate Fb23 when you have finished calibrating all the sensors!

Note: Values from the sensor calibration are not reset to default settings after a reset or after the system code number has been changed!

5.2.3 Analog inputs (Co5 Fb18...Fb21)

You can assign the four analog inputs AE1 to AE4 to temperature sensors, humidity sensors or an air quality sensor. Refer to the system diagrams in section 4 for possible assignments. They are listed underneath the resistance sensors in parentheses. If you want to use analog inputs, activate the corresponding function block Fb18...Fb21 before assigning the sensors. The following options appear on the display:

- ▶ Supply air temperature F1 (AE1F1)
- ▶ Exhaust air temperature F2 (AE3F2)

- ▶ Outdoor temperature F3 (AE2F3)
- ▶ Room temperature F5 (AE3F5)
- ▶ Supply air humidity F6 (AE2F6)
- ▶ Exhaust air or room humidity F7 (AE4F7)
- ▶ Air quality L (AE1L)

After assigning an analog input, the lower range (MIN) and upper range (MAX) of the measuring range appear on the display. You can change both of these values. Refer to the configuration table in Appendix A on page 99 for the measuring ranges.

5.2.4 Binary inputs



External demand for operation (Co5 Fb13, BE13, BE10)

If you activate the function block Co5 Fb13, you can start the operation of the ventilation system with the binary input BE13.

When the mode switch is switched to , the following applies:

- ▶ BE13 = OFF: Ventilation system operation according to the times-of-use
- ▶ BE13 = ON: Ventilation system operation, however, the system cannot be switched off during a time-of-use period by BE13= OFF. If the binary output BE10 is not used for any other purposes, you can switch off the system even during a

time-of-use over BE10 = ON.

When the mode switch is switched to  or to  the following applies:

- ▶ BE13= OFF: Ventilation system not in operation
- ▶ BE13= ON: Ventilation system operation, however, only during a time-of-use set for automatic operation

The system starts up, if necessary, taking into account the system start-up mode. This causes the fans to be switched on after a delay, if required.

External demand for fan speed 2 (Co4 Fb03, BE10/BE7)



You can select the function for external demand for fan speed 2 by activating Co4 Fb03. Following this, you must determine whether the binary input BE10 or BE7

switches the fan to speed 2. The binary input performs then the following function: If the system is running and a time-of-use for the fan speed 2 (PA4) does not exist:

- ▶ BE10/7 = ON: Speed 2 is switched on
 - ▶ BE10/7 = Off: Speed 2 is switched off.
- If the system is switched off, the binary input only allows a preliminary choice. After the system is switched on either due to the time-of-use starting or due to an external demand for operation, the following settings are possible:
- ▶ Speed 1 switched on, when BE10/7 = OFF or
 - ▶ Speed 2 switched on, when

Fan operation feedback (Co4 Fb01, BE12)

Activate the function block Co4 Fb01 to allow the operation feedback of the fans to be evaluated with the binary input BE12. If the floating BE2 input makes contact – after the fans are enabled and the delay time has elapsed, i.e., the fans are not running, – the ventilation system is switched off. The function block parameter *Delay time* can be set to max. 180 seconds. **STOP** blinks on the display when the controller is in the operating level. First when the next time-of-use starts, a new attempt to start is made automatically. You can try to start the ventilation system manually by:

- ▶ Setting the mode switch (A) briefly to  and then back to ,

System frost protection (Co5 Fb15)

Refer to section 5.7.1

Condensation detection (Co3 Fb01, BE10/BE7)

In all systems with cooling coil without a dehumidifying function, a condensation monitor can be activated for chilled ceilings. As

BE10/7 = ON

Note that the function is only available when Co4 Fb02 is activated.

It is possible to switch the system off even during a time-of-use of fan speed 2 with BE10 = ON under the following conditions:

- ▶ Co5 Fb13 = ON
- ▶ Automatic operation
- ▶ External demand for fan speed 2 over Co4 Fb03 = ON, BE7 selected.

- ▶ Triggering an external demand for operation or
- ▶ Switching on the BE12 for at least one second using an external key.

If you use the binary input BE12 for another purpose other than external demand for operation, it is still possible to switch off the system within the times-of-use by deactivating BE12. However, **STOP** blinks on the display to indicate an error in the operating level. If you then activate the binary input BE12 again, the system starts without the system start-up mode!

The binary input BE12 is a floating make contact.

soon as condensation is detected in standard operation, the set point of the control is raised by 3 °C. If the condensation monitor

indicates a normal status again, the set point correction is reset.

For analysis of condensation detection, activate Co3 Fb01. Following this, select either binary input BE10 or BE7 for this function. Should only one of the inputs be available

for selection, the input BE10/F10 or BE7/F7 is already in use for another function. Additionally, determine whether the controller is to react to a make contact (setting StEIG) or to a break contact (setting FALL).

5.2.5 Analog inputs

External temperature set point correction (Co5 Fb08)

The set point can be changed either at the set point correction switch (F) or at a potentiometer connected to input F8. Activate the function block Co5 Fb08 for the F8 input.

A correction is possible in the range from -5 K (potentiometer setting 1000Ω) to $+5$ K (potentiometer setting 2000Ω), provided the

supply air temperature limit determined by the supply air temperature control permits it. The potentiometer F8 and the set point correction switch both have an effect on the temperature set points. The set point is changed at the correction switch in ± 1 K steps from one to the next switch position.

External setting of the outdoor air rate (Co5 Fb09, PA2)

The outdoor air rate can be determined at the input F9 with a potentiometer. For this, activate the function block Co5 Fb09. The outdoor air rate is then determined between the

value *Minimum outdoor air rate* (PA2, potentiometer setting 1000Ω) and 100% (potentiometer setting 2000Ω).

External correction of the humidity set point (Co5 Fb09)

In all air-conditioning systems, the humidity set point can be determined at the input F9 with a potentiometer. For this, activate the function block Co5 Fb09. The humidity set point is then determined between -20% rH

(potentiometer setting 1000Ω) and $+20\%$ rH (potentiometer setting 2000Ω), provided the supply air limit of the supply air humidity control permits it.

5.3 Outputs

5.3.1 Circulation pump control for the heating coil (BA3)

The circulation pump of the heating coil is controlled by the binary output BA3. If the system goes into operation due to the time schedule of the ventilation with the system start-up mode, the circulating pump is switched on before the time-of-use starts at the time set under *Pump advance running time for start-up* (PA1).

Without the system start-up mode, the circulation pump is activated at the earliest when the time-of-use begins. In systems with an outdoor temperature sensor, the circulation pump's operation depends on the parameter *Start-up when the outdoor temperature is lower*. If the outdoor temperature is above

this limit value and the control signal Y1 is 0 % for approximately three minutes, the circulation pump is switched off. First when $Y1 > 0\%$, it is activated again. At the start of a time-of non-use (system deactivation) the circulation pump of the heating coil is switched off after three minutes lag time, provided there is no demand for operation or stand-by control. During the summer deactivation, the circulation pump of the heating coil is basically switched off. It is activated daily for approximately one minute to prevent it from becoming jammed up.

5.3.2 Enabling fan speed 1 (BA4)

Usually, the fan speed 1 is enabled over the binary output BA4 at the programmed start of the time-of-use (*Times-of-use of the system* PA5). The system start-up mode has already been completed, if necessary, at the time period set under *Pump advance running time for start-up* (PA1) before the time-of-use starts. When a request for an externally required signal is issued, the fan speed 1 may be enabled with a delay due to the sys-

tem start-up mode.

If the outdoor air/outgoing air damper is additionally to be controlled over BA4, it will be necessary to determine in function block Co4 Fb02 that BA4 also remains activated when fan speed 2 is in operation. In case of the malfunctions "system frost protection" or "missing fan feedback", the fans are immediately switched off.

5.3.3 Enabling fan speed 2 (Co4 Fb02, BA5)

The fan speed 2 is controlled via the binary output BA5. It is enabled either:

- ▶ by *Times-of-use for fan speed 2*,
- ▶ by an external demand for fan speed 2, see section 5.2.4,
- ▶ dependent on the air quality.

Activate the function block Co4 Fb02 for the operation of the two-speed fans. You can then choose between two relay switching options for demanding speed 2. A combination of one or two squares appears at the top of the display below the right-side of the num-

bers 4 or 5 (for BA4, BA5):

- ▶ BA4 = BA5 = ON or
- ▶ BA4 = OFF, BA5 = ON

If the outdoor air/outgoing air damper is additionally to be controlled over BA4, it will be necessary that BA4 also remains activated when fan speed 2 is in operation.

Following this, you are prompted to set a *Delay time* up to 60 seconds. After fan speed

2 has been demanded when the system is on stand-by, first fan speed 1 is enabled; speed 2 is only enabled after the *Delay time* has elapsed. When the speed 2 is switched back to speed 1, the fans are switched off; speed 1 is only enabled after the *Delay time* has elapsed. The *Delay time* is still taken into account even if the fans are switched on in the manual mode.

Fan speed dependent on the air quality (Co5 Fb18...21, PA4)

Configure an analog input for processing the air quality L in function block Co5 Fb18, 19, 20 or 21 as well as set the following parameter in PA4:

- ▶ *Air quality set point*,
- ▶ *Differential gap of speed 2 → 1*

If the air quality falls below the *Air quality set point*, the operation of fan speed 2 is

demand. The fans are switched back to fan speed 1 when the air quality has risen to a value greater than *Air quality set point + Differential gap of speed 2 → 1*, provided that the *Times-of-use for fan speed 2 (PA4)* or the external demand for fan speed 2 do not require the opposite.

5.3.4 Enabling the cold storage (Co3 Fb12, BA6)

In all systems with cooling coil, the binary output BA6 can be used to enable the charging of a cold storage. Deactivate Co3 Fb12 and set the function block parameter *Enabling the cold storage at outdoor temperature*. If the

outdoor temperature measured over an hour exceeds the value *Enabling the cold storage at outdoor temperature*, BA6 is switched on. If the value falls below the limit for an hour, BA6 is switched off.

5.3.5 Binary output dependent on Y3 (Co3 Fb12, BA6)

In all systems with cooling coil, the binary output BA6 can be activated dependent on the control signal Y3. It can, for example, control a direct expansion evaporator.

For this, activate Co3 Fb12 and select SEQ. Following this, both function block parameters require setting:

- ▶ Activating value (START): % of Y3 value, at which BA6 is activated;
- ▶ Deactivating value (STOP): % of Y3 value, at which BA6 is deactivated.

The control signal Y3 is available in parallel for this function!

5.3.6 Controlling the chiller (Co3 Fb12, BA6)

In all systems with cooling coil (except for Anl 7), a chiller can be run to overlap, i.e. in parallel to the other system elements operating in sequence.

Activate for this Co3 Fb12 and then select PAr. Following this, three function block parameters require setting:

- ▶ *Minimum activated time*: Minimum running time that the chiller runs after demand
- ▶ *Minimum deactivated time*: Interval between operation after the chiller has been switched off
- ▶ *Deactivate cooling*: Heating coil control signal Y1 at which the chiller is switched off after *Minimum activated time*

As soon as a low temperature is requested, the chiller is activated at least for the period determined under *Minimum activated time*. The other system elements can be requested

in parallel to the chiller. An excess amount of cold air is at first compensated for by the HRU and heating coil. If the heating coil control signal Y1 exceeds the value *Deactivate cooling*, the chiller is switched off at least for the time period determined under *Minimum deactivated time*. When the outdoor temperature is fed forward, the chiller basically is only enabled when the outdoor temperature is 3°C higher than the current set point – with a cascade control, higher than the current supply air set point. A chiller that is running is deactivated when $Y1 > 0\%$ observing the *Minimum activation time*, if the outdoor temperature is lower than the set point; with outdoor temperatures higher than the set point depending on the parameter *Deactivate cooling*.

The control signal Y3 is not available.

5.3.7 Circulation pump control for the HRU (BA7)

In systems with connected heat recovery unit (Anl 3, Anl 5 and Anl 9), the binary output BA7 controls the HRU pump. This pump is only activated when the control signal is $Y2 > 0\%$. If Y2 is 0% for longer than three minutes when the system is in operation, the circulation pump is switched off. First when

$Y2 > 0\%$ it is switched on again. If the time-of-use finishes, the HRU pump is switched off after three minutes. The HRU pump is activated at least once for approximately one minute every 24 hours to prevent it from becoming jammed up.

5.3.8 On/off output for heating coil (Co1 Fb12, BA7)

The binary output BA7 can also be used to control an electric air heater in on/off operation instead of the HRU pump. BA7 is then controlled depending on the control signal Y1. Activate Co1 Fb12 and determine the

following function block parameters:

- ▶ Activating value (START): % of Y1 value, at which BA7 is activated,
- ▶ Deactivating value (STOP): % of Y1 value, at which BA7 is deactivated.

The control signal Y1 is available in parallel for this function!

5.3.9 Three-step output for heating coil (Co1 Fb13; BA6, BA7)

In system Anl 0, the heating coil can alternatively be controlled with a three-step output. The binary output BA7 then controls the operating action OPENING and the binary output

BA6 the operating action CLOSING. If you want to use this function, activate Co1 Fb13 and determine the function block parameter *Valve running time*.

5.3.10 Fault alarm output (BA1)

The binary output BA1 is an open collector output. It is activated when the status register FSR is > 0 . A maximum of 24 V DC may be

applied to this output; the electric current should not exceed 100 mA when connected.

5.3.11 Heating coil (Y1, Co1 Fb21)

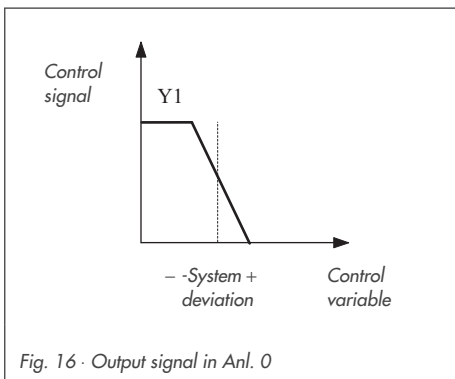

T_N Heating coil and T_V Heating coil (PA1). The operating action of the control output Y1 can be reversed. The default setting of the operating action: heating capacity 0 to 100% = 0 to 10 V. Activate Co1 Fb21 to reverse it to heating capacity 0 to 100% = 10 to 0 V.

An electric air heater can be controlled via the binary output BA5 subject to Y1, see section 5.3.8

The heating coil can alternatively be controlled over a three-step output in system Anl 0, see section 5.3.9.

The heating coil is controlled from the control output Y1. The heating coil control is implemented by a PID control algorithm with the adjustable parameters K_P Heating coil,

5.3.12 Mixed air chamber (Y2, Co5 Fb07, Co2 Fb21, PA2)

You can choose between three operating modes for operation of the mixed air chamber:

- ▶ Mixed air chamber in sequential operation
- ▶ Independent mixed air temperature control or

- ▶ Outdoor temperature-controlled mixed air chamber.

The mixed air chamber is controlled from the control output Y2.

Mixed air chamber in sequential operation (Fig. 17)

For this mixed air chamber mode, select Co5 Fb07 = OFF, and then select SEQ (sequential operation) or Co5 Fb07 = ON, and then select SEQ (sequential operation with outgoing air temperature). The mixed air chamber is controlled from the Y2 output which can be adapted to the dynamics of the mixed air chamber by means of the parameters K_p Mixed air chamber, T_N Mixed air chamber and T_v Mixed air chamber. The parameter *Minimum outdoor air rate (PA2)* guarantees an minimum proportion of outdoor air.

The operating action of the control output Y2 can be reversed. The default setting is an outdoor air rate of 0 to 100 % which corre-

cted to the outdoor air rate of 0 to 100 % which corre-

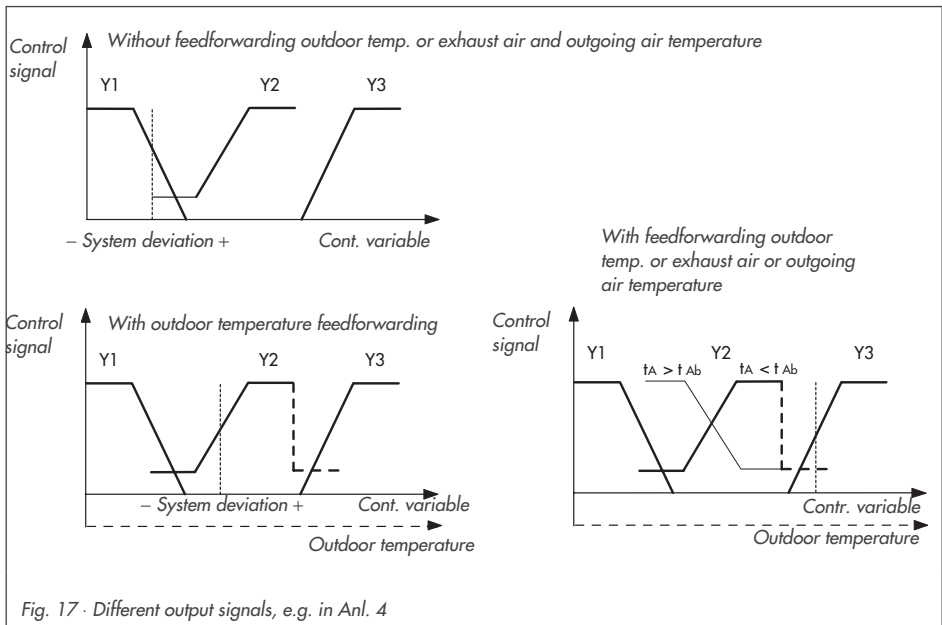

Fig. 17 · Different output signals, e.g. in Anl. 4

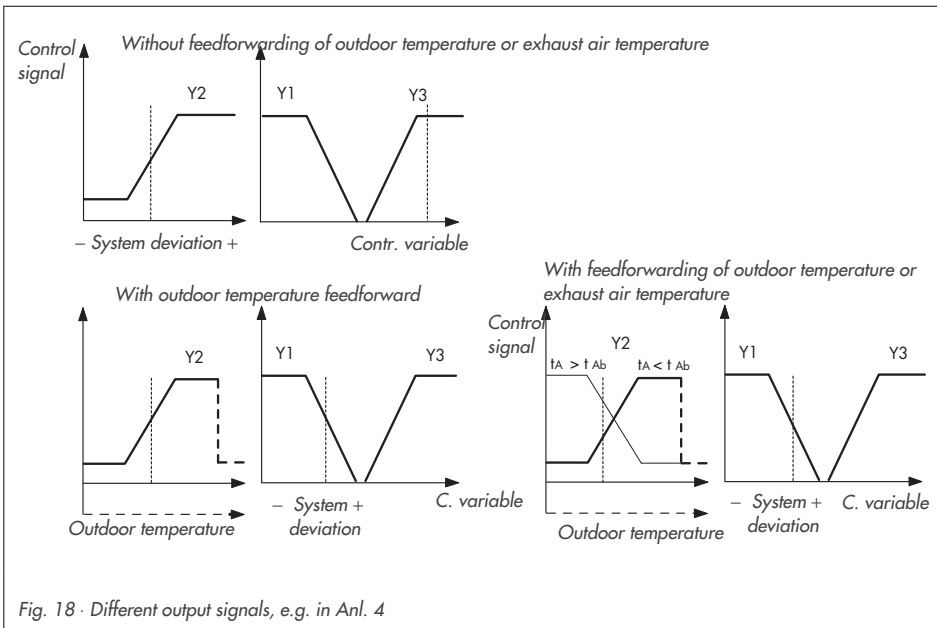

Fig. 18 · Different output signals, e.g. in Anl. 4

sponds to a control signal of 0 to 10 V. Activate function block Co2 Fb21 to reverse the operating action: the outdoor air rate 0 to 100 % then corresponds to 10 to 0 V. On feedforwarding the outdoor temperature, the summer time operation function is taken into account, see section 5.4.2. By additionally feedforwarding the exhaust air temperature, the automatic reversal of the operating action takes effect. If there is a considerable difference in temperature between exhaust air and extract air due to the heat

given off by the fan, the extract air temperature can also be selected as the measured variable in place of the exhaust air temperature. Activate for this Co5 Fb07 and then select SEQ.

If the operating action of the control output Y2 is automatically reversed due to changing temperatures, while the control is in the sequence range Y1 or Y3, the mixed air chamber is then reversed with a constant changing rate of 15 % per minute.

Independent mixed air temperature control (Fig. 18)

You can achieve the independent mixed air temperature control by activating Co5 Fb07 and then selecting mixed air sensor. The inde-

pendent mixed air temperature control is implemented by a PID control algorithm with adjustable *Mixed air temperature set point*.

The output Y2 is adapted to the dynamics of the mixed air chamber with the parameters K_P *Mixed air chamber*, T_N *Mixed air chamber* and T_V *Mixed air chamber* (PA2). The parameter *Minimum outdoor air rate* (PA2) guarantees a minimum proportion of outdoor air.

The operating action of the control output Y2 can be reversed. The default setting is an outdoor air rate of 0 to 100 % which correspond to a control signal of 0 to 10 V. By

activating the function block Co2 Fb21, the operating action is reversed: an outdoor air rate 0 to 100 % corresponds to 10 to 0 V. On feedforwarding the outdoor temperature, the summer time operation function is taken into account, see section 5.4.2.

By additionally feedforwarding the exhaust temperature, the automatic reversal of the operating action takes effect.

Outdoor temperature-controlled mixed air chamber

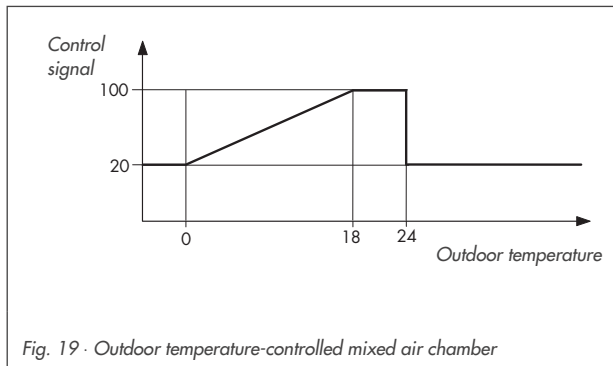

Fig. 19 · Outdoor temperature-controlled mixed air chamber

basic values are determined with the parameters *Minimum outdoor air rate when the outdoor temperature is lower* and *100 % outdoor when the outdoor temperature is greater* (PA2) which results in a characteristic curve for controlling the mixed air chamber. The parameter *Minimum outdoor air rate* (PA2) guarantees the required minimum proportion

of the outdoor air. You can achieve the outdoor temperature-controlled mixed air temperature control by deactivating Co5 Fb07 and then selecting "At". For the outdoor temperature-controlled mixed air chamber, two outdoor temperature

of the outdoor air. The summer time operation (see section 5.4.2) is always available with this operation mode.

5.3.13 Heat recovery unit (Y2, Co2 Fb21)

The heat recovery unit is controlled from the control output Y2. It is implemented by a PID control algorithm with the parameters K_P HRU, T_N HRU and T_V HRU (PA2).

The operating action of the control output Y2 can be reversed.

The default setting is a heat recovery capacity of 0 to 100 % which corresponds to a control signal from 0 to 10 V. By activating the function block Co1 Fb21, the operating action is reversed: HRU capacity 0 to 100 % then corresponds to 10 to 0 V.

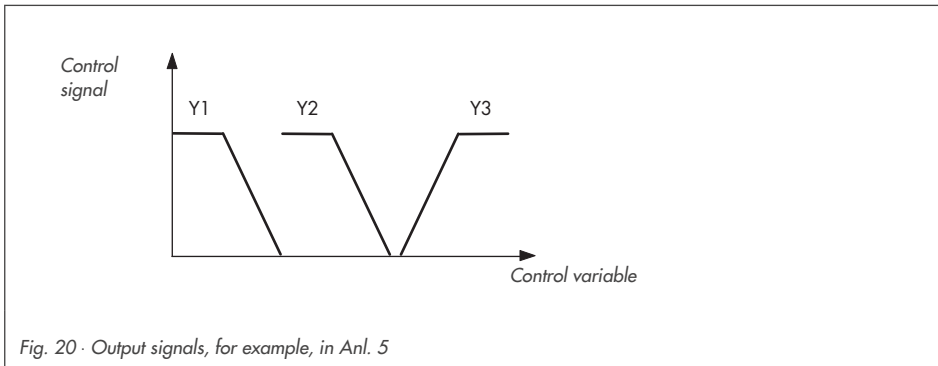

Fig. 20 · Output signals, for example, in Anl. 5

5.3.14 Humidifier (Y2,Y4, Co4Fb21)

The humidifier is controlled in system code number Anl 6 from the control output Y2 and in system code numbers Anl 8 and 9 from Y4. The allocation of the control output Y2 to the humidifier shown in the controller display does not apply to system code numbers Anl 8 and 9!

The humidifier control is implemented by a PID control algorithm with the parameters

K_P Humidifier, T_N Humidifier and T_V Humidifier (PA4).

The operating action of the humidifier can be reversed. The default setting is a humidifier capacity of 0 to 100 % which corresponds to a control signal of 0 to 10 V. By activating the function block Co4Fb21, the operating action is reversed: a humidifier capacity 0 to 100 % then corresponds to 10 to 0 V.

5.3.15 Cooling coil (Y3)

The cooling coil is controlled from the control output Y3. It is implemented by a PID control

algorithm with the parameters K_P Cooling coil, T_N Cooling coil and T_V Cooling coil.

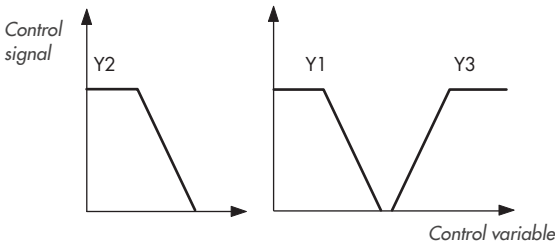

Fig. 22 · Output signals, for example, in Anl. 6 (humidifier only)

In the system code numbers Anl 6, 8 and 9, the demands made by the humidity control circuit for humidifying or the temperature control circuit for cooling are converted internally into one common control signal Y3 for the cooling coil.

The operating action of the control output Y3 can be reversed. The default setting is a cooling capacity of 0 to 100 % which corresponds to a control signal from 0 to 10 V. By activating the function block Co3Fb21,

the operating action is reversed: the cooling capacity 0 to 100 % then corresponds to 10 to 0 V.

Cooling can also be controlled using an on/off signal which is issued at the binary output BA6 (see section 5.3.5). Control of a chiller is likewise possible (see section 5.3.6).

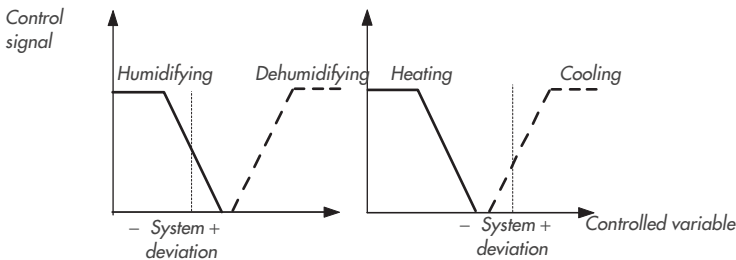

Fig. 21 · Output signals, for example, in Anl. 6 (humidifying and dehumidifying)

5.3.16 Air volume control (Co4Fb04, Fb20; Co5Fb18...21, Y4)

The control output Y4 can be used to control the speed of the fans and the air volume based on the air quality. Activate for this Co4Fb04 and allocate an analog input for measuring the air quality L in function block Co5 Fb18..Fb21.

The following parameters must additionally be set:

- ▶ The function block parameter *Minimum air volume flow* in function block Co4Fb04, and if applicable, for cascade control *Factor of change K_P*,
 - ▶ *Air quality set point* in the PA4 level.
- If the air quality falls below the parameter *Air quality set point*, the air volume is increased based on the *Minimum air volume flow*.

When an exhaust air cascade control or a room temperature cascade control is used, the controller can be programmed so that the air volume is increased when the supply air temperature limit is reached to eliminate the system deviation as quickly as possible. This function has priority over the air quality control. After the system deviation has been balanced out, the air quality control is enabled again. You can activate this function by set-

ting *Factor of change K_P* not equal to 0.

Example:

Exhaust air temperature set point = 22 °C

Current exhaust air temperature = 24 °C

Factor of change K_P = 5

Current supply air temperature = 18 °C

Supply air temperature min = 18 °C

For Y4 = 50 %

$Y4_{new} = Y + XD \cdot K_P$

= 50% + (24 °C - 22 °C) ÷ 40 °C · 100% · 5

= 75%

(XD is the percentage error in relation to the measuring range. Its maximum limit is 10 %).

The air quality control is implemented by a PI control algorithm with the parameters *K_P Air quality control* and *T_N Air quality control* (PA4).

The operating action of the air quality input can be reversed. The default setting is an air quality of 0 to 100 % which corresponds to an input signal of 0 to 10 V. L 0 means an insufficient air quality. By activating the function block Co4Fb20, the operating action is reversed: air quality 0 to 100 % then corresponds to 10 to 0 V. As a result, L 0 means a very good air quality.

5.3.17 Request for externally required signal over LON (Co1Fb01)

This function allows you to request the required flow temperature from a primary controller in complex systems. The required flow temperature is superimposed on the LON bus. Activate the request for externally required signal function over the function block Co1Fb01 = ON. Following this, set the function block parameters listed below:

- ▶ *Flow requirement MIN*
- ▶ *Flow requirement MAX*
- ▶ *Change when Y1 MIN*
- ▶ *Change when Y1 MAX*

The required flow temperature is calculated from the heating coil control signal: If this exceeds in standard operation the limit value *Change when Y1 MAX*, the request for exter-

nally required signal is increased gradually until *Flow requirement MAX* is reached. When the flow temperature falls below *Change when Y1 MIN*, it is gradually increased until it is reduced to *Flow requirement MIN*.

A new operating phase starts with the same request for externally required signal that the

Example:

Flow requirement MIN = 60 °C

Flow requirement MAX = 90 °C

last phase finished with. When the system starts with system start-up mode, the temperature set under *Flow requirement MAX* is always requested, see example shown in Fig. 23.

Change when Y1 MIN = 10 %

Change when Y1 MAX = 90 %

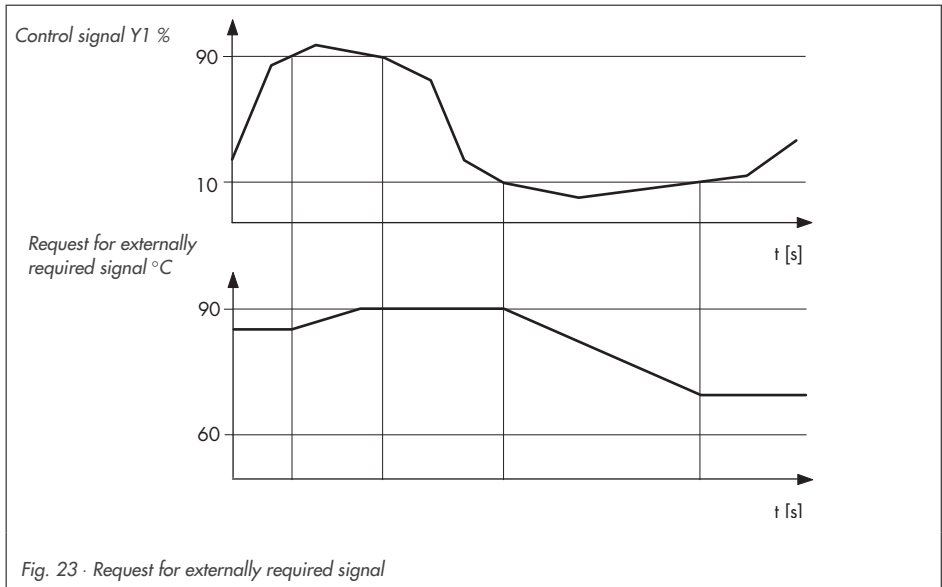

Fig. 23 · Request for externally required signal

5.4 Time functions

5.4.1 Summer deactivation

In summer, the heating coil is switched off when the date in a defined time period and the daily mean outdoor temperature exceed a set limit. The function is inactive outside of this time period.

Set the following parameters in PA1 for this function:

- ▶ Date when summer deactivation is enabled
- ▶ *Date when summer deactivation is disabled*
- ▶ *Outdoor mean temperature*

The daily mean outdoor temperature is measured every hour between 6:00 h and 22:00 h. You can view this temperature in the InF5 level, the current outdoor temperature, by holding the \times key pressed. This display also contains two other pieces of

information: the bar graph beneath the number 0 to 24 at the top of the LCD indicates the number of outdoor temperatures which have already been measured and used to result in the daily mean outdoor temperature currently shown. The figure "0" or "1" in front of the daily mean outdoor temperature on the display indicated whether the summer deactivation function is currently active (1) or inactive (2).

If the summer deactivation is active, the heating coil is switched off at 22:00 h for the next 24 hours, i.e. control signal Y1 = 0 % and pump output BA3 = OFF.

If the outdoor temperature falls below the set limit value, the heating coil control is enabled from 22:00 h for the next 24 hours, providing this is required according to the times-of-use or by the mode switch.

5.4.2 Summer time operation (PA)

The summer time operation function runs in all systems that have a mixed air chamber and outdoor temperature feedforward (Anl 2, Anl 4, Anl 8). The system is operated at outdoor temperatures that exceed a set limit value with a minimum outdoor air rate to avoid operation with 100 % outdoor air. Set the following parameter in PA2 for this function:

- ▶ *Summer time operation when the outdoor temperature is greater: outdoor temperature limit for summer time operation.*

Summer time operation can also be used in systems with cooling coil in which it is better to prevent operation with just outdoor air at high outdoor temperatures for reasons of energy efficiency.

5.4.3 Automatic summer time/winter time changeover (Co5Fb16)

If you activate the function block Co5Fb16, the ventilation controller automatically changes between summer time and winter time. The clock is set one hour forward on

the last Sunday in March from 2:00 h to 3:00 h and set back one hour on the last Sunday in October from 3:00 h to 2:00 h.

5.4.4 Public holidays and vacations (PA5)

The ventilation controller allows you to define 20 public holidays and 10 vacation periods. There are no preprogrammed vacation periods. Default settings for public holidays include 01.01, 01.05, 25.12 and 26.12. Enter the day and month to configure a public holiday. For vacation periods, enter the date (day and month) when the vacation is to start as well as the date when it should end. To enter a public holiday, set the display to ----- and enter a new date.

To delete a public holiday or vacation period, set the date shown to ----- on the display. This display appears between the dates 31.12. and 01.01.

To delete a vacation period, change the starting date to -----.

The ventilation controller uses the same times-of-use on public holidays as for Sunday. The ventilation system is switched off during a vacation period.

5.4.5 Time schedules (times-of-use) (PA4, PA5)

You can set separate times-of-use for the system in the parameter level PA5 and for fan speed 2 in PA4.

The time schedules can be set in a block for Monday to Sunday (1-7), for Monday to Friday (1-5), for Saturday and Sunday (6-7) or individually for each day (1, 2 ...7 = Mon, Tues, ... Sun). You can enter two times-of-use within a day over START times and STOP times. In this way, the system can be switched on, for example, early in the morning (first time-of-use) and then again in the afternoon (second time-of-use). If you need just one continuous time-of-use period, for example, the ventilation system is to run from the morning until the evening, set the same time for the start of the second time period

and the end of the first time period.

The default settings for the times-of-use of the ventilation system is daily between 07.00 h to 12.00 h and between 12.00 h and 22.00 h. The fan speed 2 is set to run daily between 10.00 h and 12.00 h and between 12.00 h and 15.00 h by default. Refer to page 26 ff. for detailed instructions on how to determine the times-of-use.

Note! When 1-7, 1-5 or 6-7 are selected, the times-of-use for the days selected are reset to the default settings. Therefore do not use this menu to check the programmed time schedules! To check time schedules, use just the menu for the individual days 1, 2, ..., 7 in the PA4 or PA5 level instead!

5.5 Control functions

5.5.1 System start-up mode

Usually, all ventilation systems go over to standard operation first after a start-up phase when a request for operation exists from deactivated state or from manual operation. The duration of the start-up is determined by the parameter *Pump advance running time for start-up* (PA1).

Two options exist to suppress the start-up mode partially or totally:

- ▶ Set the *Pump advance running time for start-up* to zero to deactivate it totally.
- ▶ When the outdoor temperature is fed forward, the mode is only used when the outdoor temperature is lower than the parameter *Start-up mode when the outdoor temperature is lower* (PA1)

If the ventilation system goes into operation according to the programmed times-of-use, then the start-up mode already starts to run before the time-of-use commences by the time period set in *Pump advance running time for start-up*. The fans are enabled exactly when the time-of-use starts.

If, however, the ventilation system is required to run by an external request for operation or by the mode switch, the fans are first enabled after a time delay set in *Pump advance running time for start-up*.

By enabling the heating coil circulation pump, the control signal Y1 for the heating coil is enabled at the same time:

- ▶ Without the temperature sensor F4 in the heating coil return air duct, the control

output Y1 runs either 100 % control signal or is set to the fixed value under *Control signal limit for Y1*. The *Control signal limit for Y1* only has any effect when the system start-up mode is active.

- ▶ With the temperature sensor F4 the value set under *Return air temperature maximum limit* or *Return air temperature maximum limit coordinate 1* is the set point for the warm-up of the heating coil during the start-up phase. Y1 varies corresponding to the system deviation.

All other control outputs – also the control output Y2 of an independent mixed air temperature control – usually do not run a control signal during the system start-up phase. The control output Y2 is enabled when the fans are enabled. Before the control output Y3 (cooling coil) can be enabled, the *Pump advance running time for start-up* must be run through a second time. In the supply air control circuit, the *Supply air temperature maximum limit* is set at first as the set point. Within five minutes, this value is led linearly to the current supply air set point.

Note: An active system start-up mode is indicated in the operating level by the symbol ☀ blinking on the display. During this operating phase, neither the master loop set points nor the slave loop set points can be shown on the display: ---- appears at the corresponding places as well as at the times-of-non-use on the display in the InF levels!

5.5.2 Summer compensation (PA5)

The function is basically available for all systems with a cooling coil: System code numbers Anl 1 and Anl 4 to Anl 9.

This summer compensation function lets the set points for supply air, exhaust air and room temperatures be shifted in a linear manner by means of two coordinates. For this purpose, the following parameters must be defined in PA5:

- ▶ *Summer compensation when the outdoor temperature is greater:* from this outdoor temperature onwards, the temperature set point is raised
- ▶ *Set point at an outdoor temperature of 32 °C* determines the gradient of the characteristic curve.

Example:

In an air-conditioning system, the exhaust air temperature set point is to be raised when the outdoor temperature is greater than 25 °C. At 32 °C, the exhaust air temperature set point should be 26 °C.

- ▶ *Exhaust air temperature set point* = 22 °C
- ▶ *Summer compensation when the outdoor temperature is greater = 25 °C*
- ▶ *Set point at an outdoor temperature of 32 °C* = 26 °C
- ▶ *Supply air temperature maximum limit* = 30 °C

5.5.3 Outdoor temperature-controlled supply air control

The functionality of the summer compensation, see section 5.5.2, can also be used for an outdoor temperature-controlled supply air temperature control, e.g. with system code number Anl 0. The parameter *Summer compensation when the outdoor temperature is greater* (PA5) determines from which outdoor

temperature the *Supply air temperature set point* is to be reduced. The parameter *Set point at an outdoor temperature of 32 °C* (PA5) determines also the gradient of the characteristic curve (see also Fig. 25).

Example:

A heating coil is to warm up the supply air to

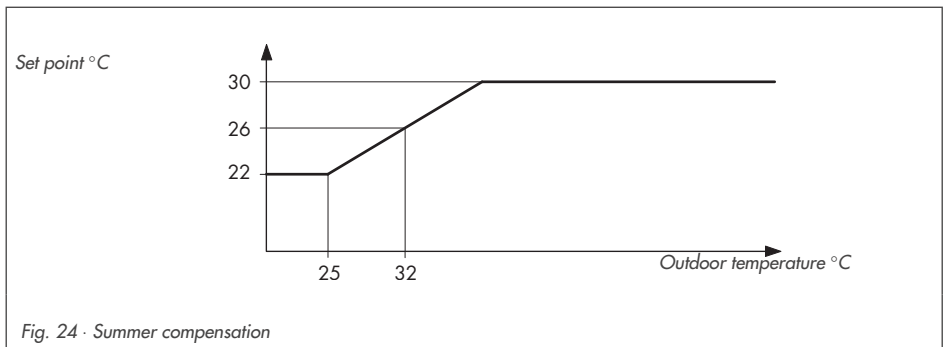

Fig. 24 · Summer compensation

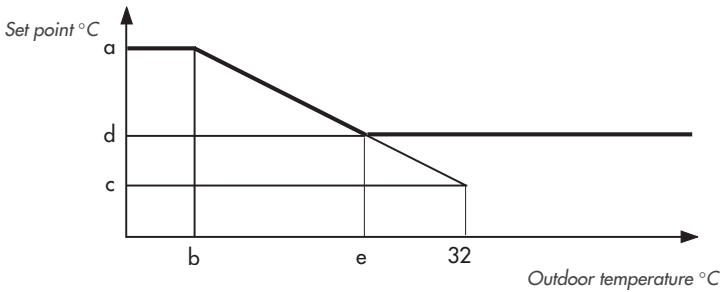

Fig. 25 · Outdoor temperature-controlled supply air control

35 °C at an outdoor temperature of –15 °C. The foot of the perpendicular is to be at 15 °C outdoor temperature / 20 °C supply air temperature.

- ▶ *Supply air temperature set point* = a = 35 °C
- ▶ *Summer compensation when the outdoor temperature is greater* = b = –15 °C
- ▶ *Set point at an outdoor temperature of 32 °C* = c
- ▶ *Supply air temperature minimum limit* = d = 20 °C
- ▶ *Foot for outdoor temperature* = e = 15 °C

▶ *Supply air temperature maximum limit* = 40 °C

The calculation of the temperature required for the parameter *Set point at an outdoor temperature of 32 °C* results in:

$$c = a - \frac{(a-d)}{(e-b)} \times (32^\circ\text{C} - b)$$

$$c = 35^\circ\text{C} - \frac{35^\circ\text{C} - 20^\circ\text{C}}{15^\circ\text{C} + 15^\circ\text{C}} \times (32^\circ\text{C} + 15^\circ\text{C})$$

$$c = 11.5^\circ\text{C}$$

5.5.4 Sustained room temperature (Co5Fb05)

If a room temperature sensor is connected, the *Sustained room temperature* (PA5) is monitored when the system is switched off. If the room temperature falls below this limit value, at first the system start-up mode is initiated for the time set under *Pump advance running time for start-up*. After this, if necessary, the supply air temperature is controlled constantly to the set point *Supply air tempera-*

ture maximum limit (PA5) (minus 1 K). When the room temperature has reached the *Sustained room temperature* (plus 2 K), the sustained room temperature function and usually the operation of the entire system is ended.

5.5.5 Night purge (Co5Fb17)

During the times-of-non-use, the night air can be used to cool the rooms under certain conditions: the fan operation is enabled and, if necessary, the mixed air chamber is reversed to 100 % outdoor air rate.

The night purge requires the room temperature and outdoor temperature. Additionally, activate the function block Co5Fb17 and set its following parameters:

- ▶ *Enable night purge* which indicates which room temperature must be exceeded before the night purge function can be requested.
- ▶ *Finish night purge* which indicates which room temperature must be reached before the night purge function is canceled.
- ▶ *Temperature difference to outdoor temperature* is the minimum temperature difference between room temperature and the outdoor temperature that needs to be reached before the night purge function can be requested.

The night purge is only enabled when the summer deactivation function is active (see section 5.4.1) and additionally, the following

conditions are met:

- ▶ Room temperature is greater than the room temperature limit *Enable night purge* and
- ▶ Temperature difference between room temperature and the outdoor temperature is greater than the value set under *Temperature difference to outdoor temperature*

The night purge can be set to start at 0:00 h at the earliest, 4:00 h at the latest – depending on the programmed system times-of-use. The controller must be programmed to start the night purge at the latest possible point in time (see example). It is limited to two hours at the maximum. If the room temperature falls below the room temperature limit value determined under *Finish night purge*, the night purge is ended early. Example:

- ▶ Start of time-of-use:
7:00 h => Night purge from 4:00 h
- ▶ Start of time-of-use:
5:00 h => Night purge from 3:00 h

5.5.6 Air quality control via the mixed air chamber (Co5Fb18...21, PA)

The air quality control via the mixed air chamber function is available in the systems code numbers An1 2, An1 4 and An1 8, provided an analog input for air quality L has been configured in the function block Co5Fb18...21. The control signal Y2 is formed from two control signals that exist internally and originate from the temperature control circuit and the air quality control circuit. If the measured air quality falls below

the value *Air quality set point* (PA4), the outdoor air rate determined until then just by the temperature control circuit is increased dependent on the control parameters K_P *Air quality control* and T_N *Air quality control* (PA4). Under optimal conditions, i.e. the *Air quality set point* is exceeded, the outdoor air rate can be gradually reduced by the PI control algorithm until it reaches *Minimum outdoor air rate*, provided the temperature con-

trol loop does not demand the opposite.

5.5.7 Supply air temperature limit (Co5Fb01, Co5Fb18 PA5)

The intention of the supply air temperature limit is to reduce the draft when supply air that is fairly cold is blown in. A supply air temperature sensor must be configured for this function: Co5F1= ON or in Co5F18 for the analog input AE1 F1. In addition, set the following parameters in the parameter level PA5:

- ▶ *Supply air temperature minimum limit*
- ▶ *Supply air temperature maximum limit.*

Both these parameters limit the temperature range within which the supply air temperature may vary.

If the supply air temperature is the control variable, i.e. for supply air temperature control or exhaust air or room temperature cascade control, the controller only permits set point shifts within this range.

If F1 or AE1 is just used as a limit input, i.e. for exhaust air or room temperature control, this deviation is included in the control when the supply air temperature exceeds or fall below the limit values, to counter any further drifting of the supply air temperature.

5.5.8 Return air temperature limit (Co5Fb04, PA1)

Activate the function block Co5Fb04 for the return air temperature limit and set the following parameters in the PA1 level:

- ▶ *Return air temperature minimum limit*
- ▶ *Return air temperature maximum limit*
- ▶ *Return air temperature limit factor.*

These parameters limit the temperature range within which the return air temperature may vary in standard operation.

If the return air temperature moves towards these limits, the set point is corrected (for the cascade control, the set point of the exhaust air or room temperature). In the range *Return air temperature minimum limit*, the set point is directly raised by the amount x multiplied by the *Return air temperature limit factor* for every amount x that the return air temperature falls below. In the range *Return air temperature maximum limit*, the set point is

directly lowered by the amount x multiplied by the *Return air temperature limit factor* for every amount x that the return air temperature exceeds.

The supply air temperature limit function has priority!

Example:

- ▶ *Return air temperature minimum limit* = 20 °C
- ▶ *Return air temperature limit factor* = 2.0
- ▶ Current return air temp. = 17 °C
- ▶ *Supply air temperature set point* = 30 °C
- ▶ *Supply air temperature maximum limit* = 40 °C
- ▶ Supply air temperature set point_{calculated} = 36 °C

5.5.9 Variable return air temperature maximum limit (PA1)

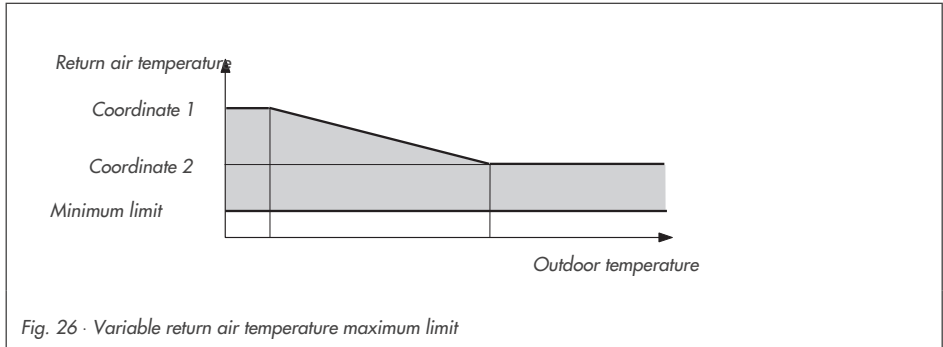

Fig. 26 · Variable return air temperature maximum limit

If an outdoor temperature sensor and a return air temperature sensor exist, it is possible to vary return air temperature limit as shown in Fig. 26. Set the two coordinates for the following parameters in PA1 for the upper variable limit of the return air temperature:

- ▶ *Return air temperature maximum limit coordinate 1,*
- ▶ *Outdoor temperature coordinate 1,*
- ▶ *Return air temperature maximum limit coordinate 2,*
- ▶ *Outdoor temperature coordinate 2.*

Additionally, set the parameters:

- ▶ *Return air temperature minimum limit and*
- ▶ *Return air temperature limit factor*

The gray shaded area in Fig. 26 indicates the permissible return air temperatures. If the *Return air temperature maximum limit* is exceeded by the amount x , the set point (for cascade control, the set point of the exhaust air or room temperature) is reduced by the amount x multiplied with the *Return air temperature limit factor*.

5.5.10 Supply air humidity limit (Co5Fb06, Fb19; PA5)

A humidity sensor must be configured for supply air humidity control. Activate the function block Co5Fb06 or Co5Fb19 and select AE2 F6. Set the following parameters in the PA5 level:

- ▶ *Supply air humidity minimum limit*
- ▶ *Supply air humidity maximum limit*

For exhaust air or room humidity control, these two parameters restrict the humidity

range within which the supply air humidity may vary. If it leaves this range, the deviation is included in the system deviation to prevent any further drifting of the supply air humidity.

The main purpose of the supply air humidity maximum limit is to prevent condensation forming in the supply air duct.

5.6 Controller reaction when faults occur

5.6.1 Sensor failure and malfunctions

Interruptions or short circuits in the sensor wiring as well as other malfunctions are indicated by the symbol  that blinks on the display. In the InF levels, ---- appears on the display instead of a measured value when a sensor has failed.

After a sensor for a controlled variable has failed, all the control outputs of the controller run a 0 % control signal. The binary outputs for pumps and fans maintain their operating states. If the frost protection function becomes

active, the fans are switched off by this function.

When the sensor for exhaust air temperature or humidity or for room temperature or humidity required for the master loop fails, the *Supply air temperature maximum limit* or *Supply air humidity maximum limit* is used by the controller.

When any of the other sensors fail, the controller continues to function as if this sensor is not configured.

5.6.2 Setting default values

Deactivate the function block Co5Fb23 to reset in the parameter level (!) all parameters to their default values by pressing the  reset key. Refer to Appendix B to find a list of

the default settings.

The controller is ready for operation using its default values. Just the current date and time need to be set.

5.7 Protective functions

5.7.1 Frost protection

System frost protection (Co5Fb15, BE11)

This function is used to protect the heating coil from being damaged by frost. Activate the function with Co5Fb15. Depending on the binary input BE11, the system runs in standard mode or the frost protection function is run. BE11 must be ON for standard mode.

If BE11 input makes contact, the frost protection function starts: the fans are switched off and the circulation pump of the heating coil

is switched on; a 100 % signal is issued at the control output of the heating coil Y1. When the frost protection function is active, **STOP** and the symbol ❄️ blink on the display.

The standard mode is only restarted when the binary input BE11 is reactivated. The frost protection function is also active in manual operation.

Frost protection HRU (Co5Fb06, PA2)

The function "Frost protection HRU" is set when the sensor F6 is activated, e.g. Co5Fb06 = ON. It makes sure when the system is running that the heat recovery equipment, e.g. circuit connected heat exchanger or rotating heat-moisture recovery, does not freeze on the outside. If the HRU return air temperature falls below or, alternatively, the outgoing air temperature measured directly at the heat recovery unit falls below the parameter *Heat recovery minimum temperature*, the frost protection function is started: the heat recovery unit is released from the

sequential operation. The limit value programmed in PA2 under *Heat recovery minimum temperature* is used as the set point for an independent temperature control of this unit to make sure that further cooling off of the outgoing air/return air does not occur. The frost protection HRU remains active until the control signal Y2 for heat recovery has risen to a value of 95 %; directly after that, the sequential operation is reactivated. When the frost protection mode for HRU is active, the symbol ❄️ blinks on the display.

Stand-by monitoring

The outdoor temperature is required for this function. The circulation pump of the heating coil is activated whenever the outdoor temperature falls below the value *Pump ON when*

the outdoor temperature is lower (PA1). If the stand-by monitoring is active, the ❄️ symbol appears on the display of the controller in the operating level.

Stand-by control

If the outdoor temperature sensor and a return air temperature sensor (F4) exist, the value *Return air temperature minimum limit* (PA1) is controlled in the heating coil for the frost protection in addition to the stand-by

monitoring function. An active stand-by control is indicated in the operating level of the controller by the ❄️ symbol appearing on the display.

5.7.2 Locking settings (Co5Fb23)

Activate this function block to mask all Co levels and all the parameters in the PA levels except for time and date settings, the night and day set points for supply air, exhaust air and room temperatures as well as the set points of the slave loop, times-of-use, vacations and public holidays. After accessing the

Co5 level, **Fb23** appears on the display. Only after Co5Fb23 has been deactivated which also requires entry of the key code, all functions and parameters are accessible again.

5.7.3 Forced operation of the pumps

The circulation pump of the heating coil as well as the heat recovery unit's pump are automatically started by the controller at least

once every day to prevent them from jamming.

6 LON communication (Co7, PA7, Co5 Fb03)

The TROVIS 5177 Ventilation Controller can be linked together with other controllers from the TROVIS 5100 series in a specific SAMSON LON network. In this way, two outdoor temperatures, the flow temperature for externally required signal and the time can be exchanged among the connected controllers. A special communication tool is not necessary. Just the LON communication must be activated, an address allocated to each controller in the LON network as well as a definition about which controller sends which

value to the LON bus. It is possible to define that a controller send all values or each different value is sent from a separate controller. Data are transmitted every 4 minutes over the LON bus, except when the temperature values changes significantly ($\Delta t_A > 0.5 \text{ K}$; $\Delta t_{VL} > 2 \text{ K}$) which are sent immediately. The values from the LON bus remain valid in the controllers for a maximum of 10 minutes before error routines become active. If the controller issuing the time fails, the time runs on locally in all the other controllers.

6.1 Configuring the LON interface

1. Activate the function block Fb00 in Co7 to switch on LON communication.
2. Allocate a node address in PA7.
A subnet is automatically assigned to each type of controller (e.g. 5174), see table below. Assign each controller a node address (1 to 20) in the parameter level PA7, making sure a node address is only assigned once within a subnet. But, for example, it would be permissible to assign the node address 9 for a TROVIS 5174 Controller as well as for a TROVIS 5179 Controller since they belong to different subnets.

Controller type	Subnet	Node address
5174	4	1 to 20
5177	7	1 to 20
5179	9	1 to 20
Primary controller	1	1

You can optionally determine the following functions in Co7:

- ▶ You can define a controller to function as the primary controller in a control system, this is, however, not absolutely necessary. The primary controller receives the request for the externally required signal from all the other controllers and controls the primary flow temperature correspondingly. Activate Co7 Fb01 in a controller to turn it into the primary controller.
- ▶ Activate Co7 Fb02 to send the time. This function block, however, may only be set in one controller to ensure all the controllers function with the same time. If the time is sent over LON, all the other devices in a system automatically function with this time.
- ▶ Activate Co7 Fb03 to send the outdoor temperature Lon1 and activate Co7 Fb04 for outdoor temperature Lon2. After activating these function blocks, the number of the terminal to which the outdoor sen-

sensor is connected must be entered. This does not necessarily have to be the outdoor sensor AF, it can also be a sensor connection of any other free terminal.

- ▶ In each controller in the system, you must set which outdoor temperature (Lon-1, Lon-2 or local) is to be used in the controller for the control. The function block

Co5 Fb02 determines which outdoor temperature in the controller is to be used.

When Fb02 = ON, the local outdoor temperature at sensor F3 or measured at an analog input is used. Deactivate Fb02 to choose between: --- (no outdoor temperature), Lon1 or Lon2.

7 Serial interface (Co9)

7.1 Interface versions

The ventilation controller is equipped with a RS-232 C serial interface to allow it to communicate with a control station. A complete control system can be set up using an appropriate software for visualization and communication. All functions and parameters of the serial interface are set in the Co9 level and PA9 level.

Two types of operation with a modem for a dedicated line or a dial-up line are possible over the RS 232 C serial interface.

- ▶ Operation with a dial-up modem
The controller only communicates with the control system when faults occur. The controller works autonomously. Fault alarms can be sent directly to the control station or over SMS text messaging to a mobile phone or over fax.
- ▶ Operation with a dedicated line
The controller and control system communicate with one another constantly over the bus. Direct connection of a ventilation controller over RS-232 to a PC is also conceivable.

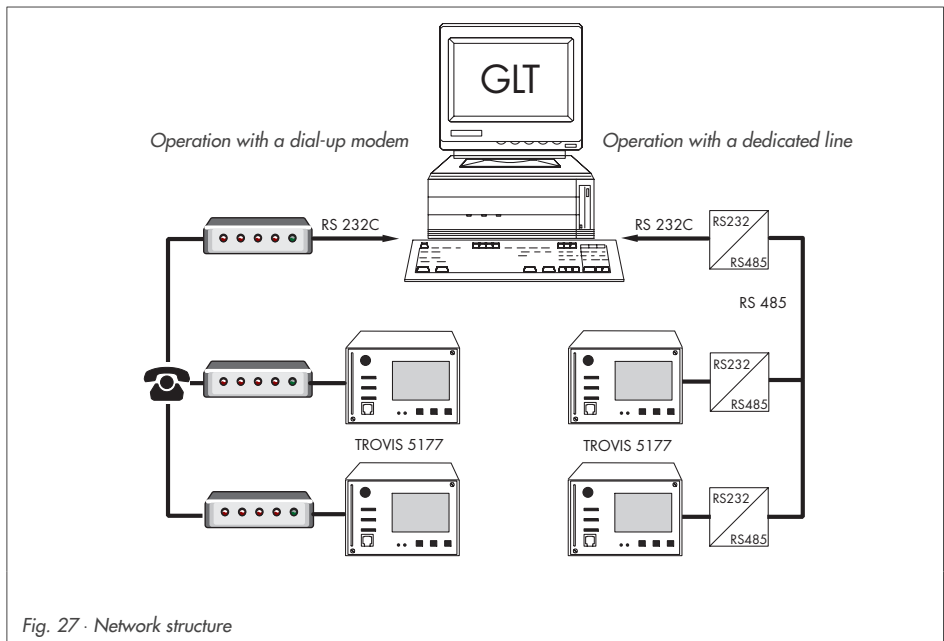

Fig. 27 · Network structure

7.2 Operation with a dial-up modem

7.2.1 Configuring the controller interface

Carry out the following instructions, depending on whether the ventilation controller is to send alarms when faults occur over a dial-up

modem to a control station, or to a mobile phone or a fax:

Error message to a control station

Define the following function blocks in C09:

1. Fb06 and Fb10 OFF
2. Fb00 and Fb01 ON
3. Activate or deactivate Fb02 and Fb03

4. Set the parameters in PA9 described in section 7.2.2.

Error message to a mobile phone

The ventilation controller can send an error message over text messaging (SMS) to a mobile phone. The device uses for this the TAP protocol which is supported in Germany by the mobile telephone network D1 and EPlus. To do this, enter the access number and the complete mobile telephone number in the PA9 level. The D1 access number is 01712092522 and following this, the mobile phone number starting with 49171...

For E Plus, the access number is 01770610000 and following this, the mobile phone number starting with 49177...

Define the following function blocks in C09:

1. Fb00, Fb01, Fb10 OFF
2. Fb06 ON
3. Fb07 according to your own requirements
4. Enter the access number (ZUGno) and mobile phone number (HAndY) in PA9.

Error message to a fax

Define the following function blocks in C09:

1. Fb00, Fb01, Fb06 OFF
2. Fb10 ON

Enter the telephone number of the fax machine (teLno) in PA9. Optionally, set a station identification (St Id).

7.2.2 Parameters for operation with dial-up modem (PA9)

Note: The specified initialization settings must be set when the controller is used with a dial-up modem. It cannot be guaranteed that data are transferred after the initialization settings have been adjusted. Due to the broad range of modems available on the market and the different terms used for commands, refer to the operating manual of the modem used for further settings. When operating with a dial-up modem, data cannot be written to the controller at first after connection has been established. It is first possible after the correct key number has been sent to holding register 70.

The following settings are often used in numerous modems:

- ▶ E0 (Echo off)
- ▶ X3 (Do not wait for dial tone)
- ▶ V1 (Result code in text format)
- ▶ \V0 (Standard connect messages)

- ▶ Q0 (Result codes on)
- ▶ %C0 (Data compression off)
- ▶ \N1 (Buffer switched off)
- ▶ %B9600 (Baud rate 9600)

The following parameters are set in PA9 level. Refer to Appendix B for a list of value ranges and default settings.

Station number

The stations number is the controller's address. It can only be allocated once in a

system (network) and can be set in PA9.

Baud rate (*BAUD*)

The baud rate indicates the transmission rate and can be set in the parameter level PA9. Within a bus system, the transmission rate is

the same as the transfer rate between the control station and the controller. The baud rate within the system must always be the same.

Cyclic initialization (*I*)

This parameter defines the period of time for a cyclical issue of the initialization command "ATZ". When the "ATZ" command is issued, the profile 0 is copied to the active profile in the modem provided the modem parameters have been set and saved in profile 0 using a terminal program that came with the modem.

The command is not issued during dial-up or when connected.
An example of initialization of a modem with a terminal program:

- ▶ AT&F {terminal input: set modem to default settings}
- ▶ OK {modem feedback}

- ▶ AT E0 S0=1 {terminal input: data echo off, answer after first ring and establish communication}

Modem dialing interval (P)

This parameter indicates the time interval that must be kept between two calls to avoid overloading the telephone network. It is usually between 3 to 5 minutes.

Modem timeout (t)

Modem timeout is the time period after which a connection to the control station (GLT) is terminated after there is no response to the station address.

Number of dialing attempts to control station (C)

The parameter C indicates how many attempts are to be made to dial the control station when the control station line is busy without resetting the function to trigger a call by the control system. After the specified number of redialing attempts have failed, the controller uses the alternative phone number. The function to trigger a call is reset by the control system by polling the status register (FSR).

Telephone number of the control station (tELno)

Enter here the telephone number of the control station's modem or fax, if necessary, with dialing code. The telephone number may have 23 characters at the maximum. "-" indicates the end of the string. Enter numbers with arrow keys and confirm the number with the enter key. Enter short pauses of 1 second (e.g. between dialing code and the telephone number) using "P" which appears on the display when scrolling with arrow key after "9".
Example: Telephone number 069-654321
--> Enter 0 6 9 P 6 5 4 3 2 1

Telephone number of the alternative recipient (rESno)

Enter the telephone number of an alternative recipient which is to be dialed when the line of the control station is busy. Enter in the same manner as the control station number.

Station identification

The station identification can be any number.

7.3 Status register

The 16-bit holding register HR 60 is an error status register which contains controller errors. The control station is automatically

dialled over the dial-up modem as soon as the status of this holding register changes. HR 60 is transferred in text format.

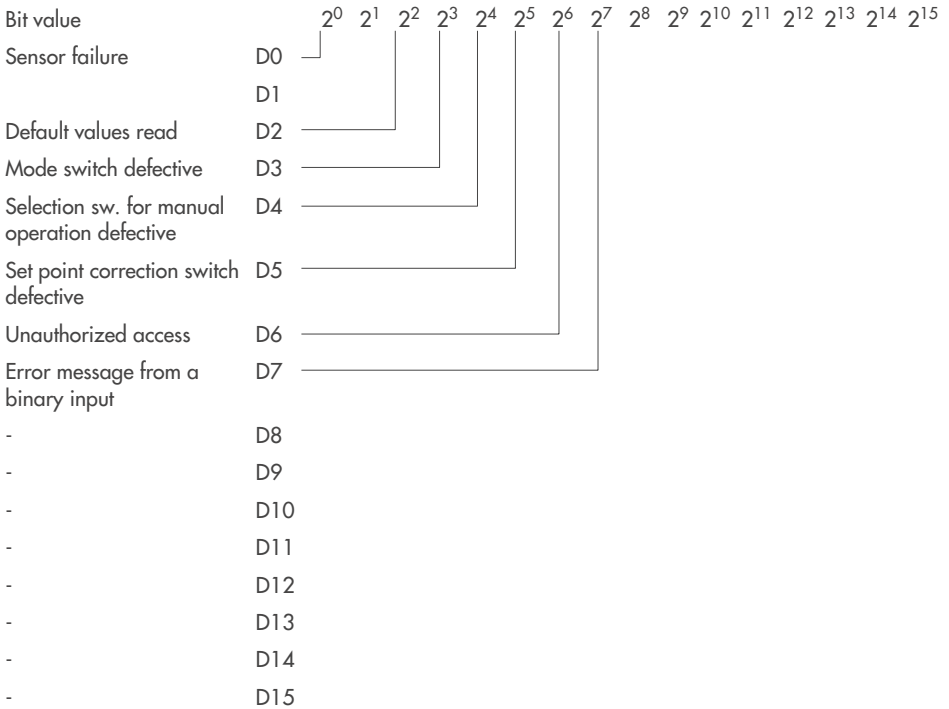

7.4 Operation with a dedicated line (bus operation)

7.4.1 Bus connection to RS-485 interface

A converter cable (SAMSON 1400-7308) is required to integrate the ventilation converter in a four-wire bus. It converts the RS-232 signal from the controller into a RS-485 signal for the bus as well as vice versa.

Fig. 27 shows the bus topology. The bus line connects all the control devices through an open ring. The four-wire bus is connected to the control station at the end of bus line using

a RS 485/RS 232 converter (e.g. TROVIS 5484).

The maximum cable length is 1,200 m. In this segment, up to 32 devices may be connected. If you wish to use more devices or bridge greater distances, make sure repeaters (e.g. TROVIS 5482) are installed to replicate the signal. On the whole, max. 246 participants can be connected in line.

7.4.2 Configuring the interface

The following settings must be made before the controller is ready for bus operation:

1. Activate the function block Fb00 in Co9.

2. Deactivate all other function blocks.

3. Set the parameters for station number and baud rate in PA9.

8 Memory module

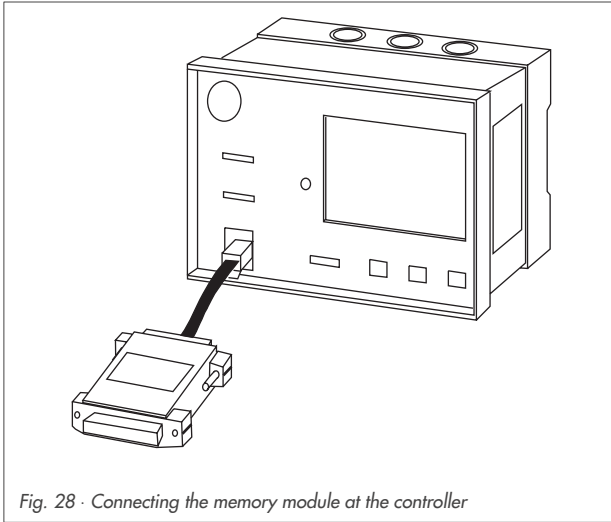

Fig. 28 · Connecting the memory module at the controller

The memory module allows configuration data and parameter settings to be transferred from the controller to the PC and vice versa. Likewise, all the settings of one controller can be copied and transferred to another controller.

The memory module has a sub-D 25-pin female connector to connect it to a PC and a modular jack to connect the memory module to the connector.



Connect the memory module at the front panel of the controller only! The rear connection is only suitable for communication with the control station. Never connect the memory module to a controller and a PC simultaneously!

8.1 Data transfer between controller and memory module

Proceed as follows to transfer data between the ventilation controller and the memory module:

1. Insert the RJ12 jack of the memory module into the controller.
SP-77 appears on the display. This combination allows data to be transferred from the memory module (SP) to the controller (77).
2. For data transfer in the other direction,

i.e. from the controller to the memory module, press the arrow key until **77-SP** appears on the display.

3. Press the enter key. The bars run across the top section of the display to indicate that data transmission from the controller to the memory module is in progress.
4. When the bars stop running across the display, carefully remove the RJ12 jack.

9 Installation

The controller consists of the controller housing with the electronics and the rear panel of the controller with the terminals. It is suitable

for panel, wall and top hat rail mounting (Fig. 29).

Panel mounting

1. Remove both screws (1).
2. Pull apart the controller housing and the rear panel.
3. Make a cut-out of $138^{+1} \times 92^{+0.8}$ mm (w x h) in the control panel.
4. Insert the controller housing through the panel cut-out.
5. Insert a mounting clamp (2) each at the top and the bottom. Screw the threaded rod towards the panel, so that the housing is clamped against the control panel.
6. Install the electrical connections at the rear of the housing as described in section 9.
7. Fit on the controller housing.
8. Fasten both screws (1).

Wall mounting

1. Remove both screws (1).
2. Pull apart the controller housing and the rear panel.
3. If necessary, bore holes with the specified dimensions in the appropriate places. Fasten the rear of the housing with four screws.
4. Install the electrical connections at the back of the housing as described in section 10.
5. Fit on the controller housing.
6. Fasten both screws (1).

Top hat rail mounting

1. Fit the spring-loaded hook (4) at the bottom of the top hat rail (3).
2. Slightly push the controller upwards and pull the upper hooks (5) over the top hat rail.

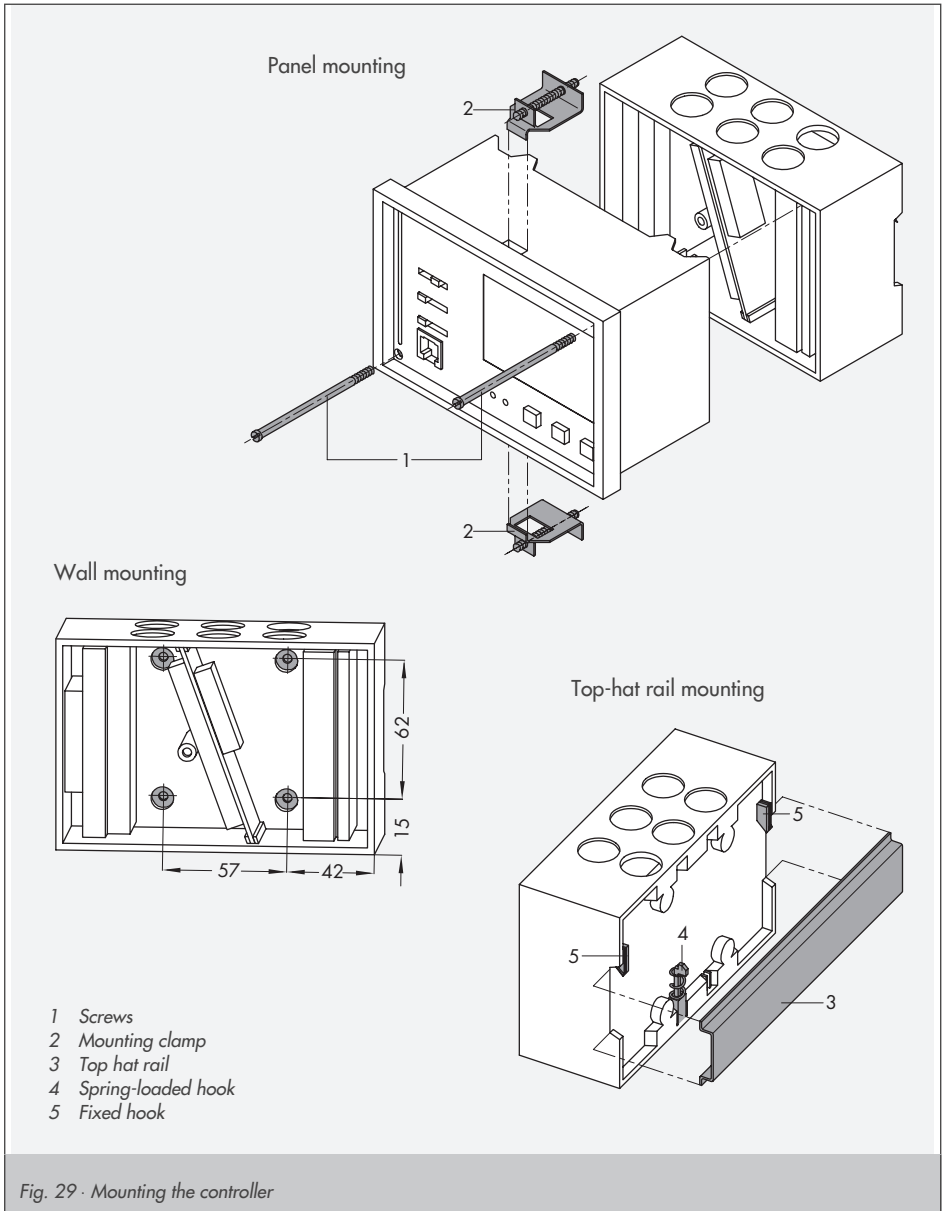

Fig. 29 · Mounting the controller

10 Electrical connection



Caution!

For the wiring and connection of the controller, you are required to observe the regulations of the Association of German Electrical Engineers (VDE) and your local power supplier. For this reason, this type of work must be carried out by a specialist.

Caution: The 0 to 10-V inputs of the controller are not DC-isolated from the control outputs. If actuators and active sensors are used which are supplied from the same operating voltage source, either all the actuators or all the sensors must be DC-isolated. **If these instructions are not followed, the controller may be destroyed.**

Notes concerning the electric wiring

- ▶ Use separate cables for the 230 V supply lines and the signal lines! To improve the noise immunity, keep a minimum distance of 10 cm between these cables. This distance also applies to the cables inside the control cabinet.
- ▶ Use separate cables for the digital signals (bus lines) and the analog signals (sensor cables, analog outputs).
- ▶ We recommend that shielded cables be used for analog signal lines in systems with a high level of electromagnetic noise. Ground the shield at the control cabinet inlet or outlet, using a large surface contact. Connect the central grounding point using a cable with $\geq 10 \text{ mm}^2$ on the shortest route to the PE grounding conductor.
- ▶ Equip the inductances in the control cabinet, e.g. contactor coils, with suitable interference suppressors (RC elements).
- ▶ Control cabinet elements with high field strengths, e.g. transformers or frequency converters, should be shielded by means of separators that have good chassis ground.

Surge protection measures

- ▶ If signal lines are routed outside of buildings or over long distances, you are required to provide appropriate surge protection measures. These are imperative when bus lines are used.
- ▶ The shield of signal lines that are routed outside buildings must have current carrying capacity and must be grounded on both sides.
- ▶ The surge diverters must be installed at the control cabinet inlet.

Connecting the controller

Connect the controller as shown in Fig. 30. It is important to observe the system code number and the configuration. Open the casing to connect the wiring as described in sec-

tion 9. Make holes to feed through cables at the marked locations on the top, bottom or back of the rear casing. Insert the enclosed grommets.

Connecting sensors

Connect cables with a minimum cross-section of $2 \times 0.5 \text{ mm}^2$ to the terminal strip of the

casing rear panel.

Connecting actuators and pumps

Guide cables suitable for damp locations with a minimum cross-section of 1.5 mm^2 to the terminal strip of the controller according

to the wiring plan.

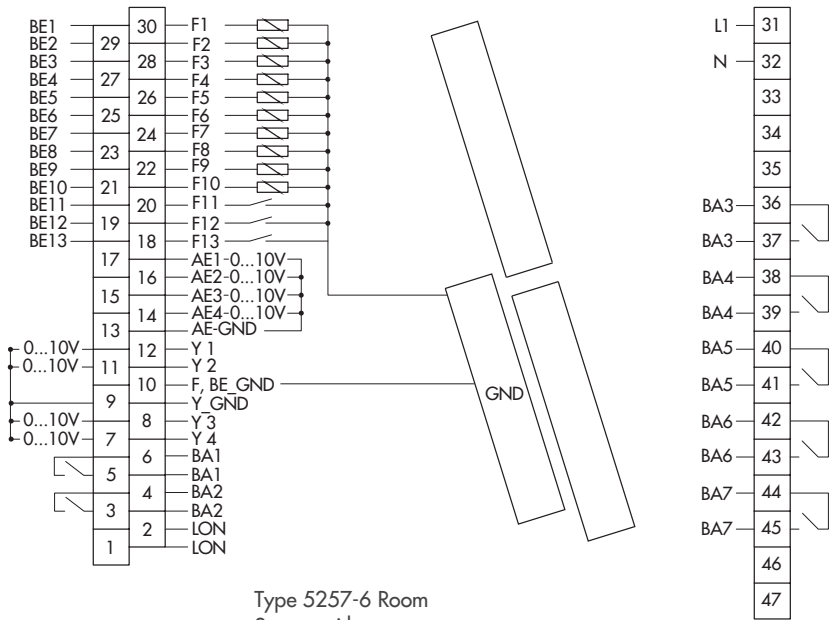

Type 5257-6 Room Sensor with remote control

TROVIS 5177

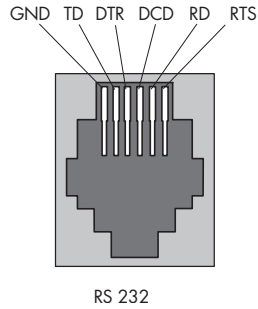
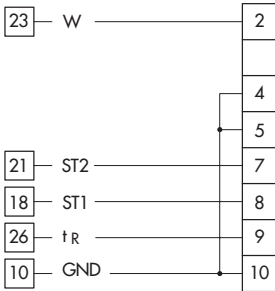

- AA Analog output
- AE Analog input
- BA Binary output
- BE Binary input
- F Sensor or potentiometer input
- GND Ground

- ST1 Fan speed 1
- ST2 Fan speed 2
- t_R Room temperature
- W Temperature set point
- Y Control output

Fig. 30 · Electrical connection

11 Technical data

Inputs	<p>10 configurable inputs for Pt 100 and PTC sensors, Pt 100 and Pt 1000 sensors or binary messages (e.g. system ON, fans speed 2, fan operation feedback and frost protection)</p> <p>3 inputs F8, F9 and F10 just for potentiometers 1000 to 2000 Ω or binary messages</p> <p>4 inputs for 0 to 10 V ($R_i = 18k\Omega$) for connecting active temperature, humidity and air quality sensors, (temperature measuring range adjustable)</p>
<p>Outputs</p> <p>Analog outputs</p> <p>Binary outputs</p>	<p>4 continuous-action outputs 0 to 10 V, load $>5 k\Omega$</p> <p>1 for fault indication, floating, max. 50 V, 100 mA</p> <p>5 for pumps, fans and chiller, floating,</p> <p>Loading capacity: max. 230 V AC, 3 A $\cos \gamma = 0.6$; min. 230 V AC, 10 mA, 24 V AC, 50 mA</p>
Interfaces	<p>RS-232 interface for connection to a modem</p> <p>LON (free topology)</p>
Operating voltage	230 V (+10 %, -15 %), power 8 VA
Ambient temperature	<p>0 to 40 °C (operation)</p> <p>-20 to 60 °C (transportation and storage)</p>
Degree of protection	IP 40 corresponding to IEC 529
Class of protection	II corresponding to VDE 0106
Degree of contamination	2 corresponding to VDE 0110
Overvoltage category	II corresponding to VDE 0110
Humidity rating	F corresponding to VDE 40040
Noise immunity	Corresponding to EN 50082 Part 1
Noise emission	Corresponding to EN 50081 Part 1
Weight	Approx. 0.6 kg

Appendix A Lists of function blocks

Appendix A.1 Configuration level Co1 for heating coil

Fb	Function	WE	Anl.	Comments
01	Request for externally required signal see p. 66	OFF	0...9	ON = Request for externally required signal; parameters: Flow requirement (MIN): 0 to 120 [90] °C, Flow requirement (MAX): 0 to 120 [90] °C, Change when Y1 (MIN): 0 to 100 [10] °C, Change when Y1 (MAX): 0 to 100 [90] °C (interlockable)
12	On/off output for heating coil at BA7 see p. 59	OFF	0...9	ON: BA7 activated/deactivated depending on Y1; parameters: Activating value (START): 0 to 100 [30] %, Deactivating value (STOP): 0 to 100 [10] % (interlockable); only when Co1 Fb13 = OFF
13	Three-step output for heating coil at BA6, BA7 see p. 60	OFF	0	ON: BA6 Operating action CLOSING, BA7 Operating action OPENING; parameters: Valve running time TY: 12, 30, 45, 240 [90] sec only when Co1 Fb12 = OFF
21	Operating action of heating coil	OFF	0...6, 8, 9	ON: 0 % = 10 V, 100 % = 0 V

Appendix A.2 Configuration level Co2 for heat recovery

Fb	Function	WE	Anl.	Comments
21	Operating action of heat recovery	OFF	2...5, 8, 9	ON: 0 % = 10 V, 100 % = 0 V

Appendix A.3 Configuration level Co3 for cooling coil

Fb	Function	WE	Anl.	Comments
01	Condensation detection see p. 55	OFF	1, 4, 5, 6*, 7, 8*, 9*	ON = activated, select BE10/BE7, StEIG/FALL StEIG: make contact, FALL: break contact Note: Can only be changed after entering key code! See p. 30 * humidifying only

Fb	Function	WE	Anl.	Comments
12	Enabling the cold storage see p. 58	OFF	1, 4 ... 9	OFF = Cold storage enabled, parameter: Enabling the cold storage at outdoor temperature (START): 0 to 30 [18] °C
	BA6 dependent on Y3 see p. 58 Chiller in parallel operation see p. 61		1, 4 ... 9; for 7 SEQ only	ON = Select: SEQUential operation or PARallel operation For SEQ parameter: BA6 dependent on Y3 Activating value (START): 0 to 100 [30] %; Deactivation value (STOP): 0 to 100 [10] % (interlockable) For PAR parameter: Minimum activated time (START MIN): 0, 60 to 3600 [600] sec; Minimum deactivated time (STOP MIN): 0, 60 to 3600 [600] sec; Deactivate cooling when Y1 > (STOP): 0 to 100 [50] %
21	Operating action of cooling coil	OFF	1, 4 ... 9	ON: 0 % = 10 V, 100 % = 0 V

Appendix A.4 Configuration level Co4

Fb	Function	WE	Anl.	Comments
01	Fan operation feed-back at BE12 see p. 53	OFF	0...9	ON: Parameter: Delay time (START): 0 to 180 [180] sec
02	2-speed fans over BA4/BA5 see p.	OFF	0...9	ON = Select: Speed 2: BA4 = BA5 = ON or BA4 = OFF, BA5 = ON Parameter: Delay time: 0 to 60 [0] sec
03	External demand for fan speed 2 see p. 54	OFF	0...9	ON (only when Fb02 = ON) BE10 or BE7 = ON switches on speed 2; Select: BE10 or BE7
04	Air volume control over Y4 see p. 66	OFF	0...7	ON (only when analog input for air quality L in Co5 Fb18, Fb19, Fb20 or Fb21), Parameters: Minimum air volume flow (MIN): 0 to 100 [25] %; Factor of change (K _p): 0.0 to 10.0 [0.0] (for cascade control only)

Fb	Function	WE	Anl.	Comments
20	Operating action L	OFF	0...9	ON: 0 V = display L 100.0, 10 V = display L 0.0
21	Operating action of humidifier	OFF	6, 8, 9	ON: 0 % = 10 V, 100 % = 0 V
22	Operating action of fans	OFF	0...9	ON: 0 % = 10 V, 100 % = 0 V

Appendix A.5 Configuration level Co5 of functions affecting all systems

Fb	Function	WE	Anl.	Comments
01	F1, supply air temperature		0...9	Active for supply air, exhaust air or room air cascade controls, otherwise depending on configuration; Inactive when F1 for AE1 is activated in Co5 Fb18
02	F2, exhaust air temperature		0...9	Active for exhaust air control and exhaust air cascade control, otherwise depending on configuration; Inactive when F2 for AE3 is activated in Co5 Fb20
03	F3, outdoor temperature		0...9	Active = outdoor temperature at F3 Inactive when an analog input for F3 is activated in Co5 Fb18...21 OFF and Co7 Fb00=ON, select: Lon1/Lon2/--- Lon1: outdoor temperature value 1 Lon2: outdoor temperature value 2 ---: no outdoor temperature
04	F4, return air temperature of heating coil		0...6, 8, 9	ON = activated
05	F5, room temperature		0...9	Active for room control and room cascade control, otherwise depending on configuration; Inactive when F5 for AE3 is activated in Co5 Fb20
06	F6, return air temperature HRU		3, 5	ON = activated
	F6, supply air humidity		6, 8, 9	Active for supply air, exhaust air or room cascade controls, otherwise depending on circuit; Inactive when F6 for AE2 is activated in Fb19

Fb	Function	WE	Anl.	Comments
07	F7, mixed air or outgoing air temperature		2, 4	ON = Select mixed air sensor/SEQ mixed air sensor: mixed air temperature control SEQ: sequential operation with outgoing air temp.; OFF = Select SEQ/AT SEQ: sequential operation with exhaust air temperature (only when Co5 Fb2 = ON) AT: outdoor temperature-controlled mixed air chamber operation
	F7, exhaust air humidity or room humidity		6, 8, 9	ON with exhaust air control/cascade control, room control/cascade control; otherwise depending on configuration; OFF when F7 for AE4 is activated in Co5 Fb21
08	F8, potentiometer for temperature set point	OFF	0...9	ON = Set point adjustable by ± 5 K (with 1000 to 2000 Ω)
09	F9, potentiometer for outdoor air rate	OFF	2, 4	ON = Outdoor air rate adjustable between <i>Minimum outdoor air rate</i> (PA2) and 100 % (1000 to 2000 Ω)
	F9, potentiometer for humidity set point	OFF	6, 8, 9	ON = Set point adjustable by ± 20 % rH (1000 to 2000 Ω)
13	External demand for operation with BE13 see p. 54	OFF	0...9	ON and mode switch switched to ☺ BE13 = ON: Ventilation on, with system-start mode, if necessary BE13 = OFF: Operation acc. to times-of-use ON and mode switch switched to ☾ BE13 = ON: Operation acc. to times-of-use BE13 = OFF: Ventilation out of operation
15	System frost protection with BE11 see p. 77	OFF	0...9	ON = Standard mode or frost protection operation dependent on BE11 BE11 = OFF: Frost protection operation BE11 = ON: Standard mode
16	Automatic summer time/winter time changeover see p. 69	ON	0...9	OFF = No automatic summer time/winter time changeover

Fb	Function	WE	Anl.	Comments
17	Night purge see p. 73	OFF	0...9	ON = Only with outdoor and room temperature, parameters: Enable night purge (START): 10 to 50 [24] °C Finish night purge (STOP): 10 to 50 [18] °C (interlockable), Temperature difference to outdoor temperature: 0 to 50 [5] °C
18	Assignment of analog input AE1 0 to 10 V see p. 54	OFF	0...9	ON: Determine measured variable and measuring range Select measured variable: Supply air temperature F1 (AE1F1) Exhaust air temperature F2 (AE3F2) Outdoor temperature F3 (e.g. AE2 F3) Room temperature F5 (AE3F5) Supply air humidity F6 (AE2F6) Exhaust air or room humidity F7 (AE4F7) Air quality L (e.g. AE4L) Select measuring range: for temperatures F1, F2, F3, F5 Lower meas. range value MIN -40 to 0 [-40] °C Upper meas. range value MAX 0 to +70 [+50] °C for humidity F6, F7: Lower meas. range value MIN -10 to +10 [0] % rH Upper meas. range v. MAX 90 to 110 [100] % rH for air quality L (0 to 10 V = 0 to 100 L) (observe Co4 Fb20!) Lower measuring range value MIN -10 to +10 [0] L Upper meas. range value MAX 90 to 110 [100] L! Note: Temperature measured variable can only be connected to analog inputs as an alternative if they are marked in the system schematics. Locking prevents assigning the input twice.
19	Assignment of analog input AE2 0 to 10 V see p. 54	OFF	0...9	
20	Assignment of analog input AE3 0 to 10 V see p. 54	OFF	0...9	
21	Assignment of analog input AE4 0 to 10 V see p. 54	OFF	0...9	
22	Assignment of analog input AE5 0 to 10 V see p. 54	OFF	0...9	
23	Locking settings see p. 78	OFF	0...9	

Appendix A.6 Configuration level Co6 for sensor initialization

Fb	Function	WE	Anl.	Comments
00	Sensor selection <i>see p. 53</i>	OFF	0...9	OFF = Pt 100 and PTC sensors, also mixed ON = Pt 100 and Pt 1000 sensors, also mixed
01	Sensor input F1 (deviating from Fb00)	OFF	0...9	ON = Select: n1000 (Ni1000), ni200, ntC, PtC, P1000 (Pt 1000), Pt100, 4-20 (mA), 0-20 (mA) Connect a 50 Ω resistance in parallel for current signals!
02	Sensor input F2 (deviating from Fb00)	OFF	0...9	
03	Sensor input F3 (deviating from Fb00)	OFF	0...9	
04	Sensor input F4 (deviating from Fb00)	OFF	0...9	
05	Sensor input F5 (deviating from Fb00)	OFF	0...9	
06	Sensor input F6 (deviating from Fb00)	OFF	0...9	
07	Sensor input F7 (deviating from Fb00)	OFF	0...9	
08	Sensor input F8 (deviating from Fb00)	OFF	0...9	
09	Sensor input F9 (deviating from Fb00)	OFF	0...9	
10	Sensor input F10 (deviating from Fb00)	OFF	0...9	
11	Sensor input F11 (deviating from Fb00)	OFF	0...9	
12	Sensor input F12 (deviating from Fb00)	OFF	0...9	
13	Sensor input 13 (deviating from Fb00)	OFF	0...9	
23	Sensor calibration <i>see p. 53</i>	OFF	0...9	ON

Appendix A.7 Configuration level Co7 for LON communication

Fb	Function	WE	Anl.	Comments
00	LON s. S. 79	OFF	0...9	ON = LON interface active OFF = LON interface not active
01	Primary controller see p. 79	OFF	0...9	ON = Controller function as primary controller
02	System time see p. 79	OFF	0...9	ON = System time for all controllers in a network
03	Outdoor temp. 1 see p. 79	OFF	0...9	ON = Send LON outdoor temperature 1, select: terminal for outdoor temperature (18...30)
04	Outdoor temp.2 see p. 79	OFF	0...9	ON = Send LON outdoor temperature 2, select: terminal for outdoor temperature (18...30)

Appendix A.8 Configuration level Co8 for error initialization

Fb	Function	WE	Anl.	Comments
01	BE01 in status register FSR see p. 85	OFF	0...9	ON = select STEIG/FALL STEIG: entry in FSR for rising signal, make contact FALL: entry in FSR for negative signal, break contact Note: Can only be changed after entering the key code! See p. 30
02	BE02 in status register FSR see p. 85	OFF	0...9	
03	BE03 in status register FSR see p. 85	OFF	0...9	
04	BE04 in status register FSR see p. 85	OFF	0...9	
05	BE05 in status register FSR see p. 85	OFF	0...9	
06	BE06 in status register FSR see p. 85	OFF	0...9	
07	BE07 in status register FSR see p. 85	OFF	0...9	
08	BE08 in status register FSR see p. 85	OFF	0...9	

Fb	Function	WE	Anl.	Comments
09	BE09 in status register FSR see p. 85	OFF	0...9	ON = select StEIG/FALL StEIG: entry in FSR for rising signal, make contact FALL: entry in FSR for negative signal, break contact Note: Can only be changed after entering the key code! See p. 30
10	BE10 in status register FSR see p. 85	OFF	0...9	
11	BE11 in status register FSR see p. 85	OFF	0...9	
12	BE12 in status register FSR see p. 85	OFF	0...9	
13	BE13 in status register FSR see p. 85	OFF	0...9	

Appendix A.9 Configuration level Co9 for Modbus communication

Fb	Function	WE	Anl.	Comments
00	Modbus	OFF	0...9	ON = Modbus active; only when Co9 Fb06 = OFF, Fb10 = OFF
01	Modem	OFF	0...9	ON = Modem active
02	Modem dialing procedure	OFF	0...9	ON = Pulse, OFF = Multi-frequency
03	Block dialing	OFF	0...9	ON = No call when error occurs
04	Modbus addressing	OFF	0...9	ON = 16 bit; OFF = 8 bit
06	SMS ¹⁾ error message to a mobile phone	OFF	0...9	ON = Error message to a mobile phone; only when Co9 Fb00 = OFF, Fb10 = OFF
07	SMS dialing procedure	OFF	0...9	ON = Pulse, OFF = Multi-frequency
10	Error message to a fax	OFF	0...9	ON = Error message to a fax machine
11	Fax dialing procedure	OFF	0...9	ON = Pulse, OFF = Multi-frequency

¹⁾ SMS = short message service

Appendix B Parameters

These parameters are set in levels PA1 to PA9.

Appendix B.1 Parameters set in PA1 level

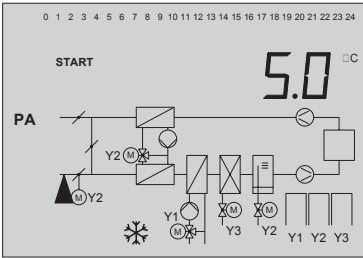
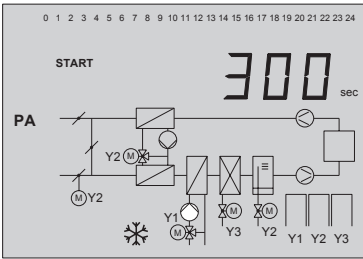
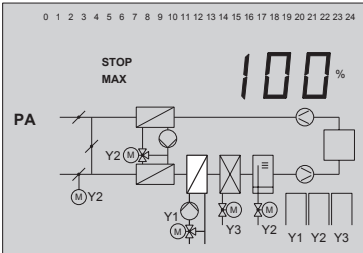
Symbols with default settings	Parameter name (range of values)	After pressing the enter key
	<p>System start-up mode when the outdoor temperature is lower (0 to 10 °C)</p> <p>Only for Anl 0 to 6, 8, 9 with outdoor temperature feedforwarding</p> <p>See <i>outdoor temperature-dependent system start-up mode</i> p. 70</p>	
	<p>Pump advance running time for start-up (0 to 15 min)</p> <p>Anl 0 to 6, 8, 9</p> <p>See <i>system start-up mode</i> on p. 70</p>	
	<p>Control signal limit for Y1 (0 to 100 %)</p> <p>Anl 0 to 6, 8, 9</p> <p>See <i>system start-up mode</i> on p. 70</p>	

Symbols with default settings

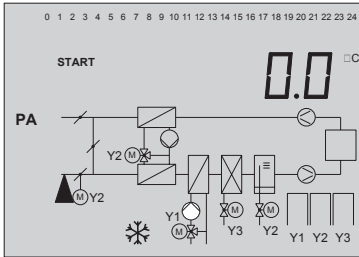
Parameter name
(range of values)After pressing
the enter key

Pump ON when the outdoor temperature is lower

(-50 to 10 °C)

Only for AnI 0 to 6, 8, 9 with feedforwarding of outdoor temperature

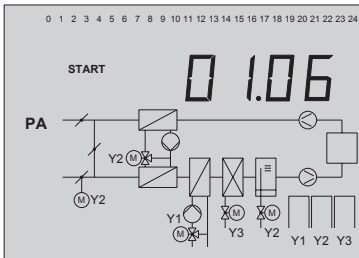
See stand-by monitoring on p. 77, stand-by control on p. 78

Date when summer deactivation is enabled

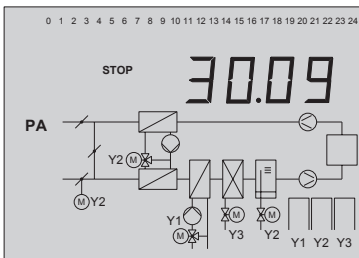
AnI 0 to 9;
For AnI 7 only when Fb10 = ON*See summer deactivation on p. 68 and night purge on p. 73*

Date when summer deactivation is disabled

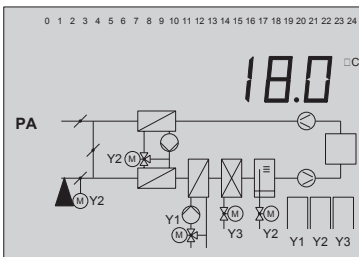
See summer deactivation on p. 68 and night purge on p. 73

Outdoor mean temperature

(0 to 30 °C)

See summer deactivation on p. 68 and night purge on p. 73

Symbols with default settings

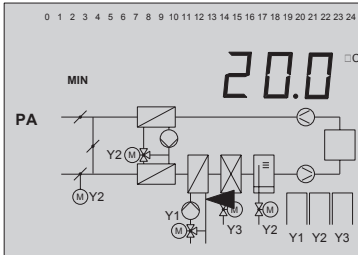
Parameter name
(range of values)After pressing
the enter key

Return air temperature minimum limit

(0 to 100 °C)

Only for An1 0 to 6, 8, 9 with return air sensor

See return air temperature limit on p. 74 and
stand-by control on p. 78

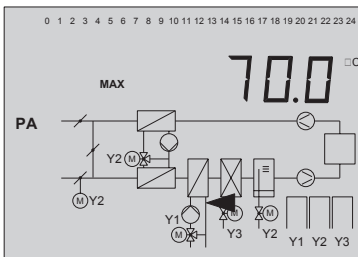

Return air temperature maximum limit

(0 to 100 °C)

Only for An1 0 to 6, 8, 9 with return air sensor, without feedforwarding of outdoor temperature

See return air temperature limit on p. 74 and return air
temperature-controlled system start-up mode on p.70

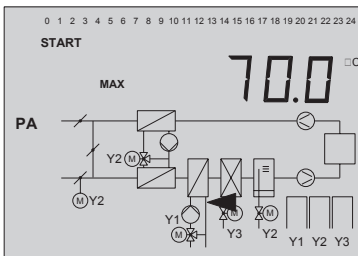

Return air temperature maximum limit coordinate 1

(0 to 100 °C)

Only for An1 0 to 6, 8, 9 with feedforwarding of return air and outdoor temperature

See variable return air temperature maximum limit on p. 75,
return air temperature-controlled system start-up mode on
p. 70

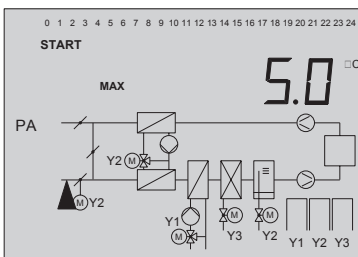

Outdoor temperature coordinate 1

(-50 to 20 °C)

Only for An1 0 to 6, 8, 9 with feedforwarding of return air and outdoor temperature

See variable return air temperature maximum limit on p. 75,
return air temperature-controlled system start-up mode on
p. 70

Symbols with default settings

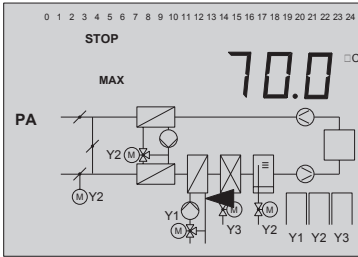
Parameter name
(range of values)After pressing
the enter key

Return air temperature maximum limit coordinate 2

(0 to 100 °C)

Only for AnI 0 to 6, 8, 9 with feedforwarding of return air and outdoor temperature

See variable return air temperature maximum limit on p. 75, return air temperature-controlled system start-up mode on p. 70

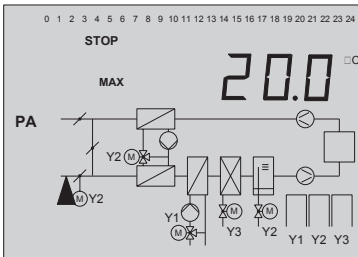

Outdoor temperature coordinate 2

(-50 to 40 °C)

Only for AnI 0 to 6, 8, 9 with feedforwarding of return air and outdoor temperature

See variable return air temperature maximum limit on p. 75, return air temperature-controlled system start-up mode on p. 70

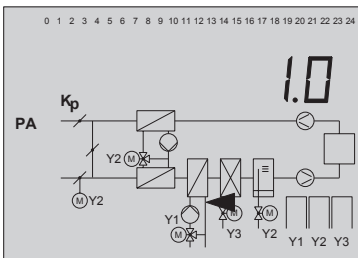

Return air temperature limit factor

(0 to 10)

Only for AnI 0 to 6, 8, 9 with return air sensor

See variable return air temperature maximum limit on p. 75, return air temperature-controlled system start-up mode on p. 70

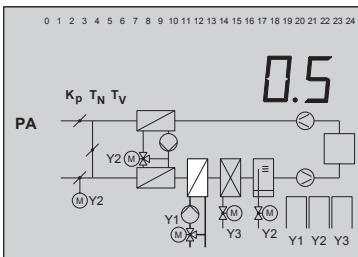
K_p Heating coil (0.1 to 99.9)

T_N Heating coil [60] AnI 0 to 6 and 8, 9
(1 to 999 sec)

T_V Heating coil [- - -] (- - - to 999 sec)

See p. 60

Appendix B.2 Parameters set in PA2 level

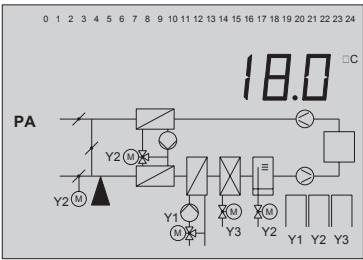
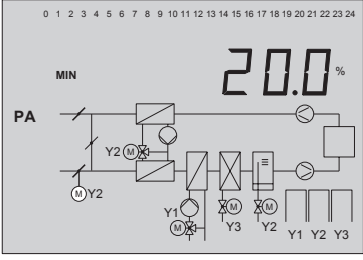
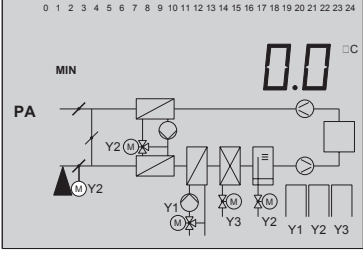
Symbols with default settings	Parameter name (range of values)	After pressing the enter key
	Mixed air temperature set point (10 to 30 °C) Anl 2, 4 only with mixed air temperature sensor	<i>See independent mixed air temperature control on p. 62</i>
	Minimum outdoor air rate (0 to 100 %) Anl 2, 4, 8 only	<i>See mixed air chamber on p. 61, summer time operation on p. 68 and air quality control on p. 73</i>
	Minimum outdoor air rate at an outdoor temperature is lower (-10 to 50 °C) Anl 2, 4, 8 only with outdoor temperature-controlled mixed air chamber	<i>See outdoor temperature-controlled mixed air chamber on p. 63</i>

Symbols with default settings

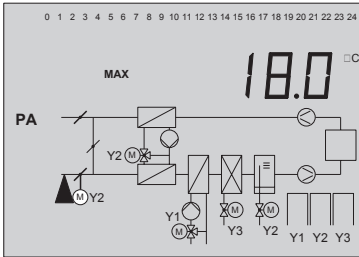
Parameter name
(range of values)After pressing
the enter key

100 % outdoor air when the outdoor temperature is greater

(-10 to 50 °C)

An1 2, 4, 8 with outdoor temperature-controlled mixed air chamber only

See outdoor temperature-controlled mixed air chamber on p. 63

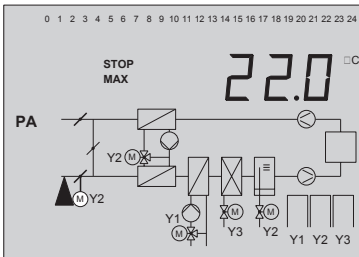

Summer time operation when the outdoor temperature is greater

(0 to 40 °C)

An1 2, 4, 8 with feedforwarding of outdoor temperature only

See summer time operation on p. 68

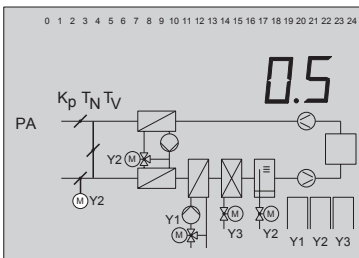

K_p Mixed air chamber (0.1 to 99.9)

T_N Mixed air chamber [60] (1 to 999 sec)

T_V Mixed air chamber [- - -] (- - - to 999 sec)

An1 2, 4, 8 only, however, not with outdoor temperature-controlled mixed air chamber

See mixed air chamber on p. 61

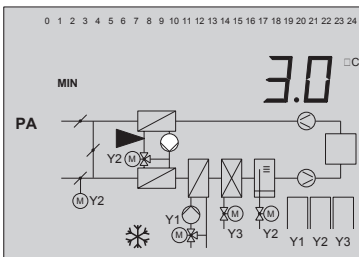

Heat recovery minimum temperature

(1 to 10 °C)

An1 3, 5 with F6 only

See frost protection HRU on p. 77

Symbols with default settings

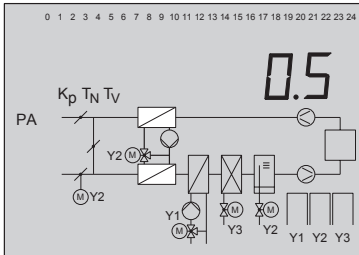
Parameter name
(range of values)After pressing
the enter key

K_p Heat recovery unit (0.1 to 99,9)
 T_N Heat recovery unit [60] (1 to 999 sec)
 T_V Heat recovery unit [- - -] (- - - to 999 sec)

Anl 3, 5, 9 only

See heat recovery unit on p. 64

Appendix B.3 Parameters set in PA3 level

Symbols with default settings

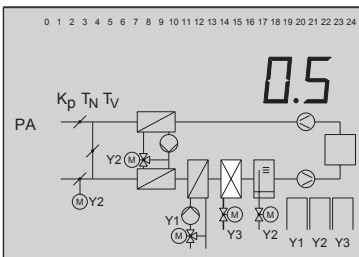
Parameter name
(range of values)After pressing
the enter key

K_p Cooling coil (0.1 to 99.9)
 T_N Cooling coil [60] (1 to 999 sec)
 T_V Cooling coil [- - -] (- - - to 999 sec)

Anl 1 and 4 to 9 only

See cooling coil control output on p. 64

Appendix B.4 Parameters set in PA4 level

Symbols with default settings

Parameter name (range of values)

After pressing the enter key

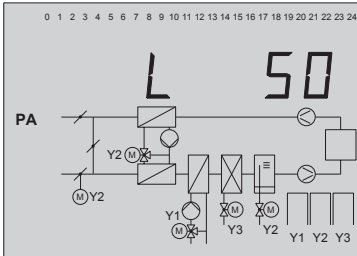

Air quality set point

(0 to 100)

Only with feedforwarding of air control

*See air quality control via mixed air chamber on p. 73,
fan speed dependent on the air quality on p. 58,
air volume dependent on the air quality on p. 66*

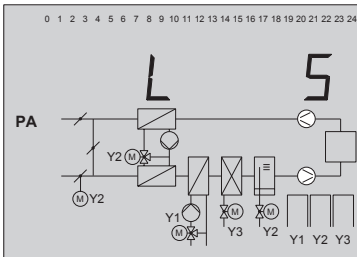

Differential gap of speed 2 ->1

(5 to 30)

Only with feedforwarding of air control in systems with 2-speed fans

See fan speed dependent on the air quality on p. 58

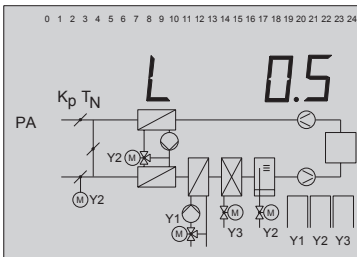

K_p Air quality control (0.1 to 99.9)

T_N Air quality control [60] (1 to 999 sec)

Only with feedforwarding of air control in An1 2, 4, 8; all other systems, with variable air volume control

*See Air quality control via mixed air chamber on p. 73 and
air volume dependent on the air quality on p. 66*

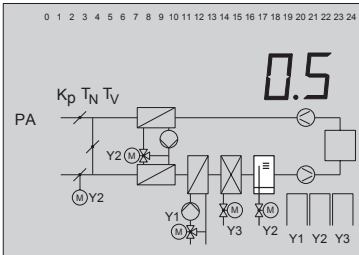

K_p Humidifier [0.5] (0.1 to 99.9)
 T_N Humidifier [60] (1 to 999 sec) (display not shown!)
 T_V Humidifier [- -](- - - to 999 sec) (display not shown!)

Note: For Anl 8, 9 the humidifier is assigned to analog output Y4, not control output Y2 as shown on the display

Anl 6, 8, 9 only

See humidifier on p. 64

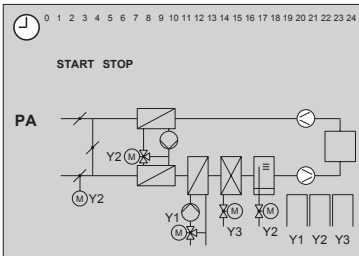

Times-of-use for fan speed 2

(two time schedules with adjustable start and stop)

Default setting:

10:00...12:00 and 12:00...15:00

Appendix B.5 Parameters set in PA5 level

Symbols with default settings

Parameter name
(range of values)

After pressing
the enter key

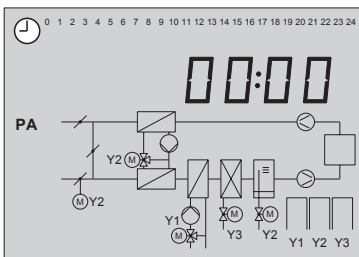

Time

Symbols with default settings

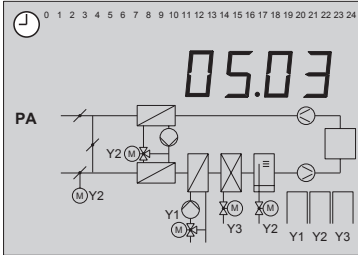
Parameter name
(range of values)After pressing
the enter key

Date

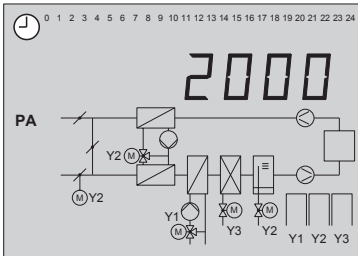

Year

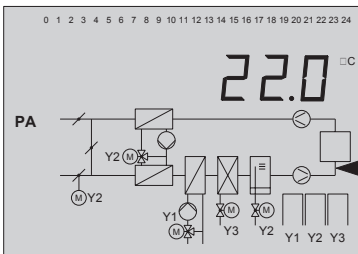

Supply air temperature day set point

(0 to 50 °C)

Only with supply air temperature control

See p. 48

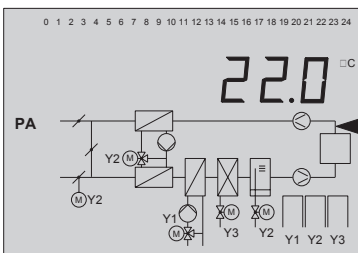

Exhaust air temperature day set point

(0 to 40 °C)

Only with exhaust air temperature control or exhaust air temperature cascade control

See p. 48, 49

Symbols with default settings

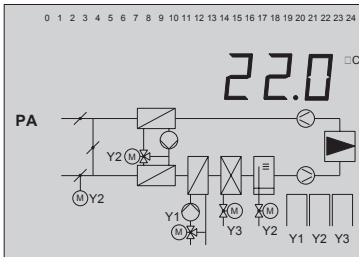
Parameter name
(range of values)After pressing
the enter key

Room temperature day set point

(0 to 40 °C)

With room temperature control or room temperature cascade control

See p. 50, p. 75

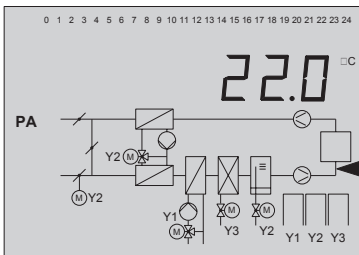

Temperature set point slave loop

(0 to 50 °C)

Only with cascade control

See p. 49, 50

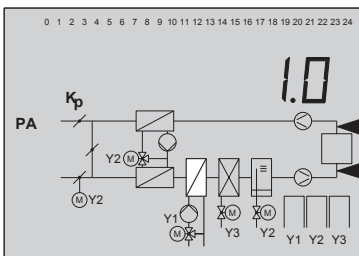
 K_p Temperature master loop

(0.1 to 99.9)

Only with cascade control

See p. 49, 50

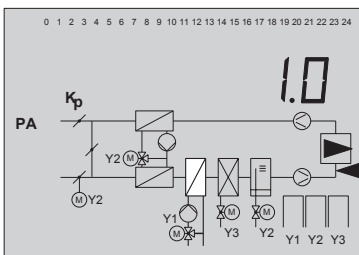

or

See p. 49, 50

Symbols with default settings

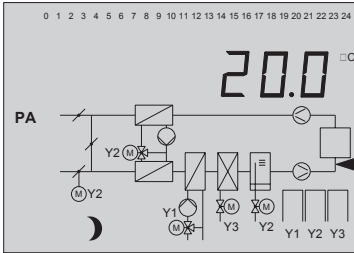
Parameter name
(range of values)After pressing
the enter key

Supply air temperature night set point

(0 to 50 °C)

Only with supply air temperature control

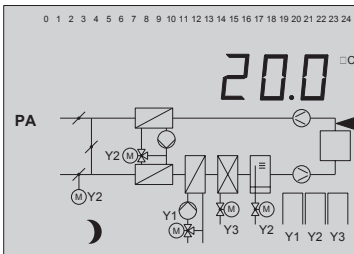
See p. 48

Exhaust air temperature night set point

(0 to 40 °C)

With exhaust air temperature control or exhaust air temperature cascade control

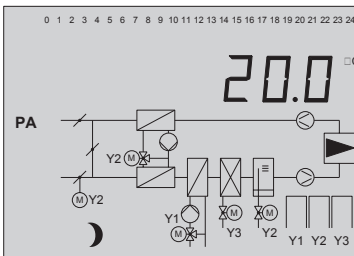
See p. 48, 49

Room temperature night set point

(0 to 40 °C)

With room temperature control or room temperature cascade control

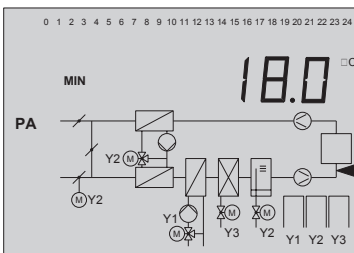
See p. 50, p. 75

Supply air temperature minimum limit

(0 to 50 °C)

Only with feedforwarding of supply air temperature

See supply air temperature limit on p. 74

Symbols with default settings

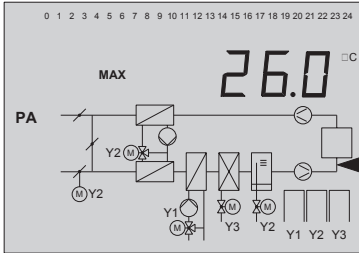
Parameter name
(range of values)After pressing
the enter key

Supply air temperature maximum limit

(0 to 50 °C)

Only with feedforwarding of supply air temperature

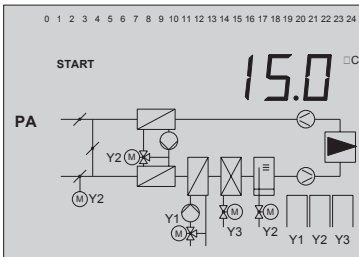
See supply air temperature limit on p. 74

Sustained room temperature

(0 to 20 °C)

Only with An1 0 to 6, 8, 9 with feedforwarding of room temperature

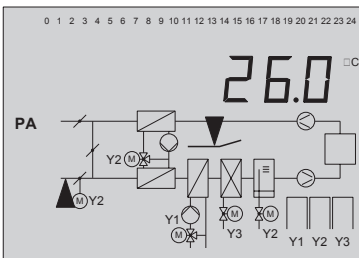
See sustained room temperature on p. 72

Summer compensation when the outdoor temperature is greater

(-50 to 40 °C)

Only with An1 0, 1 and 4 to 9 with outdoor temperature

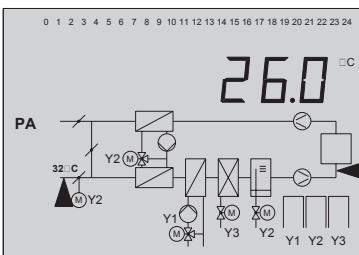
See summer compensation on p. 71

Set point at an outdoor temperature of 32 °C

Supply air temperature

(0 to 40 °C)

Only with An1 0, 1 and 4 to 9 with outdoor temperature

See summer compensation on p. 71

Symbols with default settings

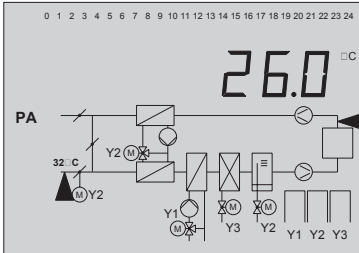
Parameter name
(range of values)After pressing
the enter key

or set point at an outdoor temperature of 32 °C
Exhaust air temperature

See summer compensation on p. 71

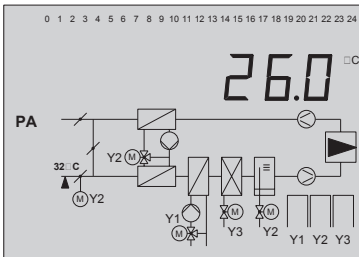

or set point at an outdoor temperature of 32 °C
Room temperature

See summer compensation on p. 71

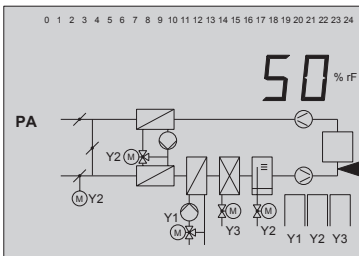

Supply air humidity set point

(0 to 100 % rH)

Anl 6, 8, 9 only
only with supply air humidity control

See supply air humidity control on p. 51

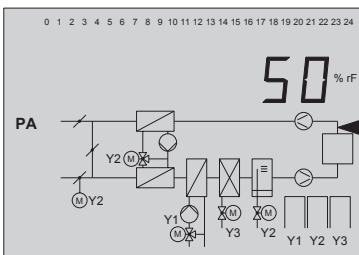

Exhaust air humidity set point

(0 to 100 % rH)

Anl 6, 8, 9 only

Only with exhaust air humidity control or exhaust air humidity cascade control

See exhaust air humidity control and exhaust air humidity cascade control on p. 31

Symbols with default settings

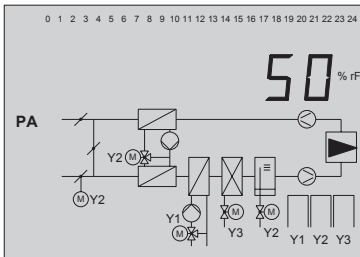
Parameter name
(range of values)After pressing
the enter key

Room humidity set point

(0 to 100 % rH)

Only Anl 6, 8, 9 with room humidity control or room humidity cascade control or fan operation dependent on room humidity

See room humidity control on p. 51 and room humidity cascade control on p. 52, fan operation dependent on room humidity on p. 75

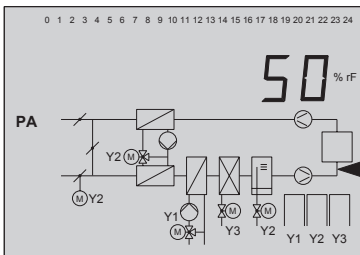

Humidity set point slave loop

(0 to 100 % rH)

Anl 6, 8, 9 with cascade control only

See exhaust air or room humidity cascade control on p. 52

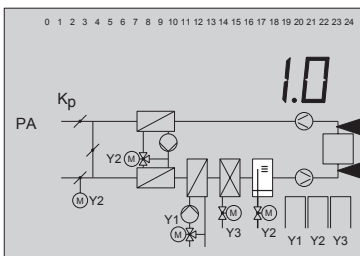
K_p Humidity master loop

(0.1 to 99.9)

Anl 6, 8, 9 with cascade control only

See exhaust air or room humidity cascade control on p. 52

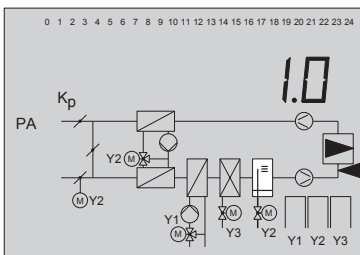

or

See exhaust air or room humidity cascade control on p. 52

Symbols with default settings

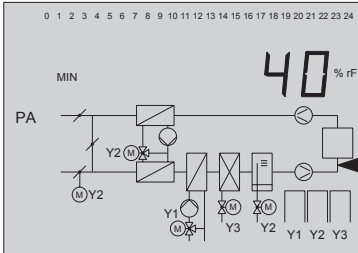
Parameter name
(range of values)After pressing
the enter key

Supply air humidity minimum limit

(0 to 100 % rH)

An1 6, 8, 9 with feedforwarding of supply air humidity

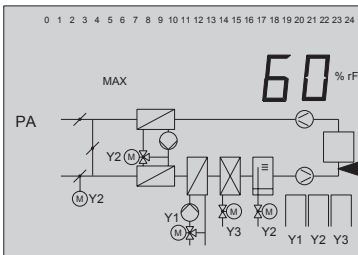
See supply air humidity limit on p. 75

Supply air humidity maximum limit

(0 to 100 % rH)

An1 6, 8, 9 with feedforwarding of supply air humidity only

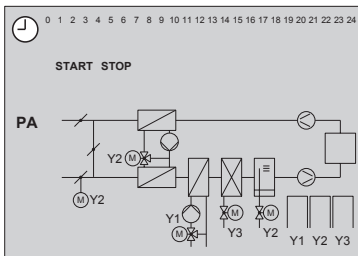
See supply air humidity limit on p. 75

Times-of-use

(Two time schedules with adjustable start and end

Default setting:
7:00...12:00 and
12:00...22:00*See p. 69*

In blocks or individual days

1-7 (Monday ... Sunday);

1-5 (Monday ... Friday)

6-7 (Saturday and Sunday);

1, 2, ... , 7 (Mon, Tue, ... ,

Sun)

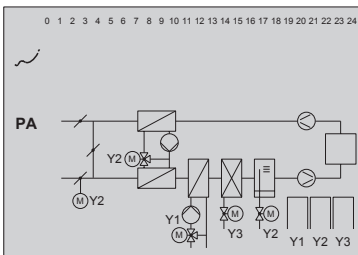

Public holidays

Standard public holidays:

01.01, 01.05, 25.12, 26.12

(maximum 20 public holidays adjustable)

The times-of-use for Sunday are

valid on public holidays

See p. 69

Symbols with default settings

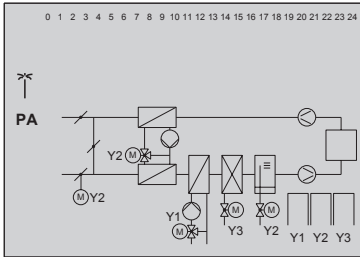
Parameter name
(range of values)After pressing
the enter key

Vacations

Starting and finishing dates
(START, STOP)

Standard vacation: - - - -
(none) (maximum 10 vacation
periods adjustable)
In vacation periods, the ventila-
tion system is switched off!

See p. 69

Appendix B.6 Parameters set in PA7 level (LON communication)

Symbols with default settings

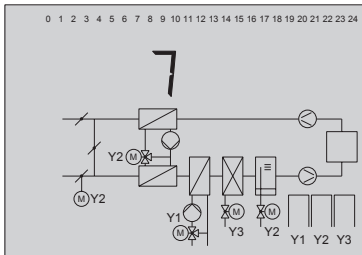
Parameter name
(range of values)After pressing
the enter key

Station address

(1 ... 20)

See p. 79

Appendix B.7 Parameter der Ebene PA9 (Modbus)

Symbols with default settings

Parameter name
(range of values)

After pressing
the enter key

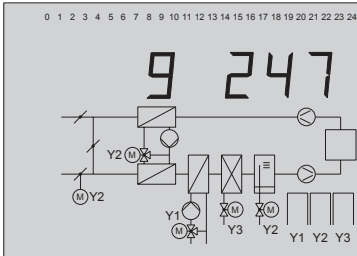

Station number

(1 to 247)

See p. 83

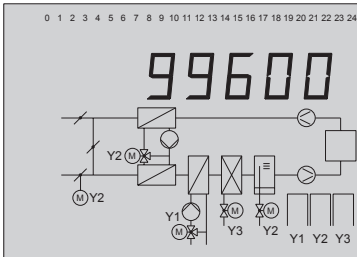

Baud rate

(150, 300, 600, 1200, 2400,
4800, 9600)

See p. 84

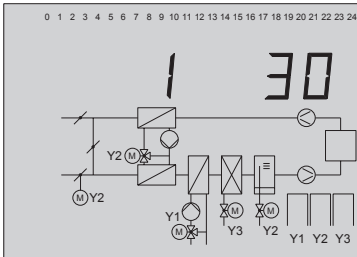

Cyclic initialization

(0 ... 255 min)

See p. 84

Symbols with default settings

Parameter name
(range of values)

After pressing
the enter key

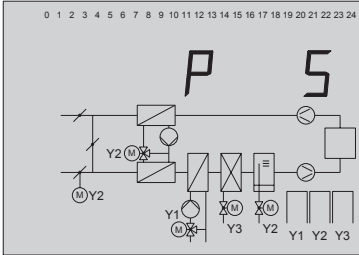

Modem dialing interval for calls to the control station
(1 ...255 min)

See p. 84

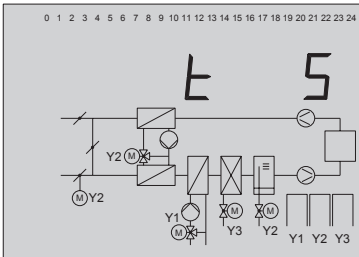

Modem timeout
(1 ... 255 min)

See p. 84

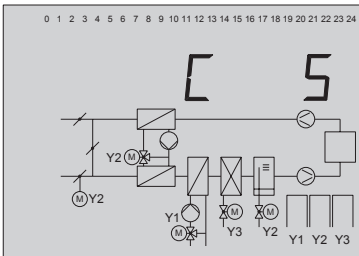

Number of dialing attempts to control station
(0 ... 99)

See p. 84

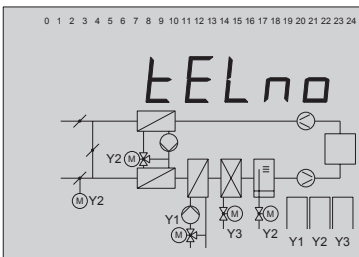

Phone number of control station (GLT)
or its fax

(max. 23 characters: 0 ... 9, P (pause), - (end of phone number))

See p. 84

Symbols with default settings

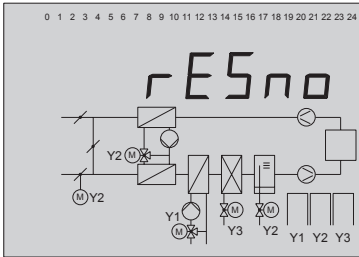
Parameter name
(range of values)After pressing
the enter key

Phone number of the alternative recipient

(max. 23 characters: 0 ... 9, P (pause), - (end of phone number))

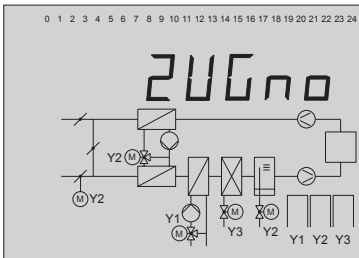
See p. 84

Access number (D1 or Eplus network)

(max. 23 characters: 0 ... 9, P (pause), - (end of phone number))

Only when an error message is sent to a mobile phone

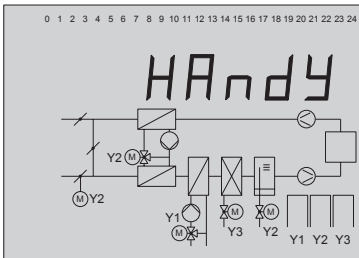
See p. 82

Mobile phone number

(max. 23 characters: 0 ... 9, P (pause), - (end of phone number))

Only when an error message is sent to a mobile phone

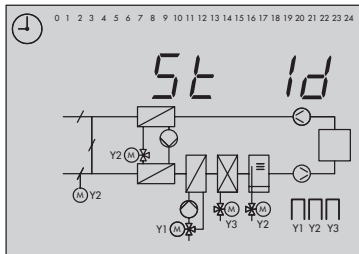
See p. 82

Station identification

optionally with connection to a fax machine

See p. 84

Appendix C Operating level

Appendix C.1 Info level InF1

Display shows

Parameter

After pressing
the enter key

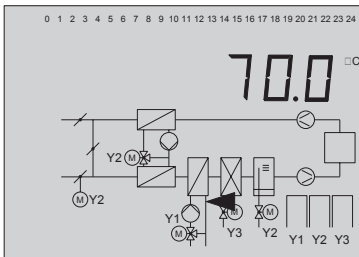

Return air temperature of heating coil

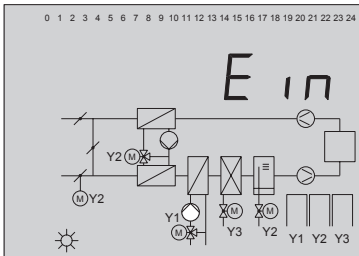

Pump of heating coil

(ON/OFF)

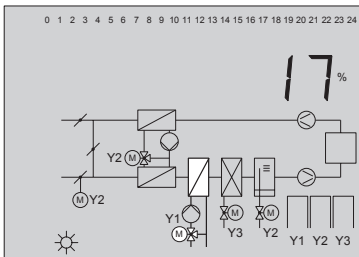

Control signal output of heating coil

Appendix C.2 Info level InF2

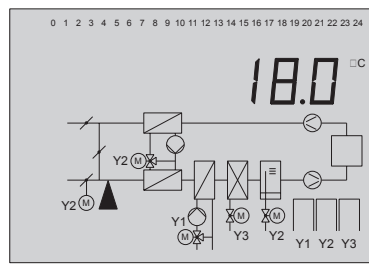
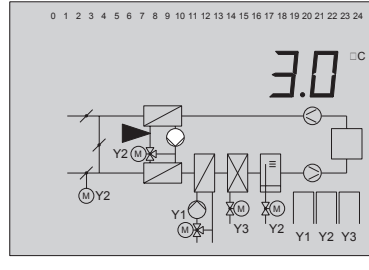
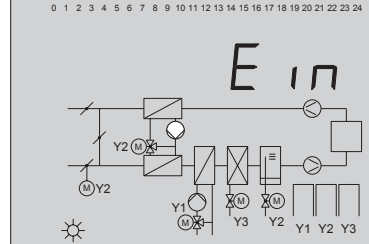
Display shows	Parameter	After pressing the enter key
	<p>Mixed air temperature</p>	
	<p>Temperature HRU</p>	
	<p>Pump of heat recovery (ON/OFF)</p>	

Display shows

Parameter

After pressing
the enter key

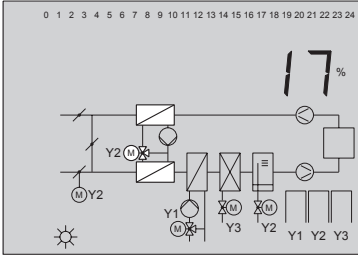

Control signal output of heat recovery or mixed air chamber

Appendix C.3 Info level InF3

Display shows

Parameter

After pressing
the enter key

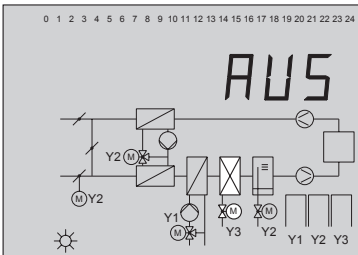

Binary output BA6

(ON/OFF)

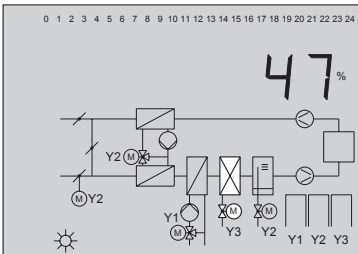

Control signal output of cooling coil

Appendix C.4 Info level InF4

Display shows

Parameter

After pressing
the enter key

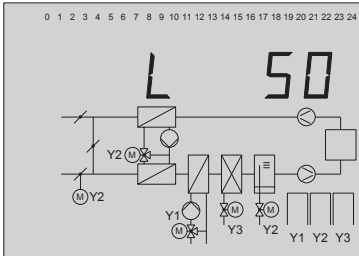

Measured air quality

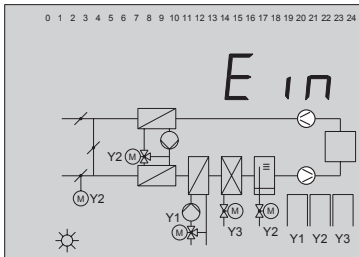

Fans

(ON/OFF or
with two-speed fans: ON1, ON2, OFF or
with speed-controlled fans: 0...100 %)

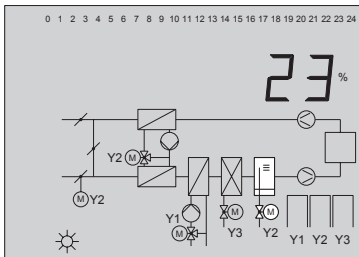

Control signal output of humidifier

Appendix C.5 Info level InF5

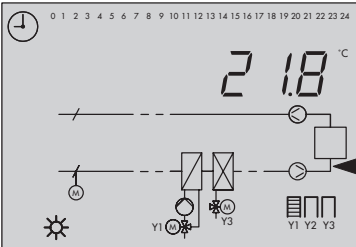
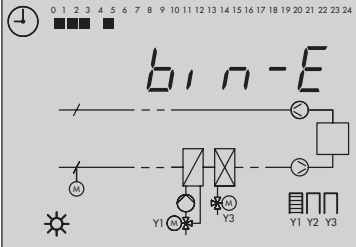
Display shows	Parameter	After pressing the enter key
	<p>Supply air temperature (with supply air temperature control)</p> <p>Depending on the system code number and the control method, press the arrow key ↓ for further current values. Observe the arrow on the display.</p>	<p>Set point(s)</p>
	<p>Binary inputs</p> <p>Activated binary inputs are indicated by squares that appear under the number at the top of the display.</p>	<p>Binary outputs (bin-A)</p> <p>(same as binary inputs)</p>

Appendix D Resistance values of temperature sensors

Resistance thermometers with Pt 1000 measuring element

(Use the resistance values listed in the table for Pt 100 and multiply them by 10).

Sensor for outdoor temperature: Type 5227 for outside walls of buildings;

Sensor for heating coil return air temperature and HRU circuit temperature: Type 5207-21 (immersion sensor with brass sensor shaft), Type 5277 (duct sensor, thermowell required), Type 5267 (contact sensor);

Sensor for room temperature: Type 5257-1;

Sensor for room temperature and potentiometer 1000 to 2000 Ω : Type 5257-2;

Sensor for room temperature, potentiometer 1000 to 2000 Ω and external request for operation/speed 2 : Type 5257-6

Sensor for outdoor, supply air, exhaust air and mixed air temperature: Type 5217 (duct sensor)

Resistance thermometers with Pt 100 measuring element

Sensor for outdoor temperature: Type 5225 (for outside walls of buildings);

Sensor for heating coil return air temperature and HRU circuit temperature: Type 5204-21 (immersion sensor with brass sensor shaft), Type 5205-47 (immersion sensor with CrNiMo sensor shaft);

Sensor for room temperature: Type 5255;

Sensor for outdoor, supply air, exhaust air and mixed air temperature: Type 5215 (duct sensor)

°C	-35	-30	-25	-20	-15	-10	-5	0	5	1
Ω	86.25	88.22	90.19	92.16	94.12	96.09	98.04	100.00	101.95	103.90
°C	15	20	25	30	35	40	45	50	55	60
Ω	105.85	107.79	109.73	111.67	113.61	115.54	117.47	119.40	121.32	123.24
°C	65	70	75	80	85	90	95	100	105	110
Ω	125.16	127.07	128.98	130.89	132.80	134.70	136.60	138.50	140.39	142.29
°C	115	120	125	130	135	140	145	150		
Ω	144.17	146.06	147.94	149.82	151.70	153.58	155.45	157.31		

Resistance thermometers with PTC measuring element

Sensor for outdoor temperature: Type 5224 (for outside walls of buildings);

Sensor for heating coil return air temperature and HRU circuit temperature: Type 5264 (duct sensor, thermowell required) and Type 5265 (strap-on sensor)

°C	-20	-10	0	+10	+20	+25	+30	+40	+50	+60	+70	+80	+90	+100	+110	+120
Ω	694	757	825	896	971	1010	1050	1132	1219	1309	1402	1500	1601	1706	1815	1925

Hygrometer

Hygrometer for supply air humidity and exhaust air humidity: Type 5232-5 (duct hygrometer)

Hygrometer for room humidity: Type 5242-5

Differential pressure switch for fan operation feedback: Type 5335

Temperature monitor thermostat for system frost protection: Type 5312-2

Appendix E Customer data

Station	
Operator	
Responsible SAMSON office	
System code number	

Function block settings

Co1

Fb	ON/OFF	Options selected, function block parameters
01		Flow requirement (MIN AA): [90] °C, Flow requirement (MAX AA): [90] °C, Change when Y1 (MIN): [10] °C, Change when Y1 (MAX): [90] °C
12		Activating value (START): 0 to 100 [30] %, Deactivating value (STOP): 0 to 100 [10] %
13		Valve running time TY: 12, 30, 45, 240 [90] sec
21		

Co2

Fb	ON/OFF	Options selected, function block parameters
21		

Co3

Fb	ON/OFF	Options selected, function block parameters
01		BE10/BE7, StEIG/FALL

Fb	ON/OFF	Options selected, function block parameters
12	OFF	Enabling the cold storage at outdoor temperature (START): [18] °C
	ON	SEQ Activating value (START): [30] %; Deactivating value (STOP): [10] % Par Minimum activated time (START MIN): [600] sec; Minimum deactivated time (STOP MIN): [600] sec; Deactivate cooling at Y1 > (STOP): [50] %
21		

Co4

Fb	ON/OFF	Options selected, function block parameters
01		Delay time (START): [180] sec
02		Speed 2: BA4 = BA5 = ON or BA4 = OFF, BA5 = OFF Delay time: [0] sec
03		BE10 or BE7
04		Minimum air flow volume (MIN AA): [25] %; Factor of change (K _p): [0.0] (only with cascade control)
20		
21		
22		

Co5

Fb	ON/OFF	Options selected, function block parameters
01		
02		
03		Lon1, Lon2, —
04		
05		
06		
07		Mixed air temperature control Sequential operation with outgoing air temperature; Sequential operation with exhaust air temperature Outdoor temperature-controlled mixed air chamber operation

Fb	ON/OFF	Options selected, function block parameters
08		
09		
13		
15		
16		
17		Enable night purge (START): [24] °C Finish night purge (STOP): [18] °C Temperature difference to outdoor temperature: [5] °C
18	Assignment AE1	F1 Lower measuring range value MIN [-40] °C Upper measuring range value MAX [+50] °C F3 Lower measuring range value MIN [-40] °C Upper measuring range value MAX [+50] °C L Lower measuring range value MIN [0] Upper measuring range value MAX [100]
19	Assignment AE2	F3 Lower measuring range value MIN [-40] °C Upper measuring range value MAX [+50] °C F6 Lower measuring range value MIN [0] % rH Upper measuring range value MAX [100] % rH L Lower measuring range value MIN [0] Upper measuring range value MAX [100]
20	Assignment AE3	F2 Lower measuring range value MIN [-40] °C Upper measuring range value MAX [+50] °C F3 Lower measuring range value MIN [-40] °C Upper measuring range value MAX [+50] °C F5 Lower measuring range value MIN [-40] °C Upper measuring range value MAX [+50] °C L Lower measuring range value MIN [0] Upper measuring range value MAX [100]
21	Assignment AE4	F3 Lower measuring range value MIN [-40] °C Upper measuring range value MAX [+50] °C F7 Lower measuring range value MIN [0] % rH Upper measuring range value MAX [100] % rH L Lower measuring range value MIN [0] Upper measuring range value MAX [100]
23		

Co6

Fb	ON/OFF	Options selected, function block parameters
00		
01		Ni1000, ni200, ntC, PtC,Pt 1000, Pt100, 4-20 (mA), 0-20 (mA)
02		Ni1000, ni200, ntC, PtC,Pt 1000, Pt100, 4-20 (mA), 0-20 (mA)
03		Ni1000, ni200, ntC, PtC,Pt 1000, Pt100, 4-20 (mA), 0-20 (mA)
04		Ni1000, ni200, ntC, PtC,Pt 1000, Pt100, 4-20 (mA), 0-20 (mA)
05		Ni1000, ni200, ntC, PtC,Pt 1000, Pt100, 4-20 (mA), 0-20 (mA)
06		Ni1000, ni200, ntC, PtC,Pt 1000, Pt100, 4-20 (mA), 0-20 (mA)
07		Ni1000, ni200, ntC, PtC,Pt 1000, Pt100, 4-20 (mA), 0-20 (mA)
08		Ni1000, ni200, ntC, PtC,Pt 1000, Pt100, 4-20 (mA), 0-20 (mA)
09		Ni1000, ni200, ntC, PtC,Pt 1000, Pt100, 4-20 (mA), 0-20 (mA)
10		Ni1000, ni200, ntC, PtC,Pt 1000, Pt100, 4-20 (mA), 0-20 (mA)
11		Ni1000, ni200, ntC, PtC,Pt 1000, Pt100, 4-20 (mA), 0-20 (mA)
12		Ni1000, ni200, ntC, PtC,Pt 1000, Pt100, 4-20 (mA), 0-20 (mA)
13		Ni1000, ni200, ntC, PtC,Pt 1000, Pt100, 4-20 (mA), 0-20 (mA)
23		

Co7

Fb	ON/OFF	Options selected, function block parameters
00		
01		
02		
03		Terminal:
04		Terminal:

Co8

Fb	ON/OFF	Options selected, function block parameters
01		StEIG/FALL
02		StEIG/FALL
03		StEIG/FALL
04		StEIG/FALL
05		StEIG/FALL
06		StEIG/FALL
07		StEIG/FALL
08		StEIG/FALL
09		StEIG/FALL
10		StEIG/FALL
11		StEIG/FALL
12		StEIG/FALL
13		StEIG/FALL

Co9

Fb	ON/OFF	Options selected, function block parameters
00		
01		
02		
03		
04		
06		
07		
10		
11		

Parameter settings

Parameters in PA1 level

Parameter		Unit	Range of values
Start-up mode when the outdoor temp. is lower		°C	0 to 10
Pump advance running time for start-up		min	0 to 15
Control signal limit for Y1		%	0 to 100
Pump ON when the outdoor temperature is lower		°C	-50 to 10
Date when summer deactivation is enabled			
Date when summer deactivation is disabled			
Outdoor mean temperature		°C	0 to 30
Return air temperature minimum limit		°C	0 to 100
Return air temperature maximum limit		°C	0 to 100
Return air temperature maximum limit Coordinate 1		°C	0 to 100
Outdoor temperature Coordinate 1		°C	-50 to 20
Return air temperature maximum limit Coordinate 2		°C	0 to 100
Outdoor temperature Coordinate 2		°C	-50 to 40
Return air temperature limit factor			0 to 10
K _p Heating coil			0.1 to 99.9
T _N Heating coil		sec	1 to 999
T _V Heating coil		sec	- - - to 999

Parameters in PA2 level

Parameter		Unit	Range values
Mixed air temperature set point		°C	10 to 30
Minimum outdoor air rate		%	0 to 100
Min. outdoor air rate when outdoor temp. is lower		°C	-10 to 50
100 % outdoor air when the outdoor temp. is greater		°C	-10 to 50
Summer time operation when the outdoor temp. is greater		°C	0 to 40

Parameter		Unit	Range values
K _p Mixed air chamber			0.1 to 99.9
T _N Mixed air chamber		sec	1 to 999
T _V Mixed air chamber		sec	- - - to 999
Heat recovery temperature		°C	1 to 10
K _p Heat recovery			0.1 to 99.9
T _N Heat recovery		sec	1 to 999
T _V Heat recovery		sec	- - - to 999

Parameters in PA3 level

Parameter		Unit	Range values
K _p Cooling coil			0.1 to 99.9
T _N Cooling coil		sec	1 to 999
T _V Cooling coil		sec	- - - to 999

Parameters in PA4 level

Parameter		Unit	Range values			
Air quality set point			0 to 100			
Differential gap of speed 2 ->1			5 to 30			
K _p Air quality control			0.1 to 99.9			
T _N Air quality control		sec	1 to 999			
K _p Humidifier			0.1 to 99.9			
T _N Humidifier		sec	1 to 999			
T _V Humidifier		sec	- - - to 999			
Times-of-use for fan speed 2	Start 1	Stop 1	Start 2	Stop2		In blocks or individual days; two times-of-use with start and stop times
Monday						
Tuesday						
Wednesday						
Thursday						
Friday						
Saturday						
Sunday						

Parameters in PA5 level

Parameter					Unit	Range of values
Supply air temperature day set point					°C	0 to 50
Exhaust air temperature day set point					°C	0 to 40
Room temperature day set point					°C	0 to 40
Temperature set point slave loop					°C	0 to 50
K _p Temperature master loop						0.1 to 99.9
Supply air temperature night set point					°C	0 to 50
Exhaust air temperature night set point					°C	0 to 40
Room temperature night set point					°C	0 to 40
Supply air temperature minimum limit					°C	0 to 50
Supply air temperature maximum limit					°C	0 to 50
Sustained room temperature					°C	0 to 20
Summer compensation when the outdoor temperature is greater					°C	-50 to 40
Set point at an outdoor temp. of 32 °C					°C	0 to 40
Supply air humidity set point					% rH	0 to 100
Exhaust air humidity set point					% rH	0 to 100
Room humidity set point					% rH	0 to 100
Humidity set point slave loop					% rH	0 to 100
K _p Humidity master loop						0.1 to 99.9
Supply air humidity minimum limit					% rH	0 to 100
Supply air humidity maximum limit					% rH	0 to 100
Times-of-use	Start 1	Stop 1	Start 2	Stop 2		In blocks or individual days; two times-of-use with start and stop times
Monday						
Tuesday						
Wednesday						
Thursday						
Friday						
Saturday						
Sunday						

Parameter		Unit	Range of values
Public holidays			(max. 20 days)
Vacations Starting date Finishing date			(max. 10 vacation periods)

Parameters in PA7 level

Parameter		Unit	Range of values
Station address			1...20

Parameters in PA9 level

Parameter		Unit	Range of values
Station number			1 to 247
Baud rate			150 to 9600
Cyclic initialization		min	0 to 255
Modem dialing interval		min	1 to 255
Modem timeout		min	1 to 255
Number of dialing attempts to control station			0 to 99
Phone number of control station/fax			0 to 9, P (pause), - (end)
Phone number of alternative recipient			
Access number (D1 or E Plus network)			
Mobile phone number			
Station identification			

Parameter		Unit	Range of values
Public holidays			(max. 20 days)
Vacations Starting date Finishing date			(max. 10 vacation periods)

Parameters in PA7 level

Parameter		Unit	Range of values
Station address			1...20

Parameters in PA9 level

Parameter		Unit	Range of values
Station number			1 to 247
Baud rate			150 to 9600
Cyclic initialization		min	0 to 255
Modem dialing interval		min	1 to 255
Modem timeout		min	1 to 255
Number of dialing attempts to control station			0 to 99
Phone number of control station/fax			0 to 9, P (pause), - (end)
Phone number of alternative recipient			
Access number (D1 or E Plus network)			
Mobile phone number			
Station identification			

Parameter		Unit	Range of values
Public holidays			(max. 20 days)
Vacations Starting date Finishing date			(max. 10 vacation periods)

Parameters in PA7 level

Parameter		Unit	Range of values
Station address			1...20

Parameters in PA9 level

Parameter		Unit	Range of values
Station number			1 to 247
Baud rate			150 to 9600
Cyclic initialization		min	0 to 255
Modem dialing interval		min	1 to 255
Modem timeout		min	1 to 255
Number of dialing attempts to control station			0 to 99
Phone number of control station/fax			0 to 9, P (pause), - (end)
Phone number of alternative recipient			
Access number (D1 or E Plus network)			
Mobile phone number			
Station identification			

Index

A

- Air quality 58, 66
- Air quality control
 - via mixed air chamber 73
- Air volume control 66
- Analog input
 - Air quality 58, 66, 73
 - Exhaust air humidity 51 - 52
 - Operating action 66
 - Room humidity 51 - 52
 - Supply air humidity 51 - 52
- Analog output
 - Air volume control 66
 - Humidifier 64
 - Request for externally required signal . 66
- Automatic operation 7
- Automatic reversal
 - HRU 64
 - Mixed air chamber 61
- Automatic summer time/winter time change-over 69, 98

B

- Baud rate 83
- Binary inputs
 - External demand for fan speed 2 54
 - External demand for operation 54
- Binary output
 - dependent on Y3 58
 - Fault alarm output 60

C

- Chiller 59
- Circulation pump
 - Heat recovery (HRU) 59
 - Heating coil 57
- Condensation detection 55

- Configuration levels 31
- Control method 48 - 52
 - setting
 - see setting of system code number
- Control signal limit 70
- Cooling coil 64
- Cyclic initialization 120

E

- Enabling fan speed 2 57
- Exhaust air cascade control 52
- Exhaust air humidity control 51
- Exhaust air temperature cascade control . 49
- Exhaust air temperature control 48
- External correction of the humidity set point 56
- External demand for fan speed 2 54
- External demand for operation 54
- External temperature set point correction . 56

F

- Fan speed 1 57
- Fan speed 2
 - dependent on air quality 57 - 58
 - Times-of-use 69
- Fault alarm output 60
- Frost protection
 - Heating coil 77
 - HRU 77
 - Outdoor temperature sensor 77 - 78
 - Return air temperature sensor 78
 - Stand-by monitoring 77
 - System 77
- Function block parameter
 - changing 32
- Function blocks 31

H		
Heat recovery	64	
Heating coil	60	
Humidifier	64	
I		
Installation		
Panel mounting	88	
Wall mounting	88	
K		
Key code	30	
L		
Locking settings	78	
LON	79	
M		
Malfunctions	76	
Manual operation	7	
Mixed air chamber	61	
Automatic reversal	61	
Independent mixed air temperature control	62	
Sequential operation	61	
Modbus addressing	102	
Modem dialing interval	84, 121	
N		
Night purge	73	
O		
On/off output for heating coil	59	
Operating action		
Control output Y2	61	
Outdoor air rate	61	
Operating level	123 - 127	
		Operation feedback
		Fans
		Outdoor air damper
		Outdoor air rate
		Operating action
		Outdoor mean temperature
		Outdoor temperature
		over LON
		Outdoor temperature sensor
		Outdoor temperature-controlled supply air control
		Outgoing air damper
		P
		Parallel operation
		Chiller
		Parameters
		changing
		Potentiometer
		Correction of humidity set point
		Correction of temperature set point
		Primary controller
		Pt 100 sensor
		Pt 1000 sensor
		PTC sensor
		Public holidays
		R
		Reduced operation
		Request for externally required signal
		Resistance values of temperature sensors
		- 129
		Return air flow temperature sensor
		Return air temperature limit
		variable
		Return air temperature sensor
		Room humidity cascade control
		Room humidity control
		Room humidity limit
		Room temperature cascade control

Room temperature control	50	Surge protection measures	90
RS 232 C interface	81	Sustained room temperature	72
RS-485 bus	86	Symbols on the display	147
S		System code number	
Sensor		changing	16
selecting type	53	System frost protection	77
Sensor calibration	53	System start-up mode	70
Sensor failure	76	Dependent on outdoor temperature . .	70
Sensor version	100	Return air temperature-controlled . . .	70
Sequential operation	61	T	
Serial interface	81 - 86	Technical data	93 - 94
Stand-by control	78	Telephone number	
Stand-by monitoring	77	Alternative recipient	84
Stand-by operation	7	Three-step output for heating coil	60
Station identification	84	Time	
Status register	85	over LON	79
Summer compensation	71	setting	22
Summer deactivation	68	V	
Summer time operation	68	Vacations	69
Supply air humidity control	51	Variable return air temperature maximum	
Supply air humidity limit	75	limit	75
Supply air temperature control	48		
Supply air temperature limit	74		

Key code

1732

Important symbols on the display

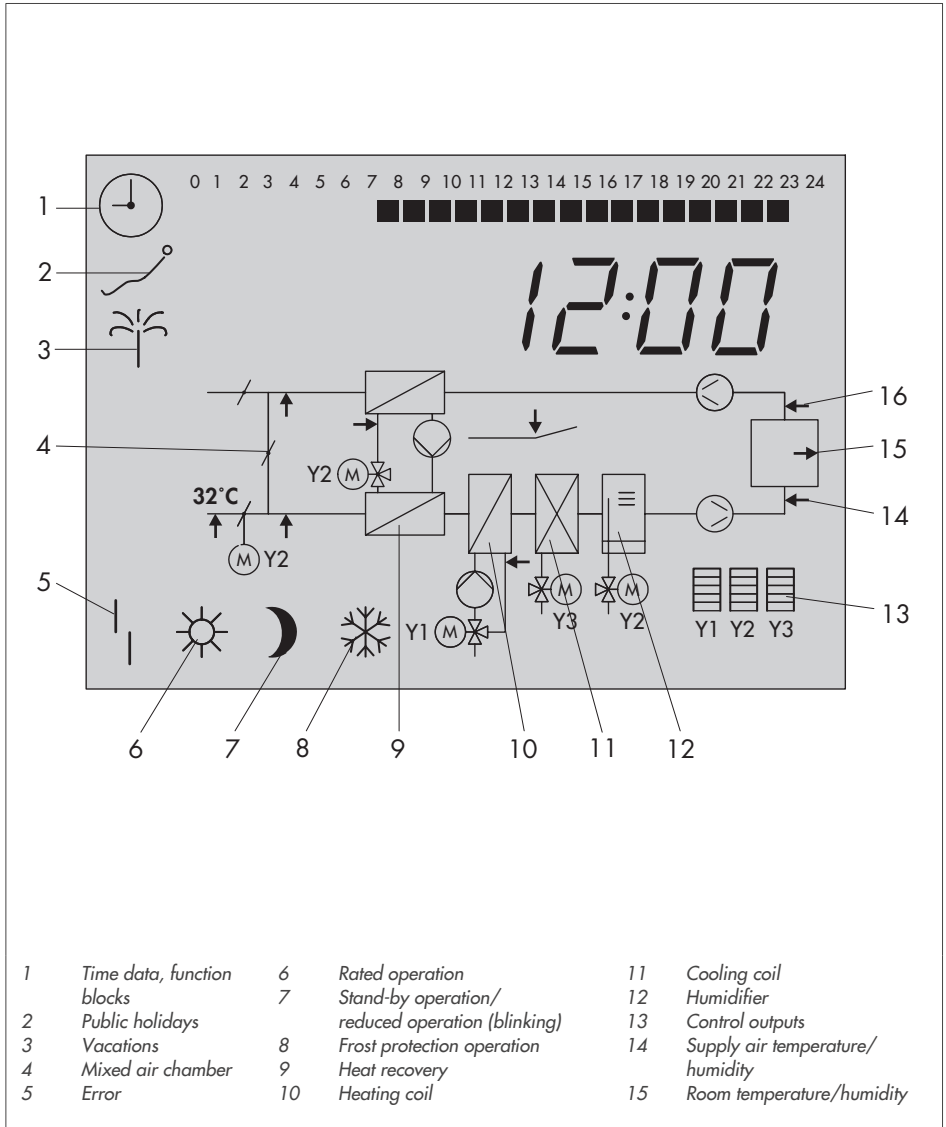

Front view

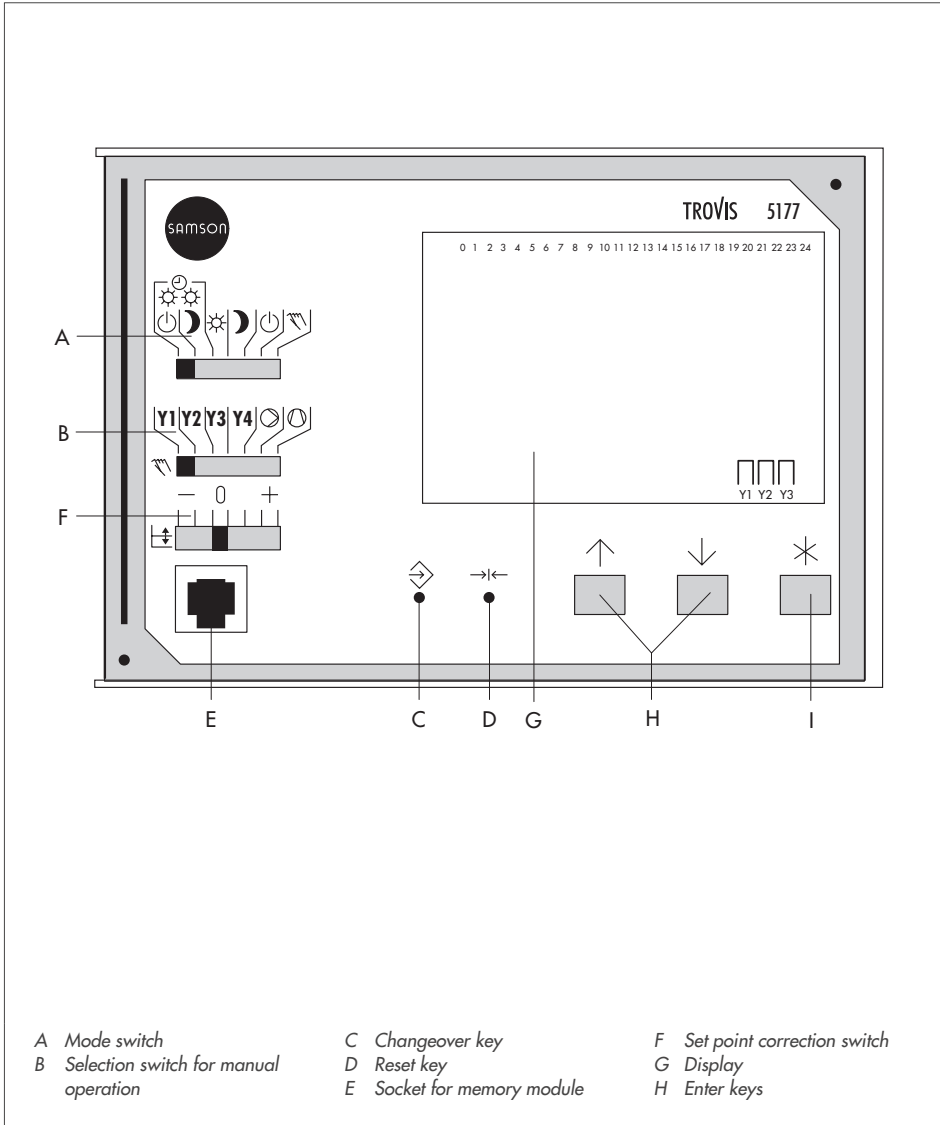



SAMSON AG · MESS- UND REGELTECHNIK
Weismüllerstraße 3 · 60314 Frankfurt am Main · Germany
Phone +49 69 4009-0 · Phone +49 69 4009-1507
Internet: <http://www.samson.de>

EB 5177 EN

S/2000-09

